

UNIVERSITY OF TORONTO

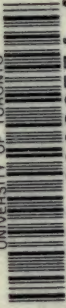

3 1761 00380574 4















## HARVARD ECONOMIC STUDIES

- I. The English Patents of Monopoly. By William H. Price. 8vo.
- II. The Lodging House Problem in Boston. By Albert B. Wolfe. 8vo.
- III. The Stannaries: A Study of the English Tin Miner. By George R. Lewis. 8vo.
- IV. Railroad Reorganization. By Stuart Daggett. 8vo.
- V. Wool-Growing and the Tariff. By Chester W. Wright. 8vo.
- VI. Public Ownership of Telephones on the Continent of Europe. By Arthur N. Holcombe. 8vo.
- VII. The History of the British Post Office. By J. C. Hemmeon. 8vo.
- VIII. The Cotton Manufacturing Industry of the United States. By M. T. Copeland. 8vo.
- IX. The History of the Grain Trade in France. By Abbott Payson Usher. 8vo.
- X. Corporate Promotions and Reorganizations. By A. S. Dewing. 8vo.
- XI. The Anthracite Coal Combination in the United States. By Eliot Jones. 8vo.
- XII. Some Aspects of the Tariff Question. By F. W. Taussig. 8vo.
- XIII. The Evolution of the English Corn Market from the Twelfth to the Eighteenth Century. By N. S. B. Gras. 8vo.
- XIV. Social Adaptation: A Study in the Development of the Doctrine of Adaptation as a Theory of Social Progress. By L. M. Bristol. 8vo.
- XV. The Financial History of Boston, from May 1, 1822, to January 31, 1909. By C. P. Huse. 8vo.
- XVI. Essays in the Earlier History of American Corporations. By J. S. Davis. 8vo. 2 volumes.
- XVII. The State Tax Commission. By H. L. Lutz. 8vo.
- XVIII. The Early English Customs System. By N. S. B. Gras. 8vo.
- XIX. Trade and Navigation between Spain and the Indies in the time of the Hapsburgs. By C. H. Haring. 8vo.
- XX. The Italian Emigration of Our Times. By R. F. Foerster. 8vo.
- XXI. The Mesta: A Study in Spanish Economic History, 1273-1836. By Julius Klein. 8vo.
- XXII. Argentine International Trade under Inconvertible Paper Money: 1880-1900. By J. H. Williams. 8vo.
- XXIII. The Organization of the Boot and Shoe Industry in Massachusetts before 1875. By Blanche E. Hazard. 8vo.

HARVARD UNIVERSITY PRESS  
CAMBRIDGE, MASS., U. S. A.



HARVARD ECONOMIC STUDIES

PUBLISHED UNDER THE DIRECTION OF  
THE DEPARTMENT OF ECONOMICS

VOL. XIV



Digitized by the Internet Archive  
in 2007 with funding from  
Microsoft Corporation

7111

# SOCIAL ADAPTATION

A STUDY IN THE DEVELOPMENT OF THE  
DOCTRINE OF ADAPTATION AS A THEORY  
OF SOCIAL PROGRESS

BY

LUCIUS MOODY BRISTOL, Ph.D.

ASSISTANT PROFESSOR OF SOCIOLOGY IN  
WEST VIRGINIA UNIVERSITY

WITH A PREFACE BY

THOMAS NIXON CARVER

AWARDED THE DAVID A. WELLS PRIZE FOR  
THE YEAR 1914-15, AND PUBLISHED FROM  
THE INCOME OF THE DAVID A. WELLS FUND



~~185054.~~  
31.10.23.

CAMBRIDGE  
HARVARD UNIVERSITY PRESS

LONDON: HUMPHREY MILFORD  
OXFORD UNIVERSITY PRESS

1921

COPYRIGHT, 1915  
HARVARD UNIVERSITY PRESS

First Impression, January, 1916  
Second Impression, December, 1919  
Third Impression, July, 1921

HM  
106  
B75  
1921

185054

TO MY WIFE



# CONTENTS

PREFACE . . . . .	PAGE ix
-------------------	------------

## PART I

X INTRODUCTION . . . . .	3
--------------------------	---

### CHAPTER I

AUGUSTE COMTE. Comte's Positive Philosophy a Prolegomenon to Sociology . . . . .	12
--	----

### CHAPTER II

X HERBERT SPENCER. Cosmic Evolution . . . . .	29
---	----

### CHAPTER III

#### SOCIOLOGICAL METHODOLOGY:

L. A. J. Quêtelet. The Statistical Method . . . . .	43
Paul Von Lilienfeld. The Analogical Method. . . . .	47
Guillaume De Greef. Classification as a Method of Sociological Knowledge . . . . .	49

## PART II

### PASSIVE PHYSICAL AND PHYSIO-SOCIAL ADAPTATION

#### CHAPTER IV

##### BIOLOGICAL EVOLUTION:

Jean Baptiste de Lamarck. Use-Inheritance . . . . .	56
Charles Darwin. Natural Selection . . . . .	58
August Weismann. Continuity of the Germ-Plasm . . . . .	68
Hugo de Vries. Mutations. . . . .	70
Johann Gregor Mendel. Independent Unit Characters . . . . .	71

#### CHAPTER V

##### NEO-DARWINIAN SOCIOLOGISTS:

Friedrich Nietzsche. Evolution of the Super-Man . . . . .	80
Benjamin Kidd. Religion and Social Progress . . . . .	85
Galton and Pearson. National Eugenics. . . . .	92
Vacher de Lapouge. Societal Selections . . . . .	99

## CHAPTER VI

## THE ENVIRONMENTAL SCHOOL OF SOCIOLOGISTS:

Karl Marx. Economic Determinism . . . . .	103
Henry Thomas Buckle. Intellect and Environment . . . . .	105
Ratzel—Semple. Anthro-Geography . . . . .	111
William Z. Ripley. Race and Environment . . . . .	115

## PART III

## PASSIVE SPIRITUAL ADAPTATION

## CHAPTER VII

## DEVELOPMENT OF THE CONCEPT OF SOCIETY AS AN ORGANISM:

Albert Schäffle. The Social Organism . . . . .	123
J. S. Mackenzie. An Idealistic Interpretation of Social Progress . . . . .	128
Gustav Le Bon. The Psychology of Peoples . . . . .	133
Emile Durkheim. Social Realism . . . . .	138
Further Development of the Organic Concept . . . . .	145

## CHAPTER VIII

## THE ANTHROPOLOGICAL SOCIOLOGISTS:

— William G. Sumner. Folkways . . . . .	152
Franz Boas. Opportunity and Race Progress . . . . .	155
Westermarck, Hobhouse, Thomas . . . . .	159

## CHAPTER IX

## THE HISTORICAL SOCIOLOGISTS:

Ludwig Gumplowicz. Progress by Inter-Group Conflict . . . . .	162
Gustav Ratzenhofer. Interests . . . . .	170
Walter Bagehot. Discussion and Animated Moderation . . . . .	177

## CHAPTER X

## SOCIOLOGISTS EMPHASIZING ONE ALL-IMPORTANT FORMULA OR PRINCIPLE:

Adam Smith. Fellow-Feeling <i>v.</i> Self-Interest . . . . .	182
Gabriel Tarde. Imitation . . . . .	185
James Mark Baldwin. The Dialectic of Growth . . . . .	192
Henry Drummond. Struggle for the Life of Others . . . . .	199
Franklin H. Giddings. Consciousness of Kind . . . . .	201

## CHAPTER XI

## TRANSITION FROM PASSIVE TO ACTIVE ADAPTATION:

The Problem and Attempts at Solution . . . . .	208
The Sociological Significance of the Free-Will Controversy . . . . .	213
John Fiske. The Prolongation of Infancy . . . . .	214



## PART IV

## ACTIVE MATERIAL ADAPTATION

## CHAPTER XII

## INVENTION AND PRODUCTION:

Lester Frank Ward. Material as the Basis of Spiritual Achievement . . . . .	221
Simon N. Patten. Pain-Pleasure-Creative Economy . . . . .	236

## CHAPTER XIII

## INVENTION AND PRODUCTION (continued):

Thomas Nixon Carver. The Super-Group . . . . .	245
--	-----

## PART V

## ACTIVE SPIRITUAL ADAPTATION

## CHAPTER XIV

## ACTIVE SOCIAL ADAPTATION:

Jacques Novicow. Social Progress by Cultural Attraction and Expansion . . . . .	268
---	-----

## CHAPTER XV

## ACTIVE SOCIAL ADAPTATION (continued):

Thomas Carlyle. The Rôle of the Great Man . . . . .	283
William James. The Energies of Men . . . . .	286
Edward Alsworth Ross. The Psychology of Social Control. . . . .	291

## CHAPTER XVI

## IDEALIZATION AND RELIGION:

According to Comte . . . . .	299
According to Ross . . . . .	301
According to Baldwin . . . . .	304

## CHAPTER XVII

SUMMARY AND CONCLUSION . . . . .	313
BIBLIOGRAPHY . . . . .	333
INDEX . . . . .	343



## PREFACE

THE doctrine of biological evolution did not originate with Darwin or with any other modern scientist. It is as old as human speculation. Darwin's supreme contribution was his positive proof that the method of evolution was the method of natural selection, of trial and rejection, of extermination and survival. Since his day biological evolution has meant a definite process capable of being studied in detail, tested and verified. Before his time it was only a generalization, a guess as to how things might very well have been, without any definite proof that they were actually so.

The concept of social evolution has gone through, or is going through, a similar course of development. This concept also is as old as human speculation. It has generally been, however, only a vague speculation, a guess as to how things socially might conceivably have come about, a vague idea of an unfolding process. A little more definiteness has come into the theory by the attempt to trace the successive stages of evolution. A treatise on this subject, however, is rather a book of social genesis than a book on social evolution. Until some one is able to point out the factors and forces which bring about social evolution, to show the method and the process, it will not have become a scientific concept.

In fact, Comte's three stages of mental development are beautifully illustrated in the development of the concept of social evolution. The theological stage is represented by the doctrine of a divine providence moulding human history and leading mankind along by a preordained path. The metaphysical stage is represented by most current theories of social evolution which only point out that society, like a biological organism, grows, and that its growth presumably is the result of some impersonal force or principle, rather than the personal interference of a supernatural being.

The world was prepared to believe much more easily in Darwin's theory of biological evolution than it is today prepared to believe in a similarly definite doctrine of social evolution. It is true that Darwin's theory ran counter to certain traditional theological beliefs of that day. The real concept of social evolution will run counter to much deeper currents of belief and tradition that still persist in the world in this twentieth century. It will necessitate a complete reorganization of our theories of morals, and of most of the ideals of the cultured classes. When it is stated, for example, by a great biological evolutionist, that nature is non-moral, or that one is not able to discern a moral order of the universe, the issue is pretty squarely drawn and the fundamental conflict of ideas is very clearly presented. It literally means that the person who makes such a remark is not yet prepared to apply the *method* of evolution to morals, social ideals and religious concepts.

The method of evolution is not simply a recognition that things go through certain processes of development. Many people imagine themselves to be moral evolutionists when they admit that moral ideals change and develop. They are not real evolutionists until they are willing to recognize that the processes of natural selection, of trial and rejection, of extermination and survival apply to moral principles and social ideals as well as to biological forms. To say that nature is non-moral is merely to say that one is not able to see that nature recognizes what one has been taught to believe to be moral. To say that one cannot discern a moral order of the universe, is merely to say that one cannot perceive that the order of the universe harmonizes with what one has believed to be moral. Until one is prepared to face about and say that nature is moral and that if it does not harmonize with what we have previously believed to be moral, that is a demonstration that our ideas of morality have been wrong, or that if he cannot discern a harmony between the order of the universe and his system of morals, that is a demonstration that his system of morals is wrong, he is not a true evolutionist. In other words, one must admit that whatever the order of the universe is, that is the moral order. This will prepare him for

the application of natural selection to moral codes and social ideals. That moral code which works best, which fits the people who follow it to survive by making them strong and efficient is per se the best moral code. Whether we like it or not, such people will rule the earth and crowd out of existence other people who follow different codes which make for less efficiency. As the present writer has said elsewhere, one might as well say that he is unable to perceive a hygienic order of the universe merely because what he has believed to be hygienic practice does not secure him good health, or that he does not discover a harmony between the order of the universe and his supposedly hygienic practices. If morality is social hygiene, then we must apply the same test to our moral practices and beliefs that we are compelled to apply to our hygienic practices and beliefs. If our hygienic beliefs do not seem to work in matters of health, we will, if we are wise, change our beliefs, rather than try to change the universe. Similarly, if our moral practices and beliefs do not seem to work, we must change our moral practices and beliefs rather than try to change the universe.

It will require a much greater mental revolution to adjust ourselves to this new doctrine of social evolution than it ever took to adjust ourselves to a biological doctrine of evolution. The beliefs that were involved then were only traditional beliefs regarding the Creation. These beliefs were never very deep-seated, and a single generation was sufficient to bring about the discarding of the old and the adoption of the new; but our fundamental notions of right and wrong are very much older than the Biblical story of the Creation, and very much more deep-seated. To have to give up, for example, a cherished belief regarding democracy, or socialism, or individualism, or culture, or gentlemanly conduct, or as to what constitutes virtue, in order to square ourselves with the facts of the universe, will involve such a mental struggle that very few can be expected to come through it very successfully in any single generation. Nevertheless, the process is going on. They will rule the world who are best fitted to rule the world by virtue of their strength and efficiency, not by virtue of the assumed beauty or persuasive power of

their ideals. They who are unfitted will perish as certainly as did the dinosaur or the mastodon, regardless of their apparent bigness or assumed attractiveness. It will be well with any people which undergoes this mental revolution early, and begins first to study how it may adjust itself, its moral practices, its social ideals, to the hard conditions of universal law. To do so is to prove itself to be the superior race or chosen people. To refuse to do so is to elect extermination rather than survival, death rather than life.

Dr. Bristol has done a notable service in tracing the development of this concept of social evolution or progress. From the formidable list of authorities quoted, and the volume of his quotations and citations, it is apparent that this topic has received large attention from students of social life. This laborious compilation together with Dr. Bristol's keen analysis and criticism will go far toward making clear a subject which has hitherto been obscure.

T. N. CARVER.

PART I

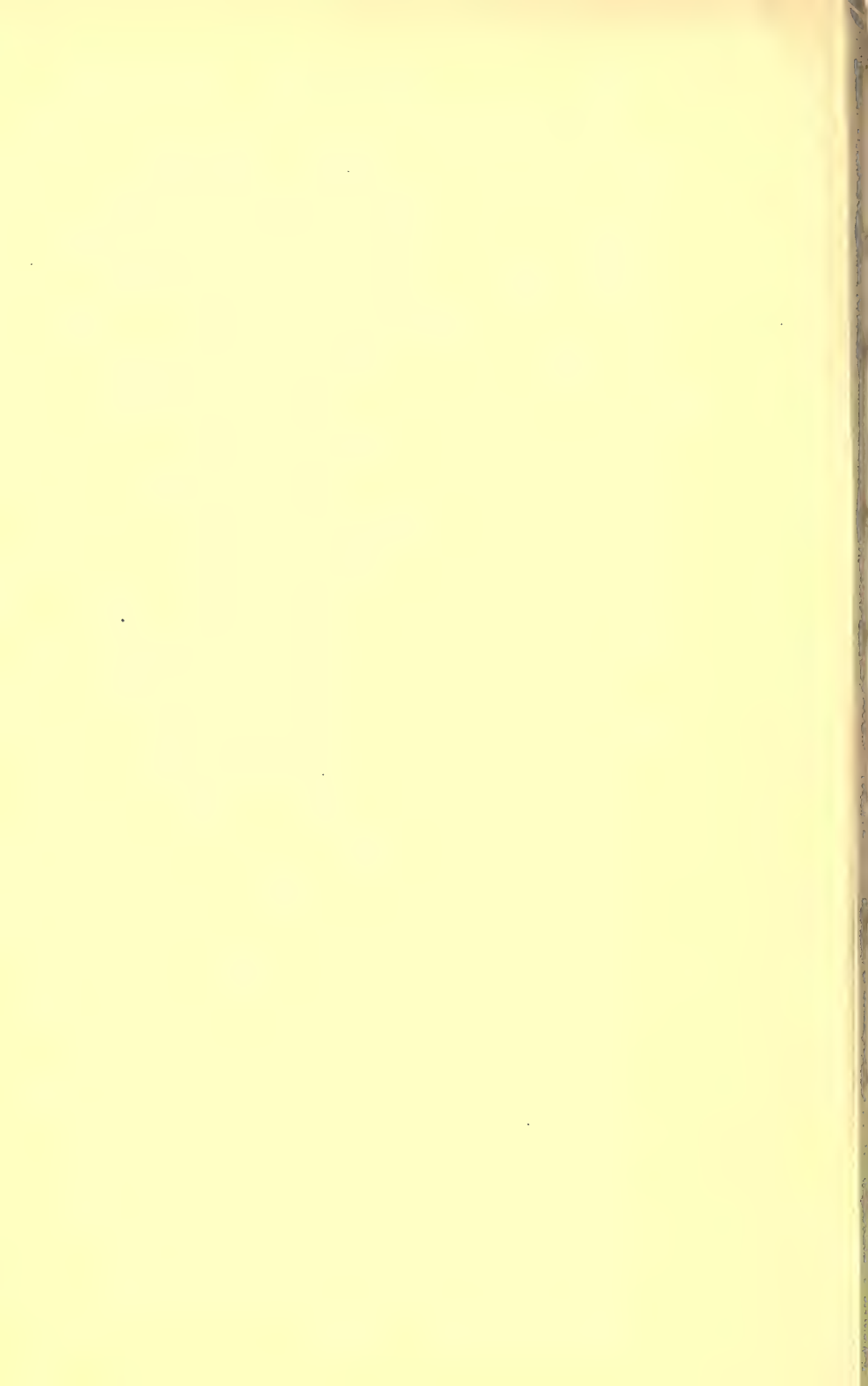



## INTRODUCTION

*The Meaning of Progress.* — Progress is a word frequently used though not always with critical precision. The nineteenth century was an era of marvelous increase in the production of wealth, in the acquirement of knowledge intensively and extensively, in methods of social reform and in agencies for the betterment of unfortunate man. But is this the essence of social progress? Ask the meditative Brahman or the static celestial! Is movement always forward movement? Is mere increase a sign of prosperity? Dr. Watkinson<sup>1</sup> speaks aptly of the fallacy of bigness. The boulder is vastly bigger than the diamond. Enlargement of the human body is often a sign of disease. Many feel that Carlyle did well to inveigh against the gospel of Mammonism and ridicule the theory of the leisure class of his day; that John Ruskin's prophetic voice rang true when he summoned economists to a different evaluation of wealth than that of mere interchangeable goods.

Increase of knowledge is not always advantageous either to the individual or to society. Walter Bagehot in praising the virtues of stupidity says that nations, just as individuals, may be too clever to be practical and not dull enough to be free. "Knowledge puffeth up," — sometimes to a man's eternal damnation. A strong prejudice against college education for the young man of only average ability prevails among a certain class of men of affairs and it is true that there are many whose superior education has unfitted them, apparently, to adapt themselves to life conditions. Nor do all agree that it is a sure sign of progress that our enlarged sympathy has built almshouses, asylums and orphanages to prolong the lives of the weak and unfortunate and apparently thwart nature's plan of eliminating the unfit in the struggle for existence.

<sup>1</sup> The great Wesleyan preacher in his book *The Education of the Heart*.

“Each of us,” says Ross, “considers a change progressive when it advances society toward his ideal. But one man’s ideal is freedom, while another’s is order; one man borrows from biology the criterion of differentiation, while another imports from psychology the idea of harmony; one man’s touchstone is the happiness of the many, while another’s is the perfecting of the superior few. It is, therefore, hopeless as yet to look for a test of progress that shall be objective and valid for all. Since change is a matter of observation, whereas progress is a matter of judgment involving the application of a subjective standard, those who desire to see sociology a true science are justified in insisting that social dynamics deal with the factors and manner, not of social progress merely, but of social change.”<sup>1</sup> This is very true for sociology as a science which deals with facts and laws, but sociology is also a philosophy which evaluates. Social science observes and systematizes social phenomena and their relations; but social philosophy seeks to understand these phenomena not merely in their relations of co-existence and sequence but as a system, — a causal order.

It is nearly a hundred years since Auguste Comte gave the world his *Positive Philosophy* as a theory of social progress, first as lectures, later in published form. Since then many have followed in his footsteps and many more, without pretending to think social phenomena as a whole, have contributed to social science by the discovery and formulation of social laws.

In the history of social science and social philosophy, if I observe correctly, one word, or the principle of which it is the symbol, stands out with ever increasing prominence, — that of *adaptation*. It is the main purpose of this book to trace the development of this doctrine as a theory of social progress.

*The Value of Social Philosophy.* — Our discussion will lead us to consider such questions concerning the social group, large and small, as have ever perplexed thoughtful souls concerning their own existence, *whence, how, whither, and why?*<sup>2</sup> But as consideration of such ultimate questions is tabooed by so many in

<sup>1</sup> *Foundations of Sociology*, p. 186.

<sup>2</sup> Cf. Ward, *Applied Sociology*, p. 3.

this hyper-utilitarian age and nation, such an investigation may call for justification.

One such justification has been mentioned in that we persist in using the term progress despite the fact that we are warned that it has no common meaning. We hear the query raised from time to time as to whether the world is growing better or worse. We Americans are proverbially boastful of our superiority as a nation, and concerning the progress we have made since the venture of '76. But all such queries and all such boasting is vain unless we have a common standard.<sup>1</sup>

Such a study, then, should aid in clear and consistent thinking and that is always desirable. To think logically on this subject, may, perchance, help us to clear thinking concerning matters pertaining to bread and butter.

Again, this is an age of social Utopias and of all sorts of schemes looking toward social amelioration. Every state legislature is trying to usher in the millennium by force of statutes, for the most part making sorry work of its task. The yellow press and maroon magazine as well as high-grade periodicals fill columns with plans for social reconstruction. Writers in educational journals as well as in the penny press are criticizing our present educational system and trying to formulate a "get-culture-quick" device to correspond to the "get-rich-quick" schemes that have been so fruitful, — to their promoters, — during the past quarter century.

The one supreme need of this hour is sanity and scientifically worked out policies of social amelioration, and one requisite is an attempt to "see life steadily and see it whole," to climb some height from whose summit the complexities and confusions and contradictions of life may, perchance, seem to form one co-ordinate whole, in which disharmonies enter into the production of a higher harmony. If the view does not thus yield harmony, it does at least yield perspective and a degree of unity not possible in the view that we get from a study of mere details. Such an outlook on life should yield an inner consistency, purpose and power not to be obtained by partial views. It may be, indeed,

<sup>1</sup> Cf. Fiske, *Cosmic Evolution*, ii, pp. 193 ff.

that our philosophy will be pessimistic, but even so it will enter the lists to contend with those of different cast, and the attainment of truth, if this is a rational universe, must be the ultimate outcome, and with truth, increased well-being. A second justification for such an investigation is thus to provide a critique of current social theories and of schemes for social regeneration.

Social philosophy has a third function. Advance in science is dependent very largely on the possession of a scientific imagination, — the power to jump at conclusions which become working hypotheses to be verified, repudiated or corrected in the light of inductive study. The western world is interested today as never before in the increase of human well-being. But social amelioration is as truly a science as physics or geology though infinitely more complex. Sane advance in this science must be guided by sane philosophy. The latter will furnish the background for the formulation of laws and methods of social advance and these should prove far more workable than unsophisticated guesses.

Spencer in his *Study of Sociology* says that if you give a man who does not understand metal work a sheet of metal with a dint in it and ask him to flatten it out, he will take a hammer and knock the dint flat only to find that it has appeared elsewhere. He tries to flatten these other dints but with like result.<sup>1</sup> Thus it is with much social legislation not based on the laws of social change.

A final justification is analogous to Comte's praise of the crude beliefs of primitive times. As those common beliefs in spirits that animated and controlled the phenomena of nature provided a unity of thought as the necessary background for unity of action, so a generally accepted theory of social progress would provide an educational aim that could be put into practice; a common principle of legislation that would make enforcement easy; a common goal of endeavor which might make possible a social reconstruction in the interest both of the group as a whole and of the constituent members.

Comte claimed this virtue for his system but the vagaries of his *Polity* did much to retard the spread of his theory. Since

<sup>1</sup> Quoted by Hobhouse, *Social Evolution and Political Theory*, p. 5.

his day great advance has been made and the leaders of thought and life in the western world are coming to agreement as never before on fundamental principles of life and progress.

During the last quarter of the nineteenth century evolution was the open sesame to the interpretation of all phases of life, but this term has proven too vague. More and more that general concept is being analyzed, narrowed, defined. Its place, as we shall see, is being usurped by the more definite concept of adaptation, which has already obtained a foremost place in educational philosophy, even in that narrower and more conservative sphere of education which is concerned primarily with the religious phase of life, and is invading, too, the domain of political science. A second purpose of this thesis, then, will be to indicate the utility of this concept of *adaptation* in interpreting various phases of social endeavor.

*Method.*—Our subject naturally calls for an analysis of systems of social philosophy with the one special aim of showing the contribution of each to this doctrine of adaptation. It will be in our province, also, to investigate the writings of others outside the sphere of sociology proper who have contributed to the development of this doctrine. We shall not attempt, however, to trace this development back in its several root forms to early ages. Such a task would be too great and of too little value. Indeed this field has been cultivated already to a considerable extent. Professor Osborn has traced the development of the doctrine of adaptation as a theory of biological evolution back to the early Greek physicists, especially to Empedocles,<sup>1</sup> and Professor Flint's *Philosophy of History* contains abundant material for the study of the use of this concept among early social philosophers. Modern sociology is generally conceded to take its rise from Auguste Comte, so our investigation may well begin with him, although reference will be made to some who lived in an earlier age.

Several methods of procedure are open to us. The subject suggests a historical method, but inasmuch as the period covered is less than a century such a method presents many difficulties.

<sup>1</sup> *From the Greeks to Darwin.*

Two other methods are suggested in Professor Carver's *Sociology and Social Progress*. In the Introduction he analyzes adaptation as passive and active material and passive and active social. We might, then, trace the development of each form of adaptation from Comte to the present. The difficulty here is that several authors have made contributions bearing on each of these four divisions, and such a method would make impossible the study of the social theory of an author as a whole. A third method might follow the outline in the book referred to, and discuss the development of the doctrine from the side of biology, economics, psychology and the social sciences including religion. But our chief interest is to study social theories rather than the writings of economists and social scientists except as they bear directly on the subject in hand, and here, again, as in the previous case, some authors have contributed along several different lines.

It seems best, therefore, to discuss the social theories of the writers who have been most influential in the development of this doctrine of adaptation or whose contributions are most important in a constructive social philosophy built around this concept, and in an order which shall be, so far as possible, both historical and logical. In the treatment of some writers attention will be given only to their specific contribution to our subject while in the case of others a brief outline of their general social philosophy will be necessary as a background for a due appreciation of that contribution. The work as a whole will thus furnish an approach to a constructive social philosophy by a review of the systems of many writers not only in English but also in German and French.

*Definition of Terms.*—Adaptation may be considered as a state or as a process.<sup>1</sup> By the former is meant such relationship between an organism, species, social group or institution as is favorable to existence and growth; by the latter is meant the process by which such a unity becomes and continues in favorable relation to its environment. There are two general classes of environment, physical or material, and spiritual, including social, and two general classes of adaptation, passive and active. By

<sup>1</sup> Cf. Haeckel, *The Last Link*, pp. 84, 117 f.

passive adaptation as a process is meant the non-purposeful modification of an organism, species, social group or institution to suit it to its environment. If we differentiate the process further, as above, passive physical adaptation will comprise the process of biological evolution including permanent somatic differences in ethnic groups whereas passive spiritual adaptation will comprise the evolution of all psychic factors in the individual and race, and the expression of these in language, mores, laws and social institutions (so far as the process is non-purposeful). It thus comprises nearly the whole process of education, including moral and religious, and much of social control. By active adaptation is meant the purposeful modification of any organic or quasi-organic unity to suit it to its environment or the purposeful modification of the environment to make it favorable to the unity. If we differentiate further, active material adaptation will include the process of industrial development while active spiritual adaptation will comprise the purposeful adjustment of the individual to his spiritual environment, social, ideal and transcendental, the work of true teachers and social reformers and purposeful social control.

Of course there are no hard and fast lines between these divisions, but the above classification will prove useful in the general discussion of the subject and may be represented by the following scheme: —

MODE OF ADAPTATION	KIND OF ENVIRONMENT	
	Physical or Material	Spiritual (including Social)
Passive	Biological evolution including relatively permanent differences in somatic characteristics of individuals in different races, and development of brain and nervous system including instincts.	Evolution of psychic and social factors and of their expression in language, mores, laws and other social institutions. Process of education (including moral and religious). Genetic social control.
Active	Industrial development.	Telic adjustment of the individual to his spiritual (including social) environment. Work of true teachers and moral reformers. Telic social control.

The complexity of the task of social philosophy and of the social problems to be solved by the theory of adaptation is illustrated by the following diagram:—

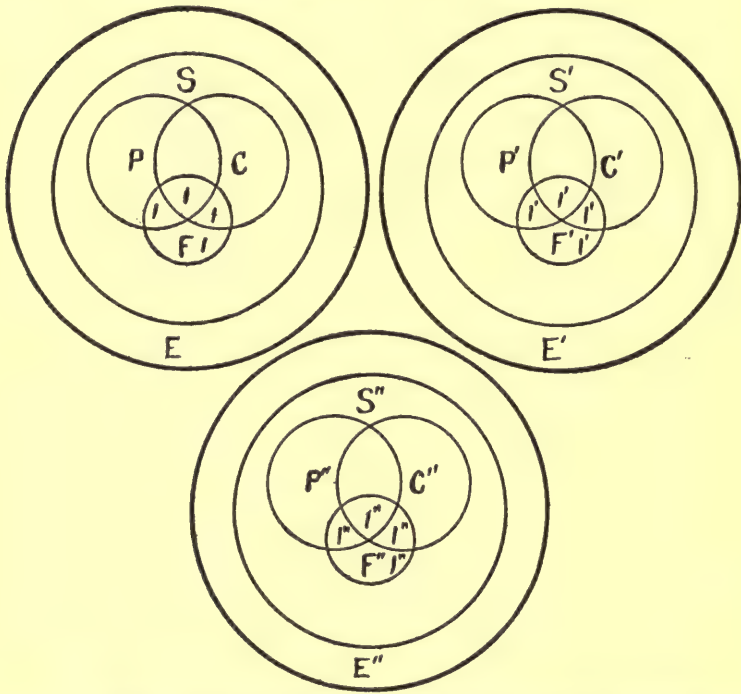

Let  $S$ ,  $S'$ , and  $S''$  represent three social groups in three different environments,  $E$ ,  $E'$ , and  $E''$  respectively. Let  $P$ ,  $P'$ , and  $P''$ , represent political parties,  $C$ ,  $C'$  and  $C''$  church organizations and  $F$ ,  $F'$  and  $F''$  family groups, the individuals in each case being represented by  $I$ ,  $I'$  and  $I''$ . Sociology has as its scope to describe and if possible explain the following: (1) the physical and psychological differences that characterize the individuals of the three groups as determined by use of the normal frequency curve; (2) the socio-psychical differences between the groups considered as unities; (3) the reciprocal relations between each group and its physical environment, i. e., between  $S$  and  $E$ ,  $S'$  and  $E'$ ,  $S''$  and  $E''$ ; (4) the reciprocal relations between each group and its constituent social organizations, i. e., between  $S$  and  $P$ ,  $C$  and  $F$ ,  $S'$  and  $P'$ ,  $C'$  and  $F'$  and  $S''$  and  $P''$ ,  $C''$  and  $F''$ ; (5) the reciprocal relations between each group and its constituent members, i. e., between  $S$  and  $I$ ,  $S'$  and  $I'$ ,  $S''$  and  $I''$ ; (6) the reciprocal relations between the organizations in each society, i. e., between  $P$  and  $C$ ,  $C$  and  $F$ ,  $P$  and  $F$ , etc.; (7) the reciprocal relations between each organization and its constituent members, i. e., between  $P$  and  $I$ ,  $C$  and  $I$ , and  $F$  and  $I$ , etc. But each group has its super-organic environment, that is,  $S$  is in relation with  $S'$  and  $S''$ , etc. This complicates the problem further as follows: Each social organization is in reciprocal relations with similar organizations in each of the other groups, each individual in one group is subject to influences from any individual in another group, and, indeed, one group as a unit may conceivably be modified by an individual from another group. This complication, however, is even less important than one arising from the fact that the intra-group organizations overlap, as indicated by the intersecting circles, so an individual may belong to two or more organizations. At times there is conflict of interests between the individual and the organization to which he belongs or between the organizations as unities.

Social philosophy as before suggested has as its task to see the whole social process as a unity, if possible, and out of the chaos of



these inter-relations and conflict of interests find an underlying harmony. It must not only interpret the past, but in the light of this forecast the future, and if possible point the way of larger life to every thinking individual and purposeful group, — the way of more complete adaptation both passive and active.

The purpose of this book is thus to show how the doctrine of adaptation is coming more and more to be considered as the key to social philosophy and its manifold problems, and how this doctrine has evolved until at present it is being applied to the process by which man and social groups, by taking thought, transform their material and spiritual environment, and to the process by which they become conformed into more or less agreement with their ideals and with the **WORLD ALL** or **GOD**.

## CHAPTER I

AUGUSTE COMTE (1798-1857)

### COMTE'S POSITIVE PHILOSOPHY A PROLEGOMENON TO SOCIOLOGY<sup>1</sup>

Short as is our life, and feeble as is our reason we cannot emancipate ourselves from the influence of our environment. Even the wildest dreamers reflect in their dreams the contemporary social state. — *Positive Philosophy*, ii, p. 11.

AUGUSTE COMTE in his life and philosophy is a striking confirmation of the doctrine of relativity expressed in the above quotation, — a doctrine which forms such an important part of his teaching and one which is closely related to the doctrine of adaptation. His relation to his age, to his race, to his generation, to his local environment may be discerned with a good deal of clearness, and hereditary traits and the experiences of his personal life are reflected in his system of philosophy and in the theory of social reconstruction elaborated in his *Polity*.<sup>2</sup>

<sup>1</sup> Owing to the controversy among the students of Comte as to the unity of his writings, our analysis will be confined almost entirely to the *Cours* with quotations from the well-known English summary by Miss Martineau. The *Cours* was the making of Comte's reputation and on it is based almost exclusively his influence on sociology. His romantic love experience with Clotilda de Vaux had a profound effect on his life and thought, and ever after that the "heart" was given a place of pre-eminence over the intellect. The *Polity* adds little else essential to social philosophy except the exposition of idealism and religion which we will discuss in a later chapter. See Flint, *Philosophy of History*, pp. 259 f.

For the influence of Clotilda de Vaux see *Système*, Preface; also *A General View* (Bridges), pp. 242 f.

<sup>2</sup> "Comte was the son of a revolutionary epoch, — a time full of jarring oppositions, full of unsolved problems. For this reason, he who attempts at any time to penetrate deeper into the peculiarity of his doctrines and of his personality that he may make real to himself the things which the great world taught Comte to know in later life, should never forget under what conditions and under the influence of what teachers the youth grew to manhood. He must know the pictures that met his gaze, the words that filled his ears, the problems that pressed ceaselessly upon his mind." Waentig, *A. Comte und seine Bedeutung für die Entwicklung der Sozialwissenschaft*, p. 43; cf., however, *ibid.*, p. 207, where Waentig claims that Comte's philosophy was essentially "unfrench."

A Frenchman of the south, warm-blooded, impulsive, sentimental yet withal practical; drilled in early youth under the educational ideal of his day with special emphasis on mathematics and logic; taught to seek in all things system and unity; breathing from earliest years the spirit of revolt from all external authority; so influenced by his social environment and especially by one master that his rebellious nature found expression at fourteen years of age by turning from the catholic-royalistic principles of his parents to become a free-thinking republican; steeping his young precocious mind in the French philosophical writings of the eighteenth century which were grossly materialistic, together with the writings of Hume and the English economists; conscious of the failure of Rousseau and his followers to regenerate society, and of the failure, too, of the retrogressive theory of de Maistre and the sentimental schemes of Owen, LeBlanc, Fourier and Saint-Simon, Comte saw at last the possibilities of the scientific method applied to social phenomena and wrought out that system of social philosophy which in broad outline stands as the foundation of the prevailing theories of social progress today.<sup>1</sup>

It has been said that all the elements in the *Positive Philosophy* may be found in earlier systems.<sup>2</sup> Comte devotes one whole chapter to a review and criticism of the methods and conclusions of some of his most illustrious predecessors in the field of social philosophy including Aristotle, Montesquieu, Condorcet and Adam Smith whom he praises as an exception to the economists for whom otherwise he has little use.<sup>3</sup> He omits all mention of Saint-Simon, however, doubtless owing to his pique against the one whom he recognized as master till their break in 1834, although he was indebted to Saint-Simon more than to any one else not only for his enthusiasm for social regeneration but also for some of the most important principles of his *Positive Philosophy*.<sup>4</sup>

<sup>1</sup> Cf. Lévy-Brühl, *History of Modern Philosophy in France*, pp. 394-396. Waentig, *op. cit.*, pp. 221 ff., 387 ff. Mill, *Auguste Comte and Positivism*, p. 52.

<sup>2</sup> For catalogue of sources of Comte's philosophy, see Defourney, *La Sociologie Positive*, pp. 352 ff.

<sup>3</sup> *Positive Philosophy*, ii, pp. 61 f.

<sup>4</sup> For an able discussion of the controversy as to the dependence of Comte on

Comte was not so much an original thinker as a system builder, but so well did he do his task that social philosophy since his day has done little more than to fill in his outline and correct and supplement his method. Thus the *Positive Philosophy* may not inaptly be termed a prolegomenon to sociology, and the more so as the conscious aim of his work was introductory rather than exhaustive or even technically scientific.<sup>1</sup>

A brief survey of his social philosophy is necessary for an appreciation of his place as the founder of the new science and of his contribution to the doctrine of adaptation as a theory of social progress.

Of first importance is Comte's emphasis on the necessity of a social philosophy as the basis of social reorganization.<sup>2</sup> This was the natural outcome of the reaction of such a character on such an age. It was a period, as he well observed, of intellectual, moral and social anarchy,<sup>3</sup> and he felt that these were vitally related and that for social adjustment and moral vigor there must be

Saint-Simon, see Barth, *Philosophie der Geschichte als Sociologie*, pp. 56, 57. He mentions the following contributions of Saint-Simon to social philosophy, most of which were made use of by Comte: (1) Politics is a positive science, i. e., a science depending on observations as positive as those of physics. (2) The total condition of society and not merely the constitution of the state is its object. (3) The process of the development of the human mind follows a fixed direction parallel with the philosophy of life, — from theology through metaphysics more and more to positive science, and in practical life from militarism to industrialism. [Though this thought is found in Turgot, Whittaker, *Comte and Mill*, p. 14, claims it was an independent discovery on the part of Comte.] (4) Each philosophical system is bound up with a political system which is grounded upon it, at every stage of the process of this spiritual development. But besides this every political system rests also on a certain arrangement (*Ordnung*) of property rights and method of production which results in a definite class formation. (5) He gives for the first time a sketch of the history of this class formation in which he confines himself to France with side glances to England. (6) He desires thus to raise history from literature to science. "Almost every one of these items," says Barth, "became a suggestion to new thoughts and investigations for Saint-Simon's scholar, A. Comte, who endeavored to build up the science proposed by Saint-Simon, and to carry out to complete unity what flitted before the mind of the other in merest outline." The last part of (4) and (5) which were fundamental with Saint-Simon were almost ignored by Comte. Cf. also, Ferras, *Étude sur la Philosophie*, pp. 313 ff.

<sup>1</sup> *Positive Philosophy*, i, ch. II.

<sup>2</sup> *Ibid.*, i, pp. 14, 16; ii, pp. 31, 41 ff., 165, 489-522. *A General View*, ch. II.

<sup>3</sup> *Positive Philosophy*, ii, pp. 9, 30, 31.

unity of thought and conviction. His philosophical training made acceptable the suggestion of a scientific interpretation of social phenomena such as had already been attempted by Montesquieu, Condorcet and Saint-Simon. It remained for him to work out a complete system in outline which he felt sure would be so convincing as to win speedy and wide-spread acceptance and make social regeneration possible.<sup>1</sup> The fact that the scientific method had reached the domain of social phenomena was proof to him that it offered the only possible workable basis for practical politics.<sup>2</sup> He could not but admire the organization of the Roman Catholic church and the power it possessed<sup>3</sup> but he could not agree with de Maistre that it had potency for social reform because it stood for a theological interpretation of life, i. e., a belief in personality as the mainspring of action rather than natural laws. He could not agree any better, however, with the social philosophers of his day who following Rousseau believed in a "return to nature" which seemed to him a denial of social evolution. The metaphysicians had performed their task by destroying the faith of the people in the teachings of theology, but with this had come a destruction of moral authority and a decay in personal and social life which Comte would bring back. "The object of all my labor," he wrote in 1825, "has been to re-establish in society something spiritual that is capable of counterbalancing the influence of the ignoble materialism in which we are at present submerged."<sup>4</sup> Catholicism stood for order but was incapable of inspiring progress. The destruction of Catholicism seemed necessary for progress but such a movement had led to anarchy. Comte's task was to synthesize order and progress and thus destroy the condition of anarchy in morals and politics which reigned in his day, and his method was by an appeal to science.

Comte's belief that the intellect always and of necessity led in social progress was further reason for his emphasis on the need of a thorough-going social philosophy as the basis for social recon-

<sup>1</sup> By the time he wrote the *Polity* he had experienced disappointment.

<sup>2</sup> *Positive Philosophy*, ii, p. 14.

<sup>3</sup> *Ibid.*, ii, pp. 261 ff.; Lévy-Brühl, *op. cit.*, p. 363.

<sup>4</sup> Lévy-Brühl, *op. cit.*, p. 361.

struction.<sup>1</sup> In his earlier investigations he seems to have sought a principle of unity in social phenomena as all-comprehensive as the law of gravitation in physics<sup>2</sup> but he failed and later repudiated the idea insisting only on unity of thought,<sup>3</sup> unity of feeling,<sup>4</sup> unity of purpose<sup>5</sup> and unity of method.<sup>6</sup>

Comte's philosophy of history of which he makes large use as a support to his social philosophy is based primarily on the law of the three stages,<sup>7</sup> but in a lesser degree on the phenomenalism of Hume and some of the French materialists, on Pascal's fiction of all humanity from earliest times to the present conceived as a living, learning personality,<sup>8</sup> on Condorcet's device of considering all nations and peoples as forming one society,<sup>9</sup> and on Hobbes' conception of humanity as a gigantic organism.<sup>10</sup> It is thus largely deductive, logical and abstract rather than inductive and scientific, although Comte advocates the scientific methods of observation, experiment and comparison supplemented by the historic, with the expression of hope of large future contributions from biology.<sup>11</sup> He combines the deductive and inductive methods most ingeniously yet not in a way to satisfy the demands of science today. Indeed he is accused by Barth of distorting facts to fit his theory.<sup>12</sup>

The law of the three stages, suggested by Turgot and Saint-Simon, becomes fundamental with Comte. He makes use of it to prove that the time is ripe for a reorganization of society based on science; that this science of social phenomena which he calls

<sup>1</sup> *Positive Philosophy*, i, ch. I; ii, pp. 51, 157 f., 495-497. Barth, *op. cit.*, p. 26; *A General View*, pp. 23, 79 f.; cf., however, his emphasis on "heart" and "love" in his *Polity*.

<sup>2</sup> *Positive Philosophy*, i, pp. 3, 16; cf. Lévy-Brühl, *op. cit.*, pp. 378, 379.

<sup>3</sup> *Positive Philosophy*, ii, pp. 504, 511, 521. <sup>4</sup> *A General View*, p. 13.

<sup>5</sup> *Positive Philosophy*, ii, pp. 498, 521; *A General View*, p. 26.

<sup>6</sup> *Positive Philosophy*, i, p. 17.

<sup>7</sup> *Ibid.*, i, ch. I; ii, pp. 158 ff. Cf. Flint, *op. cit.*, i, pp. 267 f.

<sup>8</sup> *Positive Philosophy*, ii, pp. 54, 95; *A General View*, p. 372. This figure was used by Perrault, Fontenelle, Abbé de St. Pierre, as well as by Saint-Simon and Littré-Flint, *History of the Philosophy of History*, pp. 213 f.

<sup>9</sup> *Positive Philosophy*, ii, pp. 58, 83.

<sup>10</sup> *Ibid.*, ii, p. 509.

<sup>11</sup> *Ibid.*, ii, pp. 96 ff.

<sup>12</sup> Barth, *op. cit.*, p. 26; cf. Mill, *op. cit.*, p. 60; Mackintosh, *From Comte to Benjamin Kidd*, p. 41.

social physics or sociology, forms the climax of all the sciences which he arranges in a hierarchy based on filiation,<sup>1</sup> increasing complexity,<sup>2</sup> decreasing perfection in the sense of quantitative exactitude,<sup>3</sup> and on the order of development of the sciences to that condition which might be termed positive. This classification, repudiated by Spencer, has been adopted with some modifications and explanations by Mill, Ward,<sup>4</sup> Giddings, De Greef and many others.

This law of the three stages was incorporated into Mill's logical doctrine as the "inverse deductive method."<sup>5</sup> It assumes that the general human mind has developed the same as the individual mind. Experience showed Comte that the child is imaginative with a personal-causal explanation of phenomena whereas the adult, at least the one schooled in the scientific method, interprets phenomena by reference to natural laws.<sup>6</sup> The period of youth had been with Comte a transition period, a period of storm and stress, of intellectual and moral anarchy and this he saw was characteristic of youth. Comte found stages of civilization that corresponded to these periods; primitive societies imaginative with a personal explanation of phenomena, the five nations of western Europe in the centuries just preceding his time corresponding to the anarchic stage of youth, and the era dawning with its emphasis on law like unto the mature mind of cultured man.<sup>7</sup> He shows also that each science in its development has passed through these stages.

One other item is worthy of consideration before passing to the discussion of his specific social doctrines, — his conception of law. In this he seems to have followed Hume. Not only does he repudiate the effort to discover the final cause of change, but it would seem that he fails to recognize, also, efficient cause in the system itself. He seeks only laws of similitude and succession among phenomena.<sup>8</sup> The former make possible his scheme of logical

<sup>1</sup> *Positive Philosophy*, i, p. 28; cf. Ward, *Pure Sociology*, ch. V.

<sup>2</sup> *Positive Philosophy*, i, ch. II.

<sup>4</sup> *Pure Sociology*, pp. 65 f.

<sup>3</sup> *Ibid.*, i, pp. 29, 223.

<sup>5</sup> Whittaker, *Comte and Mill*, p. 23.

<sup>6</sup> *Positive Philosophy*, i, p. 3.

<sup>7</sup> *Ibid.*, ii, chs. VII–XI. Lévy-Brühl, *op. cit.*, p. 364.

<sup>8</sup> *Positive Philosophy*, i, pp. 5, 12, 217, 221, 225 f., 515.

classification and the latter forms the basis of his "explanations"; but, as Mill has justly remarked, "There are two kinds of uniformities, the one conditional [as the succession of day and night], the other conditional on the first [as the dependence of this succession on the revolution of the earth]; laws of causation, and other successions dependent on those laws."<sup>1</sup>

Comte repudiates all hypotheses not capable of verification such as those of luminiferous ether and chemical affinities as being metaphysical,<sup>2</sup> yet he does not always keep clear of such assumptions, as when he assumes a "tendency to development" in man,<sup>3</sup> and when he admits that his biological classification is purely subjective, i. e., is logical rather than genetic. This last point is of such importance as to warrant the giving of a few quotations in its support. In discussing biological evolution he justifies the use of scientific fictions to fill up the gaps in the evolutionary process. "The process," he says, "would be to intercalate among different known organisms, certain purely fictitious organisms, so imagined as to facilitate their comparison, by rendering the biological series more homogeneous and continuous: and it might be that several might hereafter meet with more or less of a realization among organisms hitherto unexplored."<sup>4</sup> "In forming the animal series, it (our encyclopedia) — [i. e., of positivism] — takes as its continual guide the true object of that formation, — a logical rather than a scientific object. As we only study the animals to gain a sounder knowledge of man by tracing through them his connections with plants, we are fully authorized to exclude from our hierarchy all the species which disturb it." He goes on to show that the same method is justifiable in social evolution; i. e., the creation of certain races and introduction of them into the logical series to make it complete.<sup>5</sup>

That his synthesis is consciously and purposely subjective and logical rather than objective is proven by these words: "Not merely is it true, that no organic existence ever sprung from

<sup>1</sup> Mill, *op. cit.*, p. 58.

<sup>3</sup> *Ibid.*, ii, pp. 83, 88. Cf. ii, p. 147.

<sup>2</sup> *Positive Philosophy*, i, pp. 225 f., 301.

<sup>4</sup> *Ibid.*, i, p. 389.

<sup>5</sup> *The Catechism of Positivism*, pp. 222, 224. Cf. *Positive Philosophy*, ii, pp. 520, 521; also *A General View*, pp. 34 f., 369.



inorganic nature; but further, no species of any kind can spring from a different kind, either inferior or superior. The limits of the exception to this rule are very narrow, and are as yet but little known. There is then a really impassible gulf between the worlds of life and of matter, and, even though less broad, between different forms of vitality. This view strengthens our position that any simply objective synthesis is impossible. But it in no way impairs the subjective synthesis, in every case the result of a very gradual ascent towards the type of man." This subjective synthesis, then, as we have noted above, is merely a logical classification according to a pre-determined plan, although based on scientific observation, and does not necessarily represent a historical order of development, much less a real causal order. Comte does not always hold to the above distinction, to be sure, and in places seems to hold that the subjective order represents the objective.<sup>1</sup>

Comte considers that society is an organism but further that it is the reality whereas the mere individual is an abstraction.<sup>2</sup> His doctrine of society is developed under the two-fold aspect of static and dynamic, the former corresponding to order, the latter to progress. By static he seems to mean a cross-section of social evolution showing the "consensus," "interconnections," "concurrency," "harmony," "co-operation" of the parts under the laws of co-existence.<sup>3</sup> By dynamic he means the same phenomena viewed as a process of development under the laws of antecedents and consequents. The one is a sort of social anatomy, the other a sort of social physiology.<sup>4</sup>

Comte's conception of all humanity as a developing organism is, as we have noted, a logical fiction, yet with sufficient basis in fact to form a suggestive working hypothesis. It corresponds to the figure used by Hildebrand,<sup>5</sup> of nations in relays carrying forward the torch of progress; but Comte seems to consider also

<sup>1</sup> *Positive Philosophy*, ii, pp. 520, 521. Cf. Barth, *op. cit.*, pp. 25-27.

<sup>2</sup> *Positive Philosophy*, i, p. 363; ii, pp. 508-509; *A General View*, p. 370. The general mind is regarded as prior to the individual mind, and the latter can be understood only by reference to the former.

<sup>3</sup> *Positive Philosophy*, ii, pp. 74-84.

<sup>4</sup> *Ibid.*, ii, pp. 84-89.

<sup>5</sup> *German Thought*, Lecture I.

that specific groups form "societies" characterized by a certain community of thought and life. This conception, developed by Spencer, Le Bon, Durkheim and others, approaches much more nearly to concrete reality.<sup>1</sup>

Comte's law of the three periods, together with his fiction of all humanity as a developing organism, is the basis of his doctrine of relativism which is, perhaps, his most important contribution to social philosophy.<sup>2</sup> By relativism he has in mind not only the relativity of knowledge emphasized by Spencer, but even more the relativity of social phenomena to the stage of development of the organism.<sup>3</sup> That is, there is no absolutely right form of government, or religion, or set of moral principles, — or at least not until developed by positivism.<sup>4</sup> A certain form is appropriate to society in the theological stage, another when it has reached the metaphysical and still another when all life is interpreted and organized in accordance with science.

The dynamic study of society gives rise to the problem of progress.<sup>5</sup> The one phrase used most by our author, especially in the *Polity* is *the development of order*,<sup>6</sup> though he also uses that of increasing differentiation and integration,<sup>7</sup> a growing preponderance of cultural over organic phases of life,<sup>8</sup> and an enlargement of man's powers over the forces of nature.<sup>9</sup> In particular, we have as proof of material progress the fact that though there has been great increase in population there has been, also, an increase in the satisfaction of wants.<sup>10</sup> Intellectual development is shown by an increase in the aptitude for mental combinations and abstract thinking.<sup>11</sup> Moral progress is marked by the development of the social faculties and by the expression of these in industrial co-operation and efforts toward social amelioration.<sup>12</sup>

<sup>1</sup> *Positive Philosophy*, ii, pp. 132, 491 ff.

<sup>2</sup> *Ibid.*, ii, pp. 77, 92 ff. Cf. Small, *General Sociology*, pp. 68 ff.

<sup>3</sup> *Positive Philosophy*, ii, pp. 517 f.

<sup>4</sup> *Ibid.*, ii, pp. 14-16. Cf. Mill, *op. cit.*, pp. 177 ff.

<sup>5</sup> *Positive Philosophy*, ii, pp. 84-89; Mill, p. 100; *A General View*, p. 117.

<sup>6</sup> *Ibid.*, p. 116. <sup>7</sup> *Positive Philosophy*, i, p. 120; ii, p. 140.

<sup>8</sup> *Ibid.*, ii, pp. 89, 129, 150 ff.

<sup>9</sup> *Ibid.*, i, p. 361; ii, pp. 88, 118 f., 129, 150, 259.

<sup>10</sup> *Ibid.*, ii, pp. 88 f.

<sup>11</sup> See above, note 8.

<sup>12</sup> *Positive Philosophy*, ii, pp. 131 f., 288, 554 ff.

The impelling factor in progress according to our author is the affectional nature or heart including the appetites, passions and sentiments<sup>1</sup> or about what Ward<sup>2</sup> means by desires and Ratzenhofer<sup>3</sup> and Small<sup>4</sup> by interests; the guiding factor, however, is the intellect going through the three stages of development both in the individual and in civilization as a whole. Although there is in the individual and society a tendency to development, there are certain accelerating factors such as *ennui*, duration of life and increase of population.<sup>5</sup> Race and climate are factors to be reckoned with and also, within narrow limits, political action.<sup>6</sup> A consideration of the last gives occasion for the exposition of his doctrine of political opportunism, an exceedingly suggestive and valuable contribution to political economy. This is a corollary of his general theories of social evolution and relativism, and signifies merely that society cannot be radically changed by legislation which is the expression of the will of an individual or of collective individuals. Comte holds that the aim of legislation should be rather to accelerate the general movement of evolution. All laws to be effective must be in harmony with the social life and traditions of the people.

After this brief survey we are prepared to consider Comte's contribution to the development of the doctrine of adaptation as a theory of social progress. To be sure Comte did not use the phrase or analyze the doctrine as have later writers but we find with him the kernel which has come to such rich fruitage since.

*Passive Physical Adaptation.*—Before Comte's time Montesquieu, Lamarck and others had emphasized the influence of the material environment on the organism and on society. Comte, though not going so far as some, yet recognized this factor.<sup>7</sup> "It is plain that society, as well as individual beings," he says, "is affected by the circumstances of the earth's daily rotation and

<sup>1</sup> *Positive Philosophy*, ii, pp. 83, 128-130, 156, 257; *Catechism*, p. 234. In the *Polity* heart equals sympathy plus energy. Cf. *A General View*, pp. 119 f.

<sup>2</sup> *Pure Sociology*, pp. 101 f.

<sup>4</sup> *General Sociology*, chs. XXXI, XXXII.

<sup>3</sup> *Infra*, ch. IX.

<sup>5</sup> *Positive Philosophy*, ii, pp. 152 f.

<sup>6</sup> *Ibid.*, ii, pp. 90-92. Public opinion is given prominence in the *Polity*. Cf. *A General View*, ch. III.

<sup>7</sup> *Positive Philosophy*, ii, pp. 57, 116 f.

annual movement; and by the states of heat, moisture and electricity in the surrounding medium; and by the chemical conditions of the atmosphere, the waters, the soil, etc. I need only observe that the effect of these influences is even more marked in sociology than in biology, not only because the organism is more complex, and its phenomena of a higher order, but because the social organism is regarded as susceptible of infinite duration, so as to render sensible many gradual modifications which would be disguised from our notice by the brevity of individual life."<sup>1</sup> Comte, as we have noted, did not accept Lamarck's theory of the development of species as a result of the response of the organism to environmental influences, and in social evolution he believed that inherent race qualities and the general forces behind the evolutionary process were vastly more potent.<sup>2</sup>

*Active Material Adaptation.*—Man's ability to control the forces of nature in the interest of his well-being is with Comte one of the chief tests of progress.<sup>3</sup> "All human progress," he says, "political, moral or intellectual, is inseparable from material progression, in virtue of the close interconnection which, as we have seen, characterizes the natural course of social phenomena. Now, it is clear that the action of man upon nature depends chiefly on his knowledge of the laws of inorganic phenomena, though biological phenomena must also find a place in it."<sup>4</sup>

*Passive Spiritual Adaptation.*—Comte's whole doctrine of relativity is but another way of expressing this principle. He holds that the genius is an age-product;<sup>5</sup> that the preponderating opinions of the people determine morals and politics;<sup>6</sup> and he goes so far as to say that "the happiness of every man depends on the harmony between the development of his various faculties and the entire system of the circumstances which govern his life"; i. e., on both material and spiritual adaptation.<sup>7</sup>

Comte might almost be termed a social realist in his insistence that the individual apart from society is a mere abstraction whereas humanity, or again the general human mind is real.

<sup>1</sup> *Positive Philosophy*, ii, p. 116.

<sup>4</sup> *Ibid.*, ii, p. 118.

<sup>2</sup> *Ibid.*, ii, pp. 92 f.

<sup>5</sup> *Ibid.*, ii, p. 92.

<sup>3</sup> *Ibid.*, i, pp. 223, 363, 393; ii, pp. 57, 118.

<sup>6</sup> *Ibid.*, i, p. 14; ii, pp. 30, 165.

<sup>7</sup> *Ibid.*, ii, p. 87. Cf. Caird, *The Social Philosophy and Religion of Comte*, p. 25.

He thus approaches the theory of many modern sociologists who hold that society is a psychological organism. This fact of psychical unity, according to Comte, distinguishes sociology from biology which makes the individual organism the unit of investigation. After setting forth this contrast he says: "The evolution of the individual mind can disclose no essential law: and it can afford neither indications nor verifications of any value unless brought under the methods of observation taught by the evolution of the human mind in general."<sup>1</sup>

This doctrine furnishes the key to this theory of education: "The sociological theory requires that the education of the individual should be a reproduction, rapid but accurate, of that of the race. In his brief career, he must pass through the three stages which an aggregate of nations has wrought out with infinite comparative slowness; and if any material part of the experience is evaded, his training will be abortive."<sup>2</sup> Comte thus reaches deductively a theory of recapitulation very much like that of some modern psychologists and pedagogues which they claim to have reached by inductive methods. The individual mind is real then, and able to perform its functions, according to our author, only as it partakes of the general mind, or is produced and moulded by it,—and this is a form of *passive spiritual adaptation*.

Another point emphasized by Comte, bearing on this doctrine, is his theory of the family as a training school for social adjustment.<sup>3</sup>

*Active Spiritual Adaptation.*—Reacting as Comte did upon the methods of social reconstruction of his day, we might have expected that he would have gone to the other extreme as did Spencer and Gumpłowicz, but instead we find a compromise,—a recognition of natural law but also a law possible of modification by human intelligence and effort. "Though modifications from all causes," he says, "are greater in the case of political than of simpler phenomena, still they can never be more than modifications: that is, they will always be in subjection to those

<sup>1</sup> *Positive Philosophy*, ii, p. 509.

<sup>2</sup> *Ibid.*, ii, p. 510.

<sup>3</sup> *Ibid.*, ii, p. 133.

fundamental laws, whether statical or dynamical, which regulate the harmony of the social elements, and the filiation of their successive variations. There is no disturbing influence, exterior or human, which can make incompatible elements co-exist in the political system, nor change in any way the natural laws of the development of humanity. What then are the modifications of which the social organism and social life are susceptible, if nothing can alter the laws either of harmony or of succession? The answer is that modifications act upon the intensity and secondary operation of phenomena, but without affecting their nature or their filiation. In the intellectual order of phenomena, for instance, there is no accidental influence, nor any individual superiority, which can transfer to one person the discoveries reserved for a subsequent age, in the natural course of the human mind; nor can there be a reverse case of postponement.”<sup>1</sup> This gives rise to his theory of opportuneness which, though carried too far, contains a truth that needs to be re-emphasized in these days of legislative radicalism.

Comte's theory of social control is tersely expressed in these words: “It is the social function of mind to struggle perpetually, in its own way, to modify the necessary rule of material power, by subjecting it more and more to respect for the moral laws of universal harmony, from which all practical activity, public and private, is apt to revolt, for want of loftiness of view and generosity of sentiment. Regarded in this way, legitimate social supremacy belongs neither to force nor to reason, but to morality, governing alike the actions of the one and the counsels of the other. . . . This spiritual authority will be naturally kept within bounds by the very nature of its functions, which will be those of education, and the consultative influence which results from it in active life; and again, by the conditions imposed on their exercise, and the continuous resistance which must be encountered, — the authority itself being founded on free assent, within the limits necessary to guard against abuse. . . . The disposition to seek in political institutions the solution of all difficulties whatever is a disastrous tendency of our time.”<sup>2</sup>

<sup>1</sup> *Positive Philosophy*, ii, pp. 90-92.

<sup>2</sup> *Ibid.*, ii, p. 471.

Thus government is to rest on the free consent of the governed and be a spontaneous expression of social demands based on moral considerations which place the good of all above that of the individual.

There is to be a separation of spiritual and temporal authority yet the two are expected to work in harmony. The spiritual authority will be supreme in matters of education but consultative in what concerns action, while the temporal authority will be supreme in matters of action with consultative power in matters of education. Comte's educational ideal is modern with emphasis on the studies that make for active adaptation, i. e., power over the forces of nature and such development of the moral instincts as shall make for social well-being. "The direct effect of a universal education is to place every one in the situation best adapted to his abilities, whatever his birth may have been."<sup>1</sup>

Comte recognizes the historic value of religion as a factor in social progress, holding that, though an illusion, it is indispensable to active adaptation.<sup>2</sup> He values also its function in social organization and its place in providing a permanent speculative class. "It is a radical property of the theological philosophy to be the sole support of man's moral courage, as well as the awakener and director of his intellectual activity. . . . Feeble as are the intellectual organs, relatively considered, the attractive moral perspective of an unbounded power of modifying the universe, by the aid of supernatural protectors, must have been most important in exciting mental action. In our advanced state of scientific progress, we can conceive of the perpetual pursuit of knowledge for the sake of the satisfaction of intellectual activity, joined to the tranquil pleasure which arises from the discovery of truth; yet it is doubtful whether such natural stimulus as this would always suffice without collateral instigations of glory, of ambition, or of love and stronger passions, except in the case of a very few lofty minds. . . . In the working out of such speculation, the mental activity can be sustained by nothing short of the fictions of the theological philosophy about the supremacy of man and

<sup>1</sup> *Positive Philosophy*, ii, p. 485. Cf. *A General View*, pp. 91, 189, 192-194.

<sup>2</sup> *Positive Philosophy*, i, p. 4.

his unbounded empire over external nature."<sup>1</sup> This evaluation of the idealizing function of the mind is elaborated in the *Système* and in the *Subjective Synthesis*, and as made concrete in the sacerdotal order of positivism appears to most people grotesque, yet it contains an element of truth. Whether an illusion or not, religion is a power in life that makes for individual and social success, and using Comte's pragmatic test the very fact that it works gives us good reason for believing that it is not a mere fiction of the mind.<sup>2</sup>

There was to be a social hierarchy under positivism yet based not on force, or privilege, but on ability with equal opportunity to each. This, he grants, would result in inequality in wealth, but "the positive philosophy will show that it is of small importance to popular interests in what hands capital is deposited, if its employment is duly useful to society at large; and that condition depends much more on moral than on political methods. No jealous legal provision against the selfish use of wealth, and no mischievous intervention, paralyzing social activity by political prohibition, can be nearly so effectual as general reprobation, grounded on an ascertained principle under the reign of positive morality."<sup>3</sup> Thus social control, according to our author, is a potent factor in social progress, but to be effective it must be based on a knowledge of the laws of social development, and be inspired by a desire to enhance the well-being of humanity at large.

It is commonly stated that the two leading teachings of the *Positive Philosophy* are the law of the three stages and the hierarchy of the sciences, but most fundamental of all is Comte's conception of all humanity forming a living, growing entity or "general mind." The doctrine as developed may be stated as follows: (1) Society is an organism, (2) with a structure in which all parts are co-ordinated, each adapted to the whole and to its function, (3) each stage in the process of development growing out of the past, growing into the future and adapted to its environ-

<sup>1</sup> *Positive Philosophy*, ii, pp. 164, 165. Cf. *A General View*, pp. 364 ff.

<sup>2</sup> Cf. Carver, *The Religion Worth Having*, p. 89.

<sup>3</sup> *Positive Philosophy*, ii, p. 486.



ment both material and social. (4) In this evolutionary process the intellect leads, furnishes the pattern and makes possible material achievement and social teleosis, and finally, (5) the heart, including the desires and emotions, is the impelling force.<sup>1</sup> The first is essential to his ethics of altruism and his religion of humanity for he had discarded all supernatural sanctions and needed something to take their place. The second supplies the key to his static sociology with its doctrine of consensus. The third furnishes his theories of social continuity, social prophecy and relativism. The fourth issues in his law of the three periods as the interpreter of the historic process, in his teaching concerning active material and social adaptation with the corollary of political opportunism. The fifth supplies the dynamic of social progress, of his altruistic ethics and of his positive polity based on love and on his religion of humanity.

This fiction of a general mind, however, not only does not correspond to reality, but it partially closed the eyes of Comte to two great realms of sociological investigation: first, to the actual state of disorder and mal-adaptation, attention to which has led to the modern studies in social pathology and social control, and second, to the processes, forces and methods of social evolution which are now being studied inductively as well as those of biological evolution.

His assumption of an impulse to orderly development,<sup>2</sup> very like the preformation theory of early biologists, is highly metaphysical and so unwarranted from his theory.<sup>3</sup> There is no such thing as a general human mind that has developed from primitive to modern times. There is, to be sure, the phenomenon of so-called social heredity or the transmission of acquired knowledge and experience from generation to generation through imitation, tradition, custom and education. There is, too, the fact of similarity of individual mental processes in all ages, so far as we know, and similarity in the laws of psychic interaction so that, as Ross points out, "those social phenomena which lie

<sup>1</sup> In the *Polity* evaluated above the intellect.

<sup>2</sup> *Positive Philosophy*, ii, pp. 75-85.

<sup>3</sup> Cf. Ward, *Pure Sociology*, p. 381.

nearest the subjective focus will exhibit in their transformations a certain logic and regularity,"<sup>1</sup> but there is the other focus in social evolution, the objective. "Environments," Ross continues, "impose modes of existence extremely unlike, and therefore in differently situated social groups those social phenomena lying nearest the objective focus will undergo not parallel but divergent evolution." The discovery and working out of these problems was reserved for later sociologists under the inspiration of Darwin's painstaking labors in biological evolution.

Comte might have made more progress along these lines in his later years, aided by advance not only in biological but in mental and historical science had it not been that he was obsessed by the logical fiction of his early treatise, was busied with the elaboration of his positive polity and moreover, was led astray by his theory of "cerebral hygiene" which closed his mind to the scientific truths discovered in the later years of his life.

In spite, however, of these short-comings, so great has been his contribution to social science and social philosophy that a modern authority says: "The broad and general lines on which he sketched the outlines of social science have formed the basis of all attempts since. Much of his filling in was crude, but some was of permanent value. He indicated correctly the true nature and scope of the science and the proper method of investigation to be followed."<sup>2</sup>

Sociological organicists may well claim Comte as their master, so too, the biological and the classifying schools. In basing social evolution on the development of mind he is in line with genetic psychologists. In suggesting the importance of material achievement as the basis of cultural, he was a forerunner of Ward, Carver and others; in his emphasis on desires as the impelling forces to progress his position was very much like that of Ratzenhofer and Small; in his doctrine of social teleosis and political opportunism, he pointed the way to rational social control as generally accepted today by social scientists. Comte's *Positive Philosophy* may thus not inaptly be denominated a Prolegomenon to Sociology.

<sup>1</sup> *Foundations of Sociology*, p. 62.

<sup>2</sup> F. Spencer Baldwin, *Class Lectures*.

## CHAPTER II

HERBERT SPENCER (1820-1903)

### COSMIC EVOLUTION

As the naturalistic philosophy of eighteenth-century France and the social enthusiasm of the early nineteenth century were strangely fused in the life and social philosophy of Auguste Comte, so the England of Sir William Hamilton, Adam Smith, Lyell, Watts, and Shaftesbury, — the England at once scientific, industrial, moral and religious, found expression in the life and Synthetic Philosophy of Herbert Spencer. To appreciate his theories of evolution and adaptation one needs to understand the unfolding of his life and thought and this is revealed in his published autobiography and letters with a frankness and keenness of self-analysis that is illuminating.

The son of an English school-master, of a line of non-conformist ancestors, breathing from earliest days the atmosphere of intellectual and religious freedom and himself taught to question, to observe, and to reason, Spencer grew up through boyhood a student of nature, a questioner, a seeker after causes in a law-abiding order.

An only child, left much to the companionship of his own thoughts, he became a dreamer. Allowed to have his own way, and deprived of the opportunity of developing his social nature normally through play with other children, when in youth he did mingle with others, he found the problem of social adjustment a severe task, and out of this experience was born his theory of moral compromise, — of rational adjustment between egoism and altruism. He refused the opportunity of a university career and turned to engineering where for several years he struggled along, dividing his time between drawing, field-work, inventing, study, and writing.

The reading of Lyell's *Principles of Geology* when twenty years of age marked a crisis in Spencer's life, for it turned his attention to the theory of evolution as against creationism as a method of explaining the origin of species. Lyell's attempt to refute Lamarck, however, made him a believer in Lamarck's hypothesis.

Professor Royce thus summarizes the development of Spencer's thought as revealed in his autobiography: —

First, came a love for tracing the causes of things, a love which early led to the notion that nature permitted no miracles, that all processes of nature are unbroken and continuous, and that all which is beyond the realm of discoverable law is altogether unknowable. Second, came an assurance that, even as he himself was of an independent spirit, so no man's liberty ought to be hindered, so long as such a man did not interfere with his neighbor's liberty. Third came, slowly growing in his mind, the assurance that the "development theory" must account for living things, by means of a natural process, just as causation in general was needed to account for every other natural event and product. Next came the notion that, in particular, the life of the mind must be understood as a development, determined by natural causes, and connected with the development of all the phenomena of life. Finally came the conviction that a full and coherent theory of nature, in which the organic and inorganic worlds were united by the working of universal laws, not only would explain, so far as that was possible, the growth of things, but also would furnish a systematic and complete foundation for his own never changing individualistic ethics, and for his sturdy, old-fashioned British liberalism. In this way, the main work of Spencer's life came to be an effort to bring into synthesis an organic theory of the unity of the evolutionary process, with a doctrine regarding the freedom and the rights of the individual which had come down to him from an age when evolution and the organic unity of things had indeed interested Englishmen but little. This particular synthesis of organic evolution with individual independence remains one of the most paradoxical, and consequently most instructive, features of Spencer's teaching.<sup>1</sup>

Turning to a consideration of the teachings of Spencer which bear directly on our subject we find the following: —

1. *Society an Organism.* — Spencer's method in this discussion is analogical. He mentions four similarities and four dissimilarities between society and a biological organism. The former are *continuous growth, increasing complexity, increasing dependence of parts, and possible independent life of organism and member.* The four dissimilarities are *lack of specific external form in the case of society, units discreet and dispersed* instead of continuous, *mo-*

<sup>1</sup> *Herbert Spencer*, pp. 63-64.

*bility of parts and separate centers of feeling.*<sup>1</sup> He concludes, however, that the similarities are so much more striking than the dissimilarities that the use of the analogy is legitimate. This theory is not essential to Spencer's system as it was to Comte's, and in reply to criticism he holds that the only analogy alleged is community in the fundamental principles of organization. "I have used the analogies elaborated but as a scaffolding to help in building up a coherent body of analogical inductions. Let us take away the scaffolding: the inductions will stand by themselves."<sup>2</sup> Society, then, according to our author is a quasi-biological organism.

Spencer is more definite in his concept of the content of that society which is like an organism than is Comte, yet does not face the question squarely as have some later sociologists. His thought is most clearly expressed where he says: "It is the permanence of the relations among component parts which constitutes the individuality of a whole as distinguished from the individuality of its parts"; and again where he defines society as an entity, "because, though formed of discrete units, a certain concreteness in the aggregate of them is implied by the general persistence of the arrangement among them throughout the territory occupied."<sup>3</sup> This seems to imply a sovereign group, and corresponds roughly to a biological species. He uses the term with the same meaning also in Part III where he contrasts the diverse interests of the species, of the parents and of the offspring.<sup>4</sup>

2. *Social Evolution interpreted in Terms of Cosmic Evolution.* — Spencer, as Comte, divides sociology into social statics and social dynamics but with difference in meaning. With the latter statics had to do with relations of co-existence and dynamics with relations of sequence, corresponding roughly to social anatomy and social physiology. With the former static is defined in the mechanical terms of equilibrium of forces and dynamic in those of dis-equilibrium.

<sup>1</sup> *Sociology*, i, pt. 2, ch. II; also *Illustrations of Universal Progress*, chapter on "The Social Organism." For Ward's criticism, see *Am. Journ. Soc.*, vii, pp. 493 ff.

<sup>2</sup> *Sociology*, i, p. 592.

<sup>3</sup> *Ibid.*, i, pp. 447, 448.

<sup>4</sup> *Ibid.*, pp. 603 f., esp. p. 610.

Spencer's theory of social progress, though nowhere elaborated, is brought out in his summary of the application of the general laws of evolution to the social process.

The many facts contemplated unite in proving that social evolution forms a part of evolution at large. Like evolving aggregates in general, societies show integration, both by simple increase of mass and by coalescence and recoalescence of masses. The change from homogeneity to heterogeneity is multitudinously exemplified; up from the single tribe, alike in all its parts, to the civilized nation, full of structural and functional unlikeness. With progressing integration and heterogeneity goes increasing coherence. We see the wandering group dispersing, dividing, held together by no bonds; the tribe with parts made more coherent by subordination to a dominant man; the cluster of tribes united in a political plexus under a chief with sub-chiefs; and so on up to the civilized nation, consolidated enough to hold together for a thousand years or more. Simultaneously comes increasing definiteness. Social organization is at first vague; advance brings settled arrangements which grow slowly more precise; customs pass into laws which, while gaining fixity, also become more specific in their applications to varieties of actions; and all institutions, at first confusedly intermingled, slowly separate, at the same time that each within itself marks off more distinctly its component structures. Thus in all respects is fulfilled the formula of evolution. There is progress towards greater size, coherence, multiformity, and definiteness.<sup>1</sup>

The sociological unit, corresponding to the cell in biological evolution, is primitive man with certain qualities, physical, emotional and intellectual;<sup>2</sup> yet other unities are given prominence as the primitive horde,<sup>3</sup> later the family,<sup>4</sup> and finally the sovereign group or nation.<sup>5</sup>

Men thus endowed form the internal or intrinsic factors in the social process but this process is determined by the extrinsic factors, climate, surface, flora, fauna and their interaction<sup>6</sup> and by the super-organic environment of each group, made up of other groups.<sup>7</sup>

Very little attention is given by our author to an analysis of the social process,<sup>8</sup> his chief purpose being to show that it corresponds to evolution in general so is considered to be almost

<sup>1</sup> *Sociology*, i, pp. 596, 597.

<sup>2</sup> *Ibid.*, p. 9, also p. 437. Cf. Barth's criticism, *op. cit.*, p. 100.

<sup>3</sup> *Sociology*, pp. 464 f., 550. Cf. *Laws of Univ. Prog.*, p. 399.

<sup>4</sup> *Sociology*, pp. 437, 711.

<sup>6</sup> *Ibid.*, i, p. 9, ch. III.

<sup>5</sup> *Ibid.*, p. 603; ii, pp. 569 f.

<sup>7</sup> *Ibid.*, p. 12.

<sup>8</sup> Cf. *Social Statics*, pp. 77 ff., *Sociology*, iii, p. 609.

entirely a process of unconscious, gradual adjustment by means of such phenomena as increase of population together with economic pressure, conflict of groups, psychic interaction between individuals and the group and such super-organic products as tools, language, knowledge, laws, and works of art.<sup>1</sup> Social evolution further results from the inheritance of acquired adaptations both biological and sociological<sup>2</sup> and by the natural selection.<sup>3</sup> That group will survive, grow and ultimately "possess the land" that has the best family system, the most efficient methods of production and distribution and the best government.

Spencer recognizes only two distinct stages of social progress, the military and industrial. Compulsory co-operation is characteristic of the former, voluntary co-operation of the latter. Under militarism we have social progress by multiplication of homogeneous units, grouping and compound grouping with ever increasing efficiency of organization and division of labor.<sup>4</sup> Under industrialism little corporate activity is required<sup>5</sup> hence a less complicated and centralized political organization.<sup>6</sup> The contrast is well expressed thus: "In a society organized for militant action, the individuality of each member has to be so subordinated in life, liberty and property, that he is largely or completely *owned* by the state. . . . Under the industrial régime the citizen's individuality, instead of being sacrificed by the society, has to be defended by the society. Defence of his individuality becomes the society's essential duty."<sup>7</sup>

When, according to Spencer, with the abolition of inter-group conflict "there remains only the industrial struggle for existence, the final survival and spread must be on the part of those societies which produce the largest number of the best individuals, — individuals best adapted for life in the industrial state."<sup>8</sup>

With simplification and decentralization of government, however, comes an increase of industrial organization, yet not at the expense of individual freedom as in the former case.<sup>9</sup> Industrial-

<sup>1</sup> *Sociology*, i, pp. 11 ff.

<sup>2</sup> *Ibid.*, p. 549.

<sup>3</sup> *Ibid.*, p. 652; ii, pp. 601, 268, 569 f., 610; iii, pp. 581 f.

<sup>4</sup> *Ibid.*, i, pp. 466 ff.; ii, pp. 568 ff.

<sup>7</sup> *Ibid.*, p. 607.

<sup>5</sup> *Ibid.*, ii, pp. 606 f.

<sup>8</sup> *Ibid.*, ii, p. 610.

<sup>6</sup> *Ibid.*, p. 612.

<sup>9</sup> *Ibid.*, pp. 613, 632.

ism, moreover, leads to a breaking down of national barriers and the development of world-federations.<sup>1</sup> It also leads to a decrease of individual bitterness and revengefulness, hence of anti-social acts.<sup>2</sup>

Along with the change from militarism to industrialism are manifold sociological changes co-ordinated with it. In Spencer's discussion of the evolution of social institutions he shows not only how the changes are brought about in harmony with the general laws of evolution which he has formulated, but also how in each case the structure, functions and changes are correlated with the movement from militarism to industrialism. The six institutions whose evolution is thus described are the domestic, ceremonial, political, ecclesiastical, professional and industrial.

3. *Tests of Progress.* — Our author, as we have noted, makes increasing complexity the general test of progress. More specifically, the test of individual well-being is measured by length of life multiplied by breadth, this latter made up of "the aggregate of thought, feeling and action";<sup>3</sup> the test of industrial progress is increase of division of labor, and also increase of interdependence;<sup>4</sup> the test of intellectual progress is the ever increasing power of complex mental operations;<sup>5</sup> the test of moral development is increasing adjustment of acts to ends, the ends including both self-maintenance and race-maintenance.<sup>6</sup> For the individual this last test includes increase of well-being<sup>7</sup> which calls for progressive adjustment to an ever increasing complexity of social relations<sup>8</sup> and also such activity as furthers the well-being and adjustment of fellow-men.<sup>9</sup> The test of social progress is increase of complexity in social life and institutions and in social interdependence.<sup>10</sup> The test of religious progress is

<sup>1</sup> *Sociology*, pp. 615 ff.

<sup>2</sup> *Ibid.*, p. 636.

<sup>3</sup> *Data of Ethics*, p. 14.

<sup>4</sup> *Illustrations of Universal Progress*, p. 404; *Sociology*, iii, p. 410.

<sup>5</sup> *Ibid.*, i, ch. VII; *Principles of Psychology*, sections 484-493.

<sup>6</sup> *Data of Ethics*, p. 17.

<sup>7</sup> *Ibid.*, pp. 37, 49 f.

<sup>8</sup> *Ibid.*, pp. 20, 21, 87; *Sociology*, iii, pp. 608 ff.

<sup>9</sup> *Data of Ethics*, p. 27.

<sup>10</sup> *Illustrations of Universal Progress*, pp. 2, 403; *Sociology*, i, pt. 2, ch. IV; also p. 597; iii, p. 410.



increasing complexity in religious institutions and functions but with a simplification of doctrine until it consists merely in belief in and adoration of the infinite but unknowable source of all.<sup>1</sup> The test of political progress is for a time increasing differentiation and integration but ultimately decentralization in the interest of individual liberty and well-being, until it is merely negative-regulative.<sup>2</sup>

Spencer's specific contribution to the doctrine of adaptation as a theory of social progress began as early as 1843 when he wrote *The Proper Sphere of Government* and reached its highest development in *Social Statics* written in 1861. His own summary of the principles as there elaborated is given in his *Autobiography*:—

Everything was referred to the unvarying course of causation, no less uniform in the spheres of life and mind than in the sphere of inanimate existence. Continuous adaptation was insisted on as holding of all organisms, and of mental faculties as well as bodily. For this adaptation, the first cause assigned was the increase or decrease of structure consequent on increase or decrease of function; and the second cause assigned was the killing off, or dying out, of individuals least adapted to the requirements of their lives. The ideally moral state was identified with complete adjustment of constitution to conditions; and the fundamental requirement, alike ethical and political, was represented as being the rigorous maintenance of the conditions to harmonious social co-operation; with the certainty that human nature will gradually be moulded to fit them.

The dependence of institutions upon individual character was dwelt on; the reciprocal influences of the two emphasized; and the adjustment of moral ideas to the social state illustrated. A physiological view of social actions was taken; on sundry occasions the expression "social organism" was used; the aggregation of citizens forming a nation was compared with the aggregation of cells forming a living body; the progress from a whole made up of like parts which have but little mutual dependence to a whole made up of unlike parts which are mutually dependent in a high degree, was shown to be a progress common to individual organisms and social organisms. So that the conception of progress subsequently to be presented in a more generalized form, was evidently foreshadowed.<sup>3</sup>

We thus have two principles of evolution or tests of progress: that of continuous adjustment and that of increasing differentiation and integration, the former taking into consideration the

<sup>1</sup> *Sociology*, iii, ch. XVI.

<sup>2</sup> *Ibid.*, i, pp. 494 ff., 598 ff.; ii, pp. 643 ff.

<sup>3</sup> *Autobiography*, ii, p. 8. Cf. Hudson, *Philosophy of Herbert Spencer*, pp. 43, 44.

relation between the organism and its environment, the latter, the structure and functions of the organism. Now these two principles or tests are not always in agreement. Mention has already been made of Spencer's exception in the case of government, turning aside from his universal principle in the interest of individual well-being, thus returning to his principle of *adaptation*. The same conflict is to be noted in his discussion of the family. He shows that there has not been any one line of development from promiscuity to monogamy but that the order has depended on economic conditions, i. e., on the principle of adaptation. That the individual and social goal is adaptation and survival rather than mere increasing complexity (if indeed we are warranted in speaking of a goal in a naturalistic system) is brought out in this same discussion: "Family organizations of this or that kind have first to be judged by the degrees in which they help to preserve the social aggregate they occur in, for in relation to its component individuals, each social aggregate stands for the species. Mankind survives not through arrangements which refer to it as a whole, but by survival of its separate societies, each of which struggles to maintain its existence in presence of other societies. And survival of the race, achieved through survival of its constituent societies, being the primary requirement, the domestic arrangements most conducive to survival in each society must be regarded as relatively appropriate."<sup>1</sup> The standard of right thus expressed is not a final test, however, but such as belongs to the pre-perfect social state whereas under complete industrialism and world-federation, the standard of right is no longer group utility and survival but "the liberty of each limited only by like liberty of others." The group ethics of the preliminary stages is thus very like that of Galton, Carver and others whom we shall consider later.

Our author admits that survival may necessitate a return to a simpler form but this he considers retrogression, thus placing increasing complexity as a higher test of progress than adaptation. He never seems to have faced this problem squarely and thought it through. Increasing differentiation and integration is

<sup>1</sup> *Sociology*, i, p. 610.

a formal or structural test whereas increasing adaptation is a life test. This point has weighty moral and religious implications. The *summum bonum* of individual and group life should be revealed by a study of cosmic and especially of social evolution, and if we are theists we may believe that God's will is there revealed. Now if increasing differentiation and integration is the one all-inclusive formula of life and progress, every individual should seek to hasten this process in his own life, so, too, should each group, though it lead to destruction. To theists, this would be God's will. If, on the contrary, progressive adaptation is the law of life, every individual should seek to further the process in his own life, so, too, should every group, though it call for a return to a simpler form, — which Spencer terms retrogression. In this case *retrogression would mean progression* for it would mean increased adaptation to a change in the environment requiring such simplification for survival. Whether or not such simplification is possible for a group is a mooted question but it certainly is possible for an individual.

In his *Principles of Ethics* adaptation again comes to the front as the test of the good. Moral conduct is there defined in two ways: as "acts adjusted to ends" and as "the adjustment of acts to ends." Spencer does not seem to have appreciated the significance of the difference in these two statements but they may be interpreted very differently, the first signifying merely passive adaptation, the second, active adaptation, because the process issues from intelligent purpose. With him the distinction is merely between emphasis on the formed body of acts or on the form alone.<sup>1</sup>

Spencer does give some place to purpose, to be sure, in his discussion of conduct, but nowhere does he bring out the contrast between conduct that *happens to be adjusted* and conduct that is *purposely adjusted*. This is shown by the following quotations: "We are able to furnish no other test of perfection than that of complete power in all the organs to fulfil their respective functions."<sup>2</sup> "The perfection of man considered as an agent means the being constituted for effecting complete adjustment of acts to

<sup>1</sup> *Data of Ethics*, p. 4.

<sup>2</sup> *Ibid.*, p. 36.

ends of every kind.”<sup>1</sup> “ Given its environment and its structure, and there is, for each kind of creature a set of actions adapted to their kinds, amounts, and combinations, to secure the highest conservation its nature permits.”<sup>2</sup> All conduct, that is, fits into one scheme of things and only *one line* of action can be *fitting* hence good. The total pressure of heredity, of material and social environment tends to force a man into this line of conduct. The normal man reacts approximately in the fitting way hence is good; the abnormal man fails to react properly, that is, fittingly, hence may be pronounced bad.<sup>3</sup> We have thus a doctrine of relativity similar to that of Comte with this difference: with the latter ethics is relative until made absolute under the positive régime while with the former there can be no absolute system until the ideal state of social equilibrium is reached, — a state made up of ideal men each perfectly adapted to the whole.<sup>4</sup>

With Spencer, as we noted in our introduction, adaptation is a five-fold process: that of the individual to his material<sup>5</sup> and social environment and that of the group to the well-being of its members, to its material environment and to other societies, i. e., to its super-organic environment.

Spencer's failure to emphasize active adaptation or “telesis” was due to several causes: —

<sup>1</sup> *Data of Ethics*, p. 37.

<sup>2</sup> *Ibid.*, p. 152.

<sup>3</sup> Cf. Mackintosh's interpretation of Spencer: “The morally good society is the typically human society; the morally good individual, so far as he is good, is qualified for membership in that society,” *op. cit.*, p. 109. Cf. *Social Statics*, pp. 77 f.

<sup>4</sup> *Data of Ethics*, p. 83.

<sup>5</sup> In Spencer's *Education* published as early as 1860 we have his only important contribution to the doctrine of active material adaptation (though the phrase is not used), where, along with emphasis on the knowledge that insures health, stability of the family, maintenance of wholesome social relations and the satisfaction of the tastes and feelings, stress is placed on the knowledge that gives power over nature so that with increased productivity will come the material essentials for “complete living.” Yet even in this treatise which has been one of the most potent factors in the modern movement for an education which fits for success in life, the main emphasis is on passive adaptation as shown in his discussion of “punishment,” in his insistence that education is to fit the child for the world as he finds it rather than for an ideal social order, and in his repeated use of the dictum “follow nature” without making clear that nature includes man and social groups with power to react on it purposefully in the interest of the largest possible individual and social life.

1. His whole system is formal, abstract and logical. Bergson characterizes his evolution theory as false because it “consists in cutting up present reality already evolved, into little bits no less evolved, and then recomposing it with these fragments, thus positing in advance everything that is to be explained.”<sup>1</sup> Professor Bowne delighted to speak of his method of confusing logical classification with genetic order, as the “fallacy of the universal.”<sup>2</sup>

2. His explanation is essentially mechanistic. He endeavors to interpret the complexities of psychical and social life in terms adequate to describe only movements of lifeless matter. Mackintosh shows how inadequate is his theory to explain organization, consciousness and history,<sup>3</sup> and Sir Arthur Thomson, while recognizing that Spencer was using mere symbols to express the workings of the unknown reality, points out that these symbols are entirely inadequate to represent the genesis of life and mind. “No one can doubt,” he says, “that development is progressive differentiation, but it is rather a realization of a complex inheritance of materialized potentialities than a change from an incoherent, indefinite homogeneity to a coherent, definite heterogeneity.”<sup>4</sup> The mechanical laws of multiplication of effects, of rhythm<sup>5</sup> and of the tendency to equilibrium are thus entirely inadequate to explain social evolution.

3. Spencer’s assumption of an inherent tendency to development in the cosmos together with his belief in use-inheritance and natural selection, render his explanation much easier than is really the case. The first assumption is hyper-scientific, the second has been all but disproven and the third has been questioned so seriously in its application to social progress that his general theory has been greatly weakened.

4. His emphasis on the importance of economic factors has been accentuated since; but he failed to appreciate the distinction between uneconomic and economic competition; i. e., between the competition that is destructive of human energy and

<sup>1</sup> *Creative Evolution*, pp. xiii, xiv. Cf. also pp. 364-391.

<sup>2</sup> *Class Lectures*.

<sup>3</sup> *Op. cit.*, p. 91.

<sup>4</sup> *Herbert Spencer*, p. 115. Cf. also pp. 103, 140, 211, 212.

<sup>5</sup> For criticism of his use of law of rhythm, see Schiller, “Herbert Spencer,” *Encyclopædia Brit.*, xiii ed.

diminishes social welfare and the competition that tends to develop and encourage the multiplication of the most efficient men and methods and increases social welfare. The one should be prevented, the other encouraged by social control.<sup>1</sup>

5. Spencer failed to appreciate the function of intelligence in "short circuiting" the normal processes of nature.<sup>2</sup> Intelligence has as one of its chief functions the economizing of time and energy. Man by "art" abridges the slow process of passive adjustment.

6. Finally his failure to appreciate the functions of social control was due in large measure to his extreme individualism, expressed in religion in non-conformity and free-thought; in economics by *laissez faire* doctrines; in ethics by over-emphasis on egoism; in government, in his theory of decentralization and "negative regulation." "Liberty, equality, justice and fraternity,"—these ideals were for him the interpreters of the social process in its final stages. This point of view led him to see only those acts of Parliament that were over-paternalistic and had proven a failure, and blinded him to the many successful measures that had been passed. Despite these short-comings, however, his doctrine of passive adaptation as developed in *Social Statics* and illustrated in his *Principles of Sociology* stands as one of the great principles of social progress, a process which was destined to be analyzed by more keenly analytic students inspired by the more strictly scientific methods of men like Darwin.

<sup>1</sup> For development of this distinction see discussion of Professor Carver's social philosophy.

<sup>2</sup> Cf. however, note 5, p. 38.

## CHAPTER III

### SOCIOLOGICAL METHODOLOGY

BOTH Comte and Spencer defined life in terms of progressive adaptation between an organism and its environment and both conceived society as a quasi-biological organism, though not agreeing in their conception of society nor of the process of adjustment. Comte's concept was a logical fiction, so also, to a considerable degree, the process of social evolution as formulated by him. Spencer attempted to describe in mechanical terms the historical process by which society, considered for the most part as a sovereign group, is progressively adapted to its environment so also that of the various social institutions; but most of his time was devoted to a study of origins and his method, the logical classification of concepts, failed to give him genetic order, and led him to neglect the study of social forces. Comte was in advance of Spencer in emphasizing the power of mind over matter thus making place for active adaptation.

From Comte and Spencer the development of theories of social progress, of methods of sociological investigation, and as a result of these, the development of the doctrine of adaptation as the key to social philosophy, was along several different lines. Some pushed further than these two the method of classification as a means of attaining knowledge of the social structure and process such as Littré, De Roberty, De Greef, Lacombe and A. Wagner. Some used the same analogical method as they and elaborated the concept of society as a quasi-biological organism, chief among whom were Lilienfeld and Schäffle. Others making use of the neo-Darwinian formula, as Nietzsche, Kidd, and Lapouge, endeavored to explain social progress in terms of struggle and survival. Others interpreted society as a quasi-psychological organism as Le Bon, MacKenzie, Fairbanks, Ely, Giddings and Baldwin. Others, still, sought to analyze and evaluate social

forces, some of whom, following the lead of Quêtelet, made use of the statistical method, as Buckle, Galton, and Pearson, while others, under the inspiration of Darwin, turned to an inductive study of social facts and forces as Ratzenhofer, Gumpłowicz and the modern school of social scientists such as Le Play, Booth, Rountree and the eugenicists, — represented in England by Galton and Pearson and in America by Davenport, — and a final group have endeavored to explain social progress in terms of some one law or principle as Tarde and Giddings.

As method is so important in any department of investigation, especially in one that is new, and inasmuch as an appreciation of the method used by an author often furnishes a valid means of criticizing his conclusions, it may be well to devote some place to a brief discussion of sociological methodology in general and of some methods as illustrated by specific writers in this field whose contribution to the development of the doctrine of adaptation has been indirect rather than direct.

When Comte and Spencer wrote, the deductive method reigned almost supreme in social science, and though they prided themselves on breaking away from the methods of the past, they were still, to a considerable extent, fettered by their training. Malthus, Quêtelet, and a few others, indeed, had turned their attention seriously to a scientific study of social phenomena but their followers were few.

Comte turned his attention to this subject holding that the same inductive methods in vogue in biology were, with some modification, applicable in sociology, viz., observation, experiment, and comparison, with the promise of a fourth method to be derived from biology, — since fulfilled in the so-called genetic method.<sup>1</sup> Under experiment, Comte mentions only a study of pathological conditions, but despite Mill's teaching concerning the inapplicability of this method in social investigations,<sup>2</sup> we have come to realize the possibility of arranging social conditions and forces by forethought much as does the worker in the physical or chemical laboratory, although as the phenomena are so much more complex, and the time required to try out the experiment is

<sup>1</sup> *Positive Philosophy*, ii, ch. II.

<sup>2</sup> *Logic*, ch. VII.



so great, the process is difficult and the results more or less uncertain. Under the comparative method, according to Comte, we have comparison between society and animal groups, between co-existing states of society and between consecutive stages in social growth. A combination of this last and of the method derived from biology has given rise to the historical method,<sup>1</sup> where the purpose is not merely to deduce general laws from specific historical events but to discover the "filiation" in successive events. Two other forms of the inductive method have come to have increasing vogue since Comte's time, the statistical method and what might well be termed the "inverse historical" method, i. e., the analysis of current events with the purpose of finding a clue to the interpretation of the past.<sup>2</sup>

In this chapter we will consider Quètelet because of his development of the statistical method and his use of it in studying social phenomena, Lilienfeld as representative of the analogical school and De Greef as representative of those whose social philosophy is based largely on the method of logical classification, and in the following chapter consider Darwin and his successors as representatives of the inductive method.

#### LAMBERT A. J. QUÈTELET (1796-1874)

##### *The Statistical Method*

Such a large place has the statistical method<sup>3</sup> played in all the social sciences during the past half century that some place needs to be given it, and especially to its use in connection with the doctrine of adaptation as a theory of social progress, for it is an instrument of first importance in diagnosing social pathology or mal-adaptation, as it is also in measuring social growth and adaptation.

According to Quètelet, statistics, as a science, dates back no longer than 1820,<sup>4</sup> but M. Block shows that in its essential fea-

<sup>1</sup> *Logic*, ch. X.

<sup>2</sup> Carver, *Sociology and Social Progress*, p. 64.

<sup>3</sup> King, *Elements of Statistical Methods*, ch. I.

<sup>4</sup> M. Block, *Traité de Statistique*, p. 48; Hankins, "Quètelet," *Columbia Univ. Studies*, xxxi, pp. 37 ff.

tures this method was taught by Courning in the University of Helmstadt in 1660, and that a course in statistics was offered at Jena in the early part of the eighteenth century.<sup>1</sup> Although as a science it is of recent date, enumerations of population and calculations concerning other social phenomena antedate the birth of Christ more than 2000 years.<sup>2</sup> The word law was first used in statistics by Sussmilch in 1775 to express regularity in the recurrence of social phenomena,<sup>3</sup> but some statisticians have confused this with natural law. M. Block distinguishes the two as follows: "One indicates certainty, the other, probability. . . . In natural laws we are able to follow the relation of cause and effect. We see (as far as our knowledge or experience permits) all the factors in action, we know in advance that the cause will produce the effect. . . . In statistics the relations of cause and effect are less visible, often we can determine only correlations (coincidences) from the *post hoc* rather than from the *propter hoc*, for now the cause remains unknown."

Quêtelet is generally recognized as the first name in the history and development of modern statistical science.<sup>4</sup> His contribution is stated by Hankins to be four-fold: (1) perfection of plans for census taking; (2) criticism of sources; (3) arrangement of materials; and (4) progress toward uniformity and comparability of data.<sup>5</sup> He was the leading spirit in the formation of the Bureau of Statistics in Belgium and in the organization of the Royal Statistical Society of London. Through his influence various nations were led to co-operate in using a standard system of enumeration.

Quêtelet was a contemporary of A. Comte and seems to have influenced him to some extent though Comte finally repudiated the statistical method. His influence on Buckle, however, was profound and the statistical method, made popular among scientists by his writings, has been found of great value by modern sociologists.

Guided by the scientific thought of his day as represented by Lyell, Agassiz, Gray and Hooker, Quêtelet considered each species

<sup>1</sup> *Op. cit.*, p. 5.

<sup>2</sup> *Ibid.*, p. 1.

<sup>3</sup> *Ibid.*, p. 115.

<sup>4</sup> Hankins, p. 36.

<sup>5</sup> *Ibid.*, p. 41.

to be immutable. The normal frequency curve applied to each species revealed the type nature was aiming to produce. Variations from the norm were considered to be due to accidental causes.<sup>1</sup> This law he considered to be of universal application, and it furnished him the background for his doctrine of the "average man" which was one of his great original contributions to anthropology, although we find a similar conception in the writings of Father Buffier.<sup>2</sup> The qualities of this typical man, moral and mental as well as physical, were obtained in the same way. He had not only a certain height, weight, complexion, color of hair and eyes, but a certain intellectual acuteness, temperament, sensitiveness, — in other words a "character," which represented reaction power to physical and social stimuli. Under certain conditions this typical man would react in such a way that society would denominate the action crime or again, suicide, and he considered that the social conditions were on the whole so uniform as to produce regularity in such phenomena. He made no place for progress in either physical or intellectual capacity, but only in the acquirement of knowledge and power over nature.

Quètelet applied the same method to the study of society that he had to the study of the "average man." He is vague in his definition of society but considers it as a "body" in a sense almost as crude as in the use of the term by Hobbes. The nation-type, in his thought, was made up of physical, intellectual and moral factors. He recognized a complexity here, however, which had no analogy in man, for he showed that in stature, for example, sections of a people differed, as city and country dwellers, and also that there were various sectional types.

The statistical method, especially as applied to moral phenomena, seems to some to eliminate arbitrary will; not so, however, with Quètelet who emphasized its importance in individual life,<sup>3</sup> but showed that the free will manifested itself in activities which were a part of the law-abiding order and that considering a group as a whole this element of arbitrariness did not appear as

<sup>1</sup> *Du Système Social*, pp. 257 f.

<sup>2</sup> Quoted and adopted by A. Smith, *Theory of Moral Sentiments*, p. 318.

<sup>3</sup> *Du Système Social*, p. 96.

such. Indeed he went so far as to hold that "les phénomènes sociaux, influencés par le libre arbitraire de l'homme, procèdent, d'année en année, avec plus de régularité que les phénomènes purement influencés par des causes matérielles et fortuites."<sup>1</sup>

The fallacies in Quètelet's argument are all ascribable to two sources, first, his belief in the stability of types, and second, his too rigid application of the organic analogy to a social group. Nevertheless, he shares with Comte, Spencer, and Darwin the honor of being pillars in the building of the new social science.

The statistical method, of utmost value when used with scientific insight, has been misused more than has any other, for its fallacies are less easily observed by the uninitiated. As has been frequently pointed out this method gives us at best only correlations and conditions, not causes; and too often the phenomena compared are not sufficiently alike to warrant the conclusions drawn from the comparison. The results obtained by this method are valid only in proportion as all other things are equal save in the one point of comparison, and this is difficult to obtain in social phenomena.

The advent of Darwin's *Origin of Species* marks a new epoch in sociological methodology and since his day the pure deductive reasoning of the mediaeval philosophers has constantly waned, so too, of late, the endeavor to ground social philosophy on a classification of social phenomena or formulate its principles by analogy. Observation, comparison, compilation of statistics, correct interpretation of the data, experiment, — these are emphasized with increasing vigor, with a proper use, to be sure, of deduction, classification, and analogy.

Before passing to a consideration of Darwin and his successors as representatives of the inductive method and as furnishing the biological background for the theory of adaptation, it will be necessary to consider the importance of the material environment in biological evolution and the contributions of Lamarck.

<sup>1</sup> *Du Système Social*, p. 97.

PAUL VON LILIENFELD (1829-1903)

*The Analogical Method*

Lilienfeld is perhaps the best representative of the analogical school, for though Schäffle has made large use of the organic analogy it is not essential to his system as proven by the fact that in his *Sociology* he dispensed with the concept entirely, and his whole temperament and method, together with his emphasis on the psychical factors in society and social progress, give warrant for placing him in another class.

Lilienfeld may well be termed a social realist for he insists "dass diese oder jene Gesellschaftsgruppe, dieser oder jener Staat *wirkliche*, lebendige Organismen, gleich allen übrigen Organismen in der Nature, sind, die sich im Raum und in der Zeit nicht nur ideell, sondern reell entwickeln und wahrnehmen lassen."<sup>1</sup>

Many likenesses between society and a biological organism are enumerated, the individuals in the former corresponding to the cells in the latter,<sup>2</sup> the political, juridical and industrial institutions corresponding to the central nervous system while the intercellular substance in the body has its analogue in such social achievements as works of art, written laws and ideas, by means of which society projects itself in concrete form.<sup>3</sup>

While holding that there is no break in the cosmic process, yet he shows how the forces working in organic life differ from those in the inorganic realm, becoming ever more active, complex, and differentiated, culminating in freedom and purposeful action.<sup>4</sup> He mentions five ways in which the former shows its superiority to the latter: (1) in the organic cycle of growth and decay activities are never repeated; (2) an organism has an inner unity of life; (3) there is a correlation of materials and forces working toward an end; (4) there is a struggle to come to completion and, (5) there is a storing up and transmission of surplus energy.<sup>5</sup> In the first and last items he has made real contributions to social

<sup>1</sup> *Gedanken über die Sozialwissenschaft der Zukunft*, i, p. 27. Cf. *Pathologie Sociale*, Preface.

<sup>2</sup> *Gedanken*, ii, pp. viii f.

<sup>4</sup> *Gedanken*, i, pp. 56, 57.

<sup>3</sup> *Pathologie Sociale*, pp. 95 ff.

<sup>5</sup> *Ibid.*, pp. 57 f.

philosophy, especially in the last. He shows how this is especially characteristic of developed personality and how, in this respect, a society is not like a low form of organic life but like the highest. This process he terms social capitalization.<sup>1</sup> Society is further like a personality in that it has consciousness, reason and will.<sup>2</sup>

Another important contribution for our purpose is his distinction between a normal and diseased organism. This concept he applies by analogy to society and develops especially in his *La Pathologie Sociale*. Disease may affect society in any one of the three departments, — industry, justice, or politics, — and these social maladies correspond to three forms of nervous disease, that of industry to insanity, that of justice to delirium, that of politics to paralysis.<sup>3</sup> This last, however, can hardly be called a contribution to science of any kind. Ross scores Lilienfeld severely for such flimsy analogical reasoning.<sup>4</sup>

The discussion of social pathology leads our author to the question of social therapeutics which in places is equally fanciful and unscientific. In bringing out this phase of group life he introduces a note which finds little place in the systems of Comte or Spencer. We have now the concept of social mal-adaptation and the problem of adjustment.

Another analogy used by Lilienfeld which has had large use since, especially by pedagogical writers, is his bio-social law of recapitulation taken over from Haeckel, according to which the individual person recapitulates, in his development, the culture-periods of racial history.<sup>5</sup>

The analogical method has been used too frequently as a device to exploit some pet theory without painstaking endeavor to discover the forces at work in the process and formulate the laws of their operation. This has been true to a considerable extent as we shall have occasion to note later, with much of the reasoning of the biological school of sociologists who are apt to assume

<sup>1</sup> *Gedanken*, pp. 55 f.

<sup>3</sup> Barth, *op. cit.*, pp. 103-105.

<sup>2</sup> *Ibid.*, p. 61.

<sup>4</sup> *Foundations of Sociology*, p. 48.

<sup>5</sup> *Gedanken*, i, pp. 245 ff. "Die Stadien der menschlichen embryonalen Entwicklung eines jeden Individuums entsprechen der progressiven sozialen Entwicklung des ganzen Menschengeschlechts in seiner stufenweisen Ausbildung in Verlaufe der ganzen Geschichte der Menschheit" (*ibid.*, p. 247).

that a law that prevails, or is thought to prevail, in biological evolution, prevails in like manner in the evolution of a social group or civilization taken as a whole. The fact would seem to be rather that each phase of development has its characteristic marks and can be understood only in the light of an inductive study of the elements that make up its own life. Moreover, while a knowledge of higher phases of development can be applied with a good degree of certainty to lower phases, the reverse is true only within limits which need to be carefully defined.

GUILLAUME DE GREEF (1842- )

*Classification as a Method of Sociological Knowledge*

De Greef accepts Comte's hierarchy of the sciences, but greatly extends it to include the social sciences.<sup>1</sup> In addition to Spencer's principle of classification, — increasing complexity and dependence of parts, — he adds that of volitional activity or contractualism, which he holds to be "the distinguishing characteristic of society, both from the structural and the functional point of view," and defines as "their superior and special mode of adaptation and life."<sup>2</sup>

De Greef arranges the social elements in a hierarchy based on decreasing generality beginning with the economic and including in order, the industrial, genetic, artistic, scientific, moral, juridical, and political. Not only does this scale stand for the order of generality, but also represents their related order of influence on social progress and on each other. That is, the economic factor has great influence on social progress as a whole and on the political factor in particular, whereas the political factor has little influence on social progress and little on economic conditions.<sup>3</sup>

<sup>1</sup> *Am. Journ. Soc.*, vii; *Introduction à la Sociologie*, Preface.

<sup>2</sup> *Am. Journ. Soc.*, viii, p. 497. Cf. Barth, *op. cit.*, p. 69.

<sup>3</sup> This is a good example of the artificialities into which some are led. Such a harmonious cross-classification does not represent concrete life conditions. The fact is that government has more influence on the economic factor than it has on the religious, moral, or juridical, and, in fact, as Sumner has pointed out, the moral is most often changed by legislation that has aimed to bring about certain industrial changes. Cf. Barth, *ibid.*, p. 81; Small, *General Sociology*, pp. 68 ff.

The above hierarchy, too, according to our author, is based on increasing contractualism; i. e., in politics we have the highest degree of voluntary action, in economics, the least. De Greef thus made advance on the logical classification of Comte but made the mistake of thinking this represented the real objective order.<sup>1</sup>

Spencer, as we have seen, connects social with biological evolution without emphasizing any marked difference. With him social development is a part of the whole cosmic process which is a mechanical system and so affords no opportunity (or practically none) for rational control. While De Greef's position is in many respects the same,<sup>2</sup> yet his differentiating factor of volitional activity or contractualism, though perhaps merely logical, is yet important, for De Greef believed it represented some real objective distinction. It is closely related to Ward's concept of teleis and in proportion as his classification does represent reality it reveals degrees of active adaptation. But the same criticism applies here as in the case of Comte: a logical hierarchy is of no value for social science unless it represents objective distinctions and relations; but with neither of these writers are we made sure that this is the case,<sup>3</sup> and with De Greef we are very sure that it is positively false in some respects. As there are different degrees of adaptation,<sup>4</sup> or better, of mal-adaptation, the important thing

<sup>1</sup> *Op. cit.*, i, p. 159. Barth holds that logical classification may represent the temporal evolution of an object as a biological organism, but that it does not represent necessarily the evolution of a science or of a social institution. He shows that as propagation co-exists with struggle for existence, so love is as early as economic endeavor, and that the industrialism of primitive people is no more general than their religious thoughts and acts, *op. cit.*, p. 87.

<sup>2</sup> *Ibid.*, i, p. 140.

<sup>3</sup> On this point Small justly remarks: "His claim with reference to the hierarchial order of phenomena so arranged must stand or fall as a result of specific investigation of the activities and sub-activities distinguished in the schedule." *General Sociology*, p. 72. Cf. Barth, pp. 88 f.

<sup>4</sup> "There is a wide interval between the highest and lowest degrees of completeness of living that are compatible with maintenance of life. Hence the wicked flourish. Vice is but slowly eliminated because mankind has so many other qualities, besides the bad ones, which enable it to subsist and achieve progress in spite of them, that natural selection, — which always works through death, — cannot come into play." John Fiske, *Cosmic Philosophy*, ii, p. 98.



to know is the cause of the mal-adaptation and the best way to secure adjustment, and for this De Greef's logical scheme would not seem to be of much service.

De Greef makes advance over both Comte and Spencer, also, in that he gives clearer content to the concept of society, holding that humanity is a social organism only at best potentially, and that the true social aggregates are the androgynous couple, the family, tribe, etc.,<sup>1</sup> moreover that the distinguishing feature of the social organism is a certain *felt* "togetherness" whether it be merely automatic and reflexive or thought out.<sup>2</sup>

<sup>1</sup> *Op. cit.*, p 71.

<sup>2</sup> *Op. cit.*, p. 131.



PART II

PASSIVE PHYSICAL AND PHYSIO-  
SOCIAL ADAPTATION



## CHAPTER IV

### BIOLOGICAL EVOLUTION

HAVING surveyed in outline the social theories of Comte and Spencer with special reference to their bearing on the doctrine of adaptation, and having reviewed the various methods in use in social science and social philosophy and considered their bearing on our subject, pointing out some of the dangers lurking in the use of the classifying, analogical and statistical methods, our next problem is to study the development of the doctrine of adaptation by those who have endeavored to explain evolution in terms of the influence of the environment on the organism or social group.

The environment may affect the organism in three different ways: (1) by direct action, producing molecular, chemical or functional changes as in pigmentation and acclimatization; (2) by affording favorable opportunity for growth and functional variation, or the reverse, as in change of habitat resulting in increase or decrease of food, or (3) by furnishing conditions favorable to struggle and selection.

The first view, advocated by Buffon and Erasmus Darwin,<sup>1</sup> was eclipsed for a long time under the influence of the theory of natural selection but has been upheld firmly by Viet, Scott Elliott, W. H. Dall and others, and still more recently by the advocates of the theory of geographical isolation as the most important factor in species formation.<sup>2</sup>

The direct influence of environment on the organism is well illustrated by the words of Dall though in somewhat exaggerated terms: "The environment stands in a relation to the individual such as the hammer and anvil bear to the blacksmith's hot iron. The organism suffers during its entire existence a continuous

<sup>1</sup> Packard, *Lamarck*, pp. 203, 218.

<sup>2</sup> Kellogg, *Darwinism To-day*, ch. IX.

series of mechanical impacts, none the less real because invisible, or disguised by the fact that some of them are precipitated by voluntary effort of the individual itself.”<sup>1</sup>

The influence on the organism of such environmental forces as food and climate has never been seriously questioned. The mooted points are such as these: (1) the inheritance in any degree of characters thus acquired, and if so, the method; (2) the presence and potency in the organism of a vital, directive force; (3) the character of the variations whether continuous or discontinuous; and (4) the process by which variations come to have such qualitative difference as to give rise to new species. The most vital point in the controversy today, especially among the followers of Weismann, is as to whether or not any environmental influence can affect heredity, working either through the blood or through the central nervous system, and if so, what such influences are and how the effect is produced.

In the development of the doctrine of adaptation in theories of biological evolution, five names stand out with such prominence as to demand special consideration: Lamarck, Charles Darwin, Weismann, De Vries and Mendel.

#### JEAN BAPTISTE DE LAMARCK (1744-1829)

##### *Use-Inheritance*

Pemberton in his *Path of Evolution* thus characterizes the work of Lamarck: —

He rendered to mankind the eminent service of arousing attention to the probability that all change in the organic as well as in the inorganic world, was the result of law and not miraculous interposition. His theories of the origin of species were, that the organs of the body were modified by the desires and will of the individual in response to external condition. The changes thus induced would be transmitted to their offspring, subject, moreover, to like changes from new conditions so that, if illimitable time was granted, it would account for the formation of the highest order of animals from the lowest organisms. In accordance with this doctrine he held that man himself was derived from the species next below him, the anthropoid apes.<sup>2</sup>

<sup>1</sup> Pemberton, *Path of Evolution*, p. 294.

<sup>2</sup> *Op. cit.*, p. 294.

The four laws of organic evolution as formulated by Lamarck in his latest work are as follows: —

First law: Life, by its proper forces, continually tends to increase the volume of every body which possesses it, and to increase the size of its parts, up to a limit which it brings about.

Second law: The production of a new organ in an animal body results from the supervention of a new want (*besoin*) which continues to make itself felt, and of a new movement which this want gives rise to and maintains.

Third law: The development of organs and their power of action are constantly in ratio to the employment of these organs.

Fourth law: Everything which has been acquired, impressed upon, or changed in the organization of individuals, during the course of their life is preserved by generation and transmitted to the new individuals which have descended from those which have undergone these changes.<sup>1</sup>

These four laws may be summarized briefly into these two principles: (1) the active response of an organism by way of variation to a felt need of adjustment to its environment, and (2) use and disuse inheritance. The first issues easily into the theory of an active life-principle or “bathmic force” as formulated by Nägeli, Ratzenhofer and Ward, while the second has been the chief point of contention among biologists since Weismann’s experiments on mice.

After pointing out the function of instinct in the lower orders Lamarck differentiates the higher in a way to lay the biological foundation of the concept of active adaptation. “It is not the same in animals which, besides a nervous system, have a brain, and which make comparisons, judgments, thoughts, etc. These same animals control more or less their power of action according to the degree of perfection of their brain; and although they are strongly subjected to the results of their habits, which have modi-

<sup>1</sup> Packard, *Lamarck*, p. 346. “Every want felt produces an emotion in the inner feeling of the individual which experiences it; and from this emotion of the feeling in question arises the force which gives origin to the movement of the parts which are placed in activity. . . . Thus, in the animals which possess the power of acting, — the force productive of movements and actions, — the inner feeling, which on each occasion originates this force, being excited by some need, places in action the power of force in question; excites the movement of displacement in the subtle fluid of the nerves which the ancients called the *animal spirits*; directs this fluid toward that of its organs which any want impels to action; finally, makes this same fluid flow back into its habitual reservoirs when the needs no longer require the organ to act.” — *Ibid.*, p. 330.

fied their structure, they enjoy more or less freedom of the will, can choose, and can vary their acts, or at least some of them.”<sup>1</sup> That is, if man’s mode of existence calls for stronger muscles in any part of his body, he can, by taking thought, exercise and thus develop those parts. In this sense the organism is modified by a consciousness of need and an act of will, although the process of adaptation is in strict accordance with law.

### CHARLES DARWIN (1809-1882)

#### *Natural Selection*

Charles Darwin was born at Shrewsbury, England, of an ancestry that by “nature” or “nurture” had much to do with his future life-work. His grandfather, Erasmus, in his *Zoonomia* published in 1794, had laid down ten principles bearing on evolution, many of which became famous later through Lamarck and Charles Darwin, though they were worked out independently by the former and to a considerable extent by the latter.<sup>2</sup> His father Robert was a most acute observer of nature. From him came caution and conservatism. It is significant, too, that his cousin was the Francis Galton who was the founder of the science of eugenics.

In formal education Darwin was not a success. Turning aside from medicine which he studied at Edinburgh, and from theology which he studied at Cambridge, he closed his academic studies with his chief asset the scientific inspiration which he received from the botanist Professor Henslow, and the geologist, Professor Sedgwick. The two books to which he was most indebted were Lyell’s *Principles of Geology* and *Malthus on Population*, — the two books which profoundly influenced Spencer also. The most potent factor in Darwin’s education, apart from the influence of these teachers, was the experience he had as naturalist on the “Beagle” which made a tour of the world for scientific purposes in 1831-36.

With broken health, his great work, *The Origin of Species*, was published in 1859 after twenty-one years of labor to demonstrate

<sup>1</sup> Packard, *Lamarck*, p. 331.

<sup>2</sup> *Ibid.*, pp. 230 f.



the truth of the hypothesis with which he began;<sup>1</sup> and it was given the world then only because A. R. Wallace had come to similar conclusions working independently, though for a much shorter time.

Darwin started with the general theory of evolution based on a recognition of the influence of heredity and environment, with Malthus' doctrine of "teeming nature" and struggle for existence; with Lamarck's law of transmission of acquired characters; and with the observed facts of variation and improvement under domestication. His problem was: "Can nature, with long enough time, do what man in a short time is able to accomplish by use of reason and choice?" The hypothesis of natural selection with the correlative doctrine of sexual selection was the outcome of his thought and years of most painstaking observation.

There are five links in the chain of this theory of the origin of species: (1) prodigality of nature; (2) struggle for existence; (3) variation; (4) survival of the fittest, and (5) heredity.<sup>2</sup> Other factors recognized but not emphasized by Darwin, such as "geographical isolation" have since come into prominence and one, transmission of acquired characters, taken over from Lamarck, has been questioned with ever increasing unanimity since Weismann's experiments.

*Prodigality of Nature and Struggle for Existence.*—These two links are so interrelated as to call for consideration together, as was done by Darwin. "A struggle for existence," he says, "inevitably follows from the high rate at which all organic beings tend to increase."<sup>3</sup> The term "struggle for existence" is used in a large and metaphorical sense, as Darwin takes pains to explain, and includes "dependence of one being on another, and . . . not only the life of the individual, but success in leaving progeny."<sup>4</sup> This doctrine is that of "Malthus applied with manifold force to the whole animal and vegetable kingdoms; for in this case there can be no artificial increase of food, and no prudential restraint upon marriage. . . . There is no exception to the rule that every

<sup>1</sup> *Fifty Years of Darwinism*, pp. 17 ff.

<sup>2</sup> Conn, *The Method of Evolution*, pp. 19, 20. Wallace, *Darwinism*, ch. I.

<sup>3</sup> *Origin of Species*, London, 1872, p. 50.

<sup>4</sup> *Ibid.*, p. 50.

organic being naturally increases at so high a rate that, if not destroyed, the earth would soon be covered by the progeny of a single pair." Darwin gives many instances of the prodigality of nature and these have been supplemented by contributions from more recent exponents of "natural selection."<sup>1</sup>

He considers various checks to the increase of members of a species including enemies, lack of food supply and climate and shows the complex relations of all animals and plants to each other in the struggle for existence, concluding that "battle within battle must be continually recurring with varying success."<sup>2</sup>

This prodigality and struggle for existence, according to the author under consideration, is just the condition most favorable for progress by means of natural selection, for in this struggle those individuals which by slight favorable variations are best adapted to the conditions of life will survive whereas the least adapted will perish. As to the working of natural selection, Darwin says: "Let the endless number of slight variations and individual differences occurring in our domestic productions, and, in a lesser degree, in those under nature, be borne in mind; as well as the strength of the hereditary tendency. . . . Can it then be thought improbable, seeing that variations useful to man have undoubtedly occurred, that variations useful in some way to each being in the great and complex battle of life, should occur in the course of many successive generations? If such do occur, can we doubt (remembering how many more individuals are born than can possibly survive) that individuals having any advantage, however slight, over others, would have the best chance of surviving and of procreating their kind? On the other hand, we may feel sure that any variation in the least degree injurious would be rigidly destroyed." He goes on to say that "variations neither useful nor injurious would not be affected by natural selection, and would be left either a fluctuating element . . . or would ultimately become fixed, owing to the nature of the organism and the nature of the conditions."<sup>3</sup>

<sup>1</sup> Wallace, *op. cit.*, pp. 25 f.; Conn, *op. cit.*, pp. 52 ff.; Morgan, *Evolution and Adaptation*, p. III.

<sup>2</sup> *Origin of Species*, p. 57.

<sup>3</sup> *Ibid.*, pp. 62, 63.

Darwin further grants that multitudes of eggs and organisms are destroyed by accidental causes in which case the quality of the stock would not be affected.<sup>1</sup>

*Variation and Survival.* — The theory of natural selection was suggested and built up to a considerable extent on principles long observed in artificial breeding. The fact of considerable variation in each new generation had been observed for thousands of years, and use made of the principle of "selection" to secure desirable traits. Darwin accepted the well-known facts of variation without attempting to explain their efficient cause or causes. He recognized two kinds, the indefinite and the definite.

The direct action of changed conditions leads to definite or indefinite results. In the latter case, the organism seems to become plastic, and we have much fluctuating variability. In the former case the nature of the organism is such that it yields readily, when subjected to certain conditions, and all, or nearly all, the individuals become modified in the same way.

It is very difficult to decide how far changed conditions, such as of climate, food, etc., have acted in a definite manner. There is reason to believe that in the course of time the effects have been greater than can be proved by clear evidence. . . . When a variation is of the slightest use to any being, we cannot tell how much to attribute to the accumulative action of natural selection, and how much to the definite action of the conditions of life.<sup>2</sup>

In response to an objection that a single variation would soon be swamped, our author admits the force of the point and suggests an explanation that is very close to the theory of "organic selection" formulated later by Lloyd Morgan, Osborn and Baldwin. "It should not . . . be overlooked," he says, "that certain rather strongly marked variations, which no one would rank as mere individual differences, frequently recur owing to a similar organization being similarly acted on, — of which fact numerous instances could be given with our domestic productions. In such cases, if the varying individual did not actually transmit to its offspring its newly acquired character, it would undoubtedly transmit to them, as long as the existing conditions remained the same, a still stronger tendency to vary in the same manner."<sup>3</sup> T. H. Morgan thinks this and what immediately follows invalidates much that had been claimed previously for natural

<sup>1</sup> *Origin of Species*, p. 68.

<sup>2</sup> *Ibid.*, p. 106. Cf. p. 170.

<sup>3</sup> *Ibid.*, p. 72.

selection, for Darwin continues: "There can also be little doubt that the tendency to vary in the same manner has often been so strong that all the individuals of the same species have been similarly modified without the aid of any form of selection."

As to conditions favorable for the production of new forms through natural selection, Darwin mentions a large and diverse area, numbers of individuals in the species, intercrossing (especially among hermaphrodites) and isolation.<sup>1</sup> Diversification of structure is considered an adaptive quality under some circumstances and is discussed at length,<sup>2</sup> and origin of species is accounted for as the cumulative result of ever increasing diversifications which in time become fixed.<sup>3</sup>

In considering the degree to which organization tends to advance, Darwin discusses the question of standards of judging advancement and accepts that of Von Baer, namely, "the amount of differentiation of the parts of the same organic being, (in the adult state, Darwin adds) . . . and their specialization for different functions . . . or the completeness of the division of physiological labor."<sup>4</sup>

Not only does natural selection lead to the origin of new species, but also to the extinction of intermediate forms.<sup>5</sup> "Use and disuse of organs" is linked with natural selection, so also "acclimatization," "correlated variation," and "compensation and economy of growth";<sup>6</sup> then follows a frank discussion of the difficulties in the way of accepting his theory. "Some of them," he says, "are so serious that to this day I can hardly reflect on them without being in some degree staggered."<sup>7</sup>

<sup>1</sup> *Origin of Species*, pp. 81 ff. This last element, first stressed by Wagner, was given great prominence by Romanes and more recently by David Starr Jordan. "In the principle of isolation," says Romanes, "we have a principle so fundamental and so universal, that even the great principle of natural selection lies less deep, and pervades a region of smaller extent. Equalled only in its importance by the two basal principles of heredity and variation, this principle of isolation constitutes the third pillar of a tripod on which is reared the whole superstructure of organic evolution." — *Darwin and after Darwin*, ii, p. 2.

<sup>2</sup> *Origin of Species*, pp. 86 ff.

<sup>5</sup> *Ibid.*, pp. 59, 93, 134 f.

<sup>3</sup> *Ibid.*, pp. 90 ff.

<sup>6</sup> *Ibid.*, ch. V.

<sup>4</sup> *Ibid.*, p. 97.

<sup>7</sup> *Ibid.*, p. 133.

The first difficulty is concerning "the absence or rarity of transitional varieties," and his answer is: "As natural selection acts solely by the preservation of profitable modifications, each new form will tend in a fully-stocked country to take the place of, and finally to exterminate, its own less improved parent-form and other less favored forms with which it comes into competition."<sup>1</sup> In discussing the difficulty of explaining neuter insects, Darwin formulates the doctrine of selection on the basis of utility to the species rather than to the individual.<sup>2</sup>

In reply to criticism by Mr. Mivart, Darwin takes issue with all who believe in mutations, appealing as usual to experience under domestication.<sup>3</sup>

Instincts are discussed at length and their origin explained in the same way as other useful characters, — by natural selection.<sup>4</sup>

We find further contributions to our doctrine of adaptation in Darwin's *Descent of Man* though here he was preceded by other writers. In this work we are shown how the various mental qualities so highly developed in man have descended or "ascended" from rudiments to be found in the lower orders.<sup>5</sup> Emotion, imitation, attention, memory, imagination, reason, the use of tools, even language are thus evolved. All of these, — with many others such as self-consciousness, individuality, abstraction, general ideas, sense of beauty, religion, — are the

<sup>1</sup> *Origin of Species*, p. 134.

<sup>2</sup> *Ibid.*, pp. 230 f.

<sup>3</sup> *Ibid.*, pp. 202 f. Recent experiments by De Vries, Bateson and others, however, indicate to their satisfaction that nature does take leaps, "Natura facit saltum." Cf. Walter, *Genetics*, chs. IV, VII, and VIII.

<sup>4</sup> *Ibid.*, ch. VIII. Professor T. H. Morgan takes issue with his conclusions concerning the development of such instincts as that of slave-holding among certain species of ants. "We must not forget," says Professor Morgan, "that it is not enough to show that a particular habit might be useful to a species, but it should also be shown that it is of sufficient importance, at every stage of its evolution, to give a decisive advantage in the 'struggle for existence.' For unless a life and death struggle takes place between the different colonies, natural selection is powerless to bring about its supposed results. And who will be bold enough to affirm that the presence of slaves in a nest will give victory to that colony in competition with its neighbors? Has the history of mankind taught us that slave-making countries have exterminated countries without slaves?" His conclusion is that the instinct was a mutation and that the species practising it survived because it was not so disuseful as to lead to extermination.

<sup>5</sup> Articulate language, however, is peculiar to man. *Descent of Man*, p. 52.

outcome of the process of natural selection. In this discussion Darwin pays tribute to Herbert Spencer and agrees with his doctrine of use-inheritance taken from Lamarck. Man's development, he holds, is in every case homologous with that of the lower orders.<sup>1</sup>

In discussing the rate of increase in population our author follows Malthus rather than Spencer, holding that "there is reason to suspect . . . that the reproductive power is actually less in barbarous than in civilized races."<sup>2</sup> Malthus is criticized for not giving sufficient emphasis to infanticide as a check among primitive people.

Passive adaptation which gave man the prehensile thumb, erect posture and added brain capacity, is shown to have been the one supreme factor in making possible those later differentiations which are the crowning glory of the human race.<sup>3</sup>

In conclusion, he says: —

As all animals tend to multiply beyond their means of subsistence, so it must have been with the progenitors of man and this will inevitably have led to a struggle for existence and to natural selection. This latter process will have been greatly aided by the inherited effects of the increased use of parts; these two processes incessantly reacting on each other. It appears, also, as we shall hereafter see, that various unimportant characters have been acquired by man through sexual selection. An unexplained residuum of change, perhaps a large one, must be left to the assumed uniform action of those unknown agencies which occasionally induce strongly-marked and abrupt deviations of structure in our domestic productions.

With strictly social animals, natural selection sometimes acts indirectly on the individual, through the preservation of variations which are beneficial only to the community. A community, including a large number of well-endowed individuals, increases in number and is victorious over other and less well-endowed communities; although each separate member may gain no advantage over the other members of the same community.<sup>4</sup>

In Chapter V of the *Descent of Man* we find developed the doctrine phrased in this paper as active material adaptation. Following Wallace our author shows how important was the

<sup>1</sup> Ch. IV. It is noteworthy that both Wallace and Weismann differed from Darwin as to the explanation of the evolution of mental and moral faculties by natural selection. Wallace, *Darwinism*, p. 461.

<sup>2</sup> *Descent of Man*, p. 127.

<sup>3</sup> *Ibid.*, ch. IV.

<sup>4</sup> *Ibid.*, p. 149.

change in the evolutionary process when natural selection turned from the development of the organism to the development of intellectual power, "for man is enabled through his mental faculties 'to keep with an unchanged body in harmony with the changed universe.'" He invents weapons, tools, and various stratagems, by which he procures food and defends himself. When he migrates into a colder climate he uses clothes, builds sheds, and makes fires.<sup>1</sup> What a contrast this to that of the lower animals, who "must have their bodily structure modified in order to survive under greatly changed conditions."

The development of intelligence and sagacity in earliest times enabled the tribes whose members were best endowed to supplant the other tribes, even as today in various parts of the world.<sup>2</sup> With the development of men in society, progress became more rapid through imitation, reason and experience.<sup>3</sup> Likewise were developed sympathy, fidelity, courage and obedience to authority. "A tribe possessing the above qualities in a high degree would spread and be victorious over the other tribes; but in the course of time it would, judging from all past history, be in its turn overcome by some other and still more highly-endowed tribe. Thus the social and moral qualities would tend slowly to advance and be diffused throughout the world."<sup>4</sup>

From experience the value of co-operation was learned, habits formed and sympathy developed, which after many generations became fastened upon the organism as an instinct.<sup>5</sup> Thus, too, originated other social virtues such as the praise and blame of fellow-men, love of approbation and dread of infamy, and remorse at the consciousness of failure in the performance of duty. Later the self-regarding virtues developed, such as temperance, chastity, etc., based on experience of the results of conduct.<sup>6</sup>

As Darwin's argument concerning the working of the law of natural selection among civilized nations is built so largely on the labors of such investigators as W. R. Greg and Francis Galton, we will pass over the subject for the present and turn to another

<sup>1</sup> *Descent of Man*, p. 152.

<sup>2</sup> *Ibid.*, p. 154.

<sup>3</sup> *Ibid.*, p. 155.

<sup>4</sup> *Ibid.*, p. 156.

<sup>5</sup> *Ibid.*, p. 157.

<sup>6</sup> *Ibid.*, p. 158.

line of argument which will not be duplicated in a later part of this discussion.

Concerning the causes which lead to the extinction of races of man, we are told that "unfavorable physical conditions appear to have had but little effect," but that "extinction follows chiefly from the competition of tribe with tribe, and race with race"; also, that "when civilized nations come into contact with barbarous, the struggle is short, except where a deadly climate gives aid to the native race." Among the specific causes for this extermination, new diseases and vices are mentioned as being among the most potent.<sup>1</sup>

Next to natural selection, the doctrine of sexual selection is the great original contribution of Darwin, although in a sense it may be considered but a modification of the former. The problem is to account for the development of secondary sexual differences, among other things for the fact that in most species of birds the males are more conspicuously beautiful than the females. In contrast to natural selection which has to do with the results of a life and death struggle for existence, sexual selection has to do merely with the process and results of mating whereby certain qualities are selected and transmitted. The more vigorous males or those better weaponed, secure possession of the desired females leaving the weaker males to mate with the females that are left over. The supposition is that the more vigorous pairs will leave the most numerous offspring. Or, again, the females are supposed to exercise choice and select the more brilliant or active males, with the same result.<sup>2</sup> Such selection is most easily secured when the males largely exceed the females in number, otherwise resort is made to the hypothesis that the more vigorous are ready to mate first either physiologically, or by virtue of reaching first the breeding place, and so rear a more numerous progeny.<sup>3</sup>

<sup>1</sup> *Descent of Man*, pp. 229 f.

<sup>2</sup> *Ibid.*, chs. VIII and XIII.

<sup>3</sup> Professor T. H. Morgan has formulated twenty objections to this doctrine, among others that "there is no evidence that the more precocious females would rear a larger number of offspring than the more normal females, or even those that breed somewhat later." *Evolution and Adaptation*, ch. VI; cf. Kellogg, *op. cit.*, p. 118.



It is noteworthy in this connection that Darwin and Wallace had diametrically opposite theories as to the cause of the more brilliant plumage of male birds. "According to Darwin, the gayness of male birds is due to selection on the part of the females; according to Wallace, the soberness of female birds is due to natural selection, which has eliminated those which persisted to the death in being gay."<sup>1</sup>

*Heredity.* The fifth and last link to be considered does not yield to Darwin added fame. A follower of Lamarck in the belief that acquired characters were inherited, he was led to make use of this refuge when hard pressed by his opponents. His constructive theory, that of pangenesis, — given to the world against the advice of Huxley,<sup>2</sup> — was so completely disproved by Weismann as to receive scant reference today, though here, too, he was a prophet and the hope expressed to Sir Joseph Hooker has been fulfilled: "I feel *sure* that if pangenesis is stillborn it will, thank God, at some future time reappear, begotten by some other father and christened by some other name."<sup>3</sup> Cytology has taken up his task and some who have received his mantle are striving earnestly to discover the secret hidden from his, and up to the present, from all human eyes, — the mystery of heredity. De Vries has made some use of Darwin's hypothesis in his theory of "intracellular pangenesis," so too Weismann in his theory of "determinants," but laboratory experiments have not as yet added conviction to assumption.

The transmission of acquired characters in the sense used by Lamarck, Spencer and Darwin has been all but disproven, though as we shall see later there is proof of the influence of ontogenetic variations on the offspring, and some ground for believing that habit and environment may furnish conditions favorable for modification of the germ plasm.

In concluding our discussion of Darwin and the bearing of his theory of natural selection on the problem of this study, first place must be given to the new spirit infused into biological and social science by the publication of his *Origin of Species*. With

<sup>1</sup> *The Evolution of Sex*, Geddes and Thomson, p. 10; Wallace, *Darwinism*, pp. 274 f. Cf Morgan, cited above pp. 213 ff.

<sup>2</sup> Cf *Fifty Years of Darwinism*, p. 93.

<sup>3</sup> *Ibid.*, p. 94.

good reason has he been called the liberator of the human mind and spirit. Patient, long-continued investigation to discover the cause and laws of variation is now the *sine qua non* of success in every science. His catholic spirit, generous appreciation of the discoveries of others together with a humble estimate of his own merit form a rare combination in one who is generally estimated as the most influential thinker of the nineteenth century. The five links in his chain of causes leading to the origin of species stand today, though some have been interpreted differently, and causes minimized by him have been raised to rank with that of his great theory. Especially is this true concerning the factor of geographical isolation.

The fittest to survive, in Darwin's thought, are those best adapted to their environment. Spontaneous variations of use in the struggle for existence have been preserved and transmitted by heredity while variations disuseful have been eliminated. Not only is adaptation emphasized by him but adaptability, that is, power in the organism to adapt itself to a changing environment. We have brought to our attention also the fact that the variations need not always be useful to the individual providing they are useful to the species in its contest with other species. Connection is made between passive and active adaptation and the principle of struggle and survival applied to the development of the higher human faculties and the evolution of races. Natural selection is supplemented by sexual selection to account for secondary sexual differences.

We must pass now to the contributions of some other biologists who have supplemented and corrected the work of their master.

AUGUST WEISMANN (1834- )

*Continuity of the Germ Plasm*

August Weismann the "Sage of Freiburg" is especially worthy of consideration in our discussion as his investigations and teachings mark a turning-point in biological and to a certain extent in sociological theory, for the doctrine of natural selection was somewhat on the wane when he began to write but with him it

has taken on new life and in his earlier writings and with most of his disciples it has become the "Allmacht" in the explanation of the formation of new species.

Weismann's contributions to biology are thus summarized by Kellogg:

His careful investigation and illumination of the vexed question of the inheritance of acquired characters, his definite exposition of that point of view which distinguishes sharply in the individual between the germ-plasm (that particular protoplasm in the body from which the germ-cells, eventually new individuals, arise) and the soma-plasm (that which develops into, or gives rise to, the rest of the body), his development of the interesting and suggestive combinations of fact and theory designated by the phrase names "continuity of the germ-plasm" and "immortality of the Infusoria," — these products of his investigating and philosophizing mind prove him one of the ablest of modern biological scholars.<sup>1</sup>

Of almost equal importance with the above for sociology is his emphasis on the species as the unit in the struggle for existence, for from this point of view sympathy, mutual aid and all forms of co-operation that make for group strength are seen to be of adaptive value.

Weismann's theory of "germinal selection" is also worthy of note for although not widely accepted today we find in it an application of the doctrine of adaptation to the determinants — the theoretical sub-divisions of the germ-cell. Weismann holds that these determinants compete for the possession of food and that the successful dominate in the organism that is to be.<sup>2</sup>

Weismann's influence on social theory will be noted in succeeding chapters; here it will suffice to bring out his teaching concerning the continuity of the germ-plasm for the wide-spread acceptance of this has led to the corresponding disbelief in the inheritance of acquired characters as taught by Lamarck and Spencer, and has been a most potent factor in the modern eugenics movement. Weismann's statement of the theory is as follows:

Heredity depends upon the fact that a small portion of the effective substance of the germ, the germ-plasm, remains unchanged during the development of the ovum into an organism, and this part of the germ-plasm serves as a foundation from which the germ-cells of the new organism are produced. There is therefore continuity of the germ-plasm from one generation to

<sup>1</sup> *Darwinism To-day*, p. 188.

<sup>2</sup> For explanation of germinal selection, see Kellogg, *op. cit.*, pp. 195 f.

another. One might represent the germ-plasm by the metaphor of a long creeping root-stock from which plants arise at intervals, these latter representing the individuals of successive generations.<sup>1</sup>

Heredity being thus explained, variation is held to be due to the union of diverse sex cells<sup>2</sup> and possibly to katabolic influences from the environment that somehow affect the germ-plasm.<sup>3</sup>

HUGO DE VRIES (1848- )

*Mutations*

Three quotations at the very beginning of De Vries' *Species and Varieties* are suggestive of the relation between his work and that of Lamarck and Darwin. "The origin of species is a natural phenomenon," Lamarck; "The origin of species is an object of inquiry," Darwin; "The origin of species is an object of experimental investigation," — this is the thesis of De Vries, and to his observations and experiments, according to Sir Arthur Thomson, the world is indebted for the establishment upon a solid basis of the theory of evolution by mutation.

A further relation between this theory and that of Darwin is brought out in the closing words of the book referred to: "Mutation explains the arrival of the fittest but natural selection the survival of the fittest." That is, De Vries does not deny the potency of natural selection, as some have asserted, but contends that it is insufficient as a theory of biological evolution for it takes no account of the origin of change. His chief contention with the Darwinians is that natural selection operates to preserve adaptive mutations rather than mere fluctuations.<sup>4</sup> The theory in question is thus explained by Thomson:

The general idea is that novel characters may suddenly appear, as it were, full-fledged, with considerable perfectness from the moment of their emergence, and without intergrades linking them to the parents. Furthermore.

<sup>1</sup> *Essays upon Heredity*, p. 266; cf. pp. 184 f. For further explanation and illustration, see Walter, *Genetics*, pp. 10-13.

<sup>2</sup> *Essays upon Heredity*, pp. 269 f.

<sup>3</sup> Weismann laid all stress on the former but in his later writings admitted the latter, and recent experiments have demonstrated the certainty of such source of variation though the range seems very limited. See *infra*, pp. 73 f.

<sup>4</sup> *Species and Varieties, their Origin and Mutation*, Introduction. Cf. Kellogg, *op. cit.*, pp. 337 ff.

the novel character of the mutant, if we may use the word, is independently heritable and does not blend; it can be grafted intact onto another stock, or it can be dropped out as such. Again, mutations are what may be called qualitative, as contrasted with fluctuations which are quantitative.<sup>1</sup>

Having established the principle of mutation or discontinuous variation, which Darwin denied, De Vries raises several questions which have not as yet been answered: Is mutability a temporary or permanent condition? If temporary what is its cause and how is the quality lost? How may mutations be induced or controlled?<sup>2</sup> By way of answer he suggests several working hypotheses: Mutability may be a periodic phenomenon; It may be permanent in the main line of development with loss of mutability in lines branching from the main trunk of the genealogic tree; One primary mutation giving rise to one or more unit characters, initiates a multitude of minor changes.<sup>3</sup> He thinks that besides these periodic seasons of mutation there are stray mutations that are potent also in the evolutionary process.

Our author discusses at length the possibilities and limitations of artificial selection,<sup>4</sup> shows how inconstant are races improved thus and how prone they are to revert to the species-type,<sup>5</sup> also how uncertain is selection based on visible qualities,<sup>6</sup> holding that the study of pedigree is of first importance.

## JOHANN GREGOR MENDEL (1822-1884)

### *Independent Unit Characters*

Although Mendel's great work antedated both that of Weismann and De Vries, it was entirely lost to the scientific world for nearly forty years and not brought to light till 1900 when within a few months De Vries, Correns and Tschermak working independently published papers setting forth the substance of his discoveries.

<sup>1</sup> *Darwinism and Human Life*, p. 107.      <sup>2</sup> *Species and Varieties*, pp. 690 f.

<sup>3</sup> "At the beginning of each series of analogous mutations there must have been one greater and more intrinsic mutation, which opened the possibility to all its successors. This was the origination of the new character itself, and it is easily seen that this incipient change is to be considered as the real one. All others are only its visible expressions," *ibid.*, p. 703.

<sup>4</sup> *Ibid.*, pp. 805 f.

<sup>5</sup> *Ibid.*, pp. 770 f.

<sup>6</sup> *Ibid.*, pp. 810 f.

The so-called Mendelian law, the outgrowth of years of experiment by Mendel in crossing garden peas of different varieties, and verified since by hundreds of experiments on various plants and animals by many botanists and zoölogists, is thus stated and illustrated by Professor Walter: <sup>1</sup>

When parents that are unlike with respect to any character are crossed, the progeny of the first generation will apparently be like one of the parents with respect to the character in question. The parent which impresses its character upon the offspring in this manner is called the *dominant*. When, however, the hybrid offspring of this first generation are in turn crossed with each other, they will produce a mixed progeny, 25 per cent of which will be like the dominant grandparent, 25 per cent like the other grandparent, and 50 per cent like the parents resembling the dominant grandparent.

The law is represented by the following figure which shows that in monohybrids the dominant character comes to the surface in the second generation in three out of four of the offspring, one of the three, however, being of pure breed, the other two being hybrids.

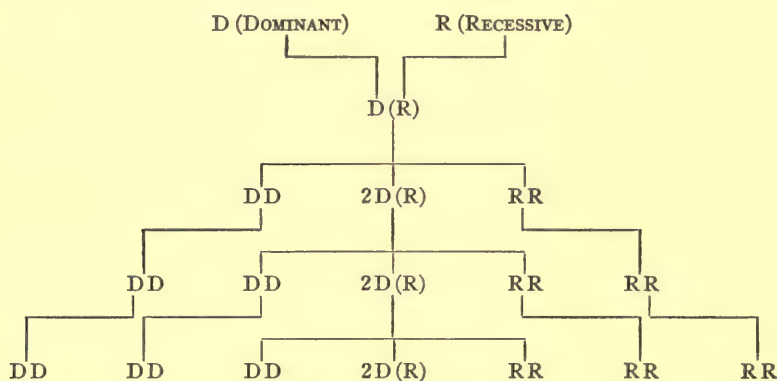

There are three principles involved in this law: (1) The existence of *independent unit characters*, (2) *dominance*, in cases where the parents differ in a unit character, and (3) *segregation* of the units contributed by the respective parents, this segregation being found among the gametes formed by the offspring.<sup>2</sup>

<sup>1</sup> *Genetics*, pp. 123 f.

<sup>2</sup> Castle, *Heredity*, p. 38; cf. Walter, *op. cit.*, pp. 144, 145.

The knowledge and use of the Mendelian law by animal breeders and horticulturists during the past few years have shown its great importance to man in the process of active material adaptation, and its present use in studies of defectiveness has demonstrated its value in eugenics which comes under the division of active social adaptation.

Before summing up the contributions of biology to sociology and to the subject of this book in particular it may not be amiss to consider briefly the position of biologists today on some of the fundamental questions brought out in our survey of the theories of Darwin and his successors. For this purpose the *Centennial Addresses in Honor of Charles Darwin* before the American Association for the Advancement of Science, should furnish impartial material.

That inborn variation and natural selection alone are sufficient was questioned by J. M. Coulter of the University of Chicago from the side of botany. David Starr Jordan of Leland Stanford emphasized isolation as a factor of equal importance with natural selection. E. B. Wilson of Columbia showed that experiments had proven the possibility of the transmission of ontogenetic variations and gave assent to the theory of metabolism through chemical action. "Experiment," he said, "has established the fact that certain forms of development are thus controlled by substances, the 'hormones,' that may be extracted from the cells that produce them, and upon injection into the body call forth their characteristic results. Such an effect, for instance, is the development of the cock's comb in the hen upon injection of testis-extract and its recession to the characteristic female condition upon cessation of the injections."<sup>1</sup> Professor Wilson made another statement of great suggestive value in its bearing on social progress: "We must not forget that some of the most acute and thoughtful of naturalists have in recent years expressed the conviction that the ultimate control of development is not to be sought in the physico-chemical properties of the germ cells, but in an indwelling 'entelechy' or 'élan de la vie,' a power of

<sup>1</sup> *Fifty Years of Darwinism*, pp. 106, 107.

unknown nature, that may, in the last analysis, be psychical in nature.”<sup>1</sup> Though not a neo-Lamarckian, Professor Wilson makes room for environmental influences to affect the germ plasm and so influence heredity. “Though we may not fully understand the manner in which the germ cells are modified, there is no inherent improbability or difficulty in the conception that such modifications will produce blastogenic variations or mutations that are inherited, permanently or temporarily. We can readily understand that the constitutional effects of temperature, food, moisture, and similar general agencies of the environment may manifest themselves in definite changes that reappear in following generations because the germ cells have been directly affected in the same way as the somatic cells.”

D. T. MacDougal of the Carnegie Institution of Washington took a position very like that of Wilson, holding that “the securest foundation is laid for the conclusion that well-defined correlations exist in the plant by which secondary effects of the action of external factors, or of morphogenic or embryonic procedure, may be freely communicated from one part of the soma to another and from the egg to the soma.”<sup>2</sup>

Charles B. Davenport also of the Carnegie Institution and Secretary of the American Genetic Association championed the cause of mutation, and Professor Eigenmann advocated “selective adaptations” as a factor to be reckoned with. “Adaptations,” he says, “have usually been looked upon as adjustments in the organism to its environment. The suggestion has more recently been made that adapted environments and habits are selected by animals adjusted to them. . . . The shore-fishes, channel-fishes, etc., depending on light to find their food and mates, moved out to the Green River, where their descendents live to the present day. The fishes negatively heliotropic, nocturnal, or stereotropic, moved into the holes dissolved in the bottom of the river, followed its subterranean development, and their descendents live today in the stream which now flows entirely below the valley. . . . Primarily blind fishes do not have degenerate eyes because they live in caves, but they live in

<sup>1</sup> *Fifty Years of Darwinism*, p. 109.

<sup>2</sup> *Ibid.*, p. 120.



caves because their ancestors were adjusted to do without the use of eyes.”<sup>1</sup>

Another paper by H. F. Osborn of Columbia is of interest because it re-emphasizes the value of the theory of variation by “organic selection” formulated some years ago by Baldwin and himself in this country and by Lloyd Morgan in England. Baldwin gives this explanation: “It claims that it is possible for intelligent adaptations, or any sort of ‘modification’ made by the individuals of one generation, to set the direction of subsequent evolution, even though there be no direct inheritance of acquired characters from father to son.”<sup>2</sup>

Osborn, in the paper cited, contends for law-abiding rather than fortuitous variations,<sup>3</sup> and formulates his own theory as follows:—

The life and evolution of organisms continually center around the processes which we term heredity, ontogeny, environment and selection; these have been inseparable and interacting from the beginning; a change introduced or initiated through any one of these factors causes a change in all. First, that while inseparable from the others, each process may in certain conditions become an initiative or leading factor; second, that in complex organisms one factor may at the same time be initiative to another group of characters, the inseparable action bringing about a continuously harmonious result.<sup>4</sup>

An additional citation may well be made from a recent work by Professor Loeb of the Rockefeller Institute because of his recognized authority. Professor Loeb has endeavored to reduce all life to terms of the physical and chemical interaction.<sup>5</sup> While discrediting the theory formulated by Fournier, that the results of muscular activity may be inherited by their effect on the central nervous system and through this on the germ plasm, he goes on to say:—

If we thus deny the *immediate* influence of the central nervous system on the germ, and assume a chemical theory of heredity, it might still be possible that the central nervous system could influence heredity indirectly, in so far

<sup>1</sup> *Fifty Years of Darwinism*, pp. 183, 189.

<sup>2</sup> *Story of the Mind*, p. 34. Cf. Conn, *Method of Evolution*, pp. 306 ff.; also Thomson, *Darwinism and Human Life*, p. 169.

<sup>3</sup> *Fifty Years of Darwinism*, p. 225.

<sup>4</sup> *Ibid.*, p. 238.

<sup>5</sup> Especially in his *Mechanistic Universe*.

as it can affect the chemical processes of the body. As illustrations of a chemical effect of the nerves, the fact is mentioned that stimulation of the nerves of certain glands produces a secretion. Mathews has shown, however, that in cases where stimulation of the sympathetic system produces a secretion, the glands contain muscular fibres which contract when stimulated, and in this way press a liquid out of the ducts. . . . There are no specifically trophic nerves, but it is possible that many nerves produce indirectly (for instance, through disturbances of the circulation and limitation of the supply of oxygen) such extensive chemical changes that morphological changes of the tissue ensue. If this is really the case, a possibility still exists that the central nervous system also affects the sexual cells indirectly, in so far as disturbances of circulation and hence chemical changes are produced, which may modify the sexual cells contained in the testes and ovaries chemically. Thus there might be a very remote chance that brain-activity of one generation might lead to the formation of chemical substances which affect the sexual cells. . . . We arrive thus at the conclusion that a transmission of hereditary characteristics through the egg is only possible in the form of specific chemical substances, and that the central nervous system could only influence heredity, if it could bring about the formation of special substances in the egg (by influencing metabolism).<sup>1</sup>

This quotation is in harmony with the suggestion of Professor Wilson as to the operation of "hormones."<sup>2</sup>

In the babel of voices can we hear a single clear word of use in the study of social progress? That nature is prodigal is certain but decreasingly so as we rise in the scale to the higher species where a large proportion of the offspring reach maturity. Variation is the law of life, — and more universal than Darwin imagined.<sup>3</sup> Struggle for existence is unquestionable if we accept the term in the large and metaphorical sense as used by Darwin and more recently by Thomson.<sup>4</sup> As to the causes of variation, however, the "doctors disagree" so too, as to the potency of

<sup>1</sup> *Physiology of the Brain*, pp. 208 ff.

<sup>2</sup> *Ibid.*, p. 79.

<sup>3</sup> Cf. Conn, *Method of Evolution*, pp. 108 ff.; Wallace, *Darwinism*, ch. III.

<sup>4</sup> Thomson mentions three classes of struggle for existence: (1) struggle between fellows, (2) struggle between foes, (3) struggle with fate. In the first, "the struggle does not need to be direct to be real, — the essential point is that the competitors seek after the same desiderata of which there is a limited supply. In the second, it is between individuals and between species, sometimes to the death. In the third, our sweep widens still further, and we pass beyond the idea of competition altogether, to cases where the struggle for existence is between the living organism and the inanimate conditions of life, — for instance, between birds and the winter's cold, between aquatic animals and changes in the water, between plants and drought, between plants and frost . . . in a wide sense, between Life and Fate."

natural selection in the struggle between individuals where Darwin laid chief emphasis.<sup>1</sup>

There seems to be a strong tendency now to accept the theory of mutations in the line of inheritable unit characters, to emphasize the unity of the species in the struggle for existence and to rate highly the importance of geographical isolation in the formation of new species and ethnic groups. There seems to be a tendency in certain quarters, also, following the lead of Nägeli and Driesch, to return to the hyper-scientific method of earlier days and posit a life principle or force as the mainspring of development. This is strongly opposed, however, by those who hold that science is weakened just in proportion as it gets beyond the domain of demonstrable facts, so on the whole sociology can claim little support for this theory from biologists of recognized authority.<sup>2</sup>

Most clear and certain of all, it would seem, stands out above the confusion of present biological knowledge and hypotheses the doctrine of adaptation though with differences of interpretation and emphasis. In proportion as the struggle is between individuals, either friends or foes, the weak and otherwise less adapted tend to be eliminated, but in proportion as the struggle is between groups certain instincts seem to have been evolved which have as their specific function the strengthening of the group in collective activity. Some of these instincts seem to work for the detriment of the individual member who does not fit in with the "group sentiment of safety"<sup>3</sup> or whose death will in some way be advantageous to the group as in the destruction of the weak, the

<sup>1</sup> For a sane criticism of Darwinism, see Kellogg, *Darwinism To-day*, chs. III, IV, V.

<sup>2</sup> Although this theory is in general repudiated as extra-scientific and tending to turn scientists aside from their supreme task of finding out the efficient causes of change, the vast realm of mystery that still baffles biologists in their endeavor to explain the process of biological evolution and has led some to posit a force or intelligence as the cause of these changes, gives a vantage ground for social philosophers who are not limited, as are scientists, to mere description in terms of co-existence and sequence, but have as their task to push their investigations and formulations on to an underlying or final cause as have Ratzenhofer, Fiske, and Ward. Cf. Kellogg, *op. cit.*, pp. 226 f.

<sup>3</sup> Ward, *Pure Sociology*, pp. 134, 419.

mained and the "drones"; sometimes, however, it seems to manifest itself in defence of the helpless and weak, thus providing the biological background of "mutual aid" in the social behavior of men.<sup>1</sup> But the range of mal-adaptation possible before elimination takes place is often wide,<sup>2</sup>—and here again the decisive factor is the severity of the struggle for existence, and although adaptation in the strict use of the term and in every particular may not be necessary to the mere existence of the individual to the point of reproduction and so to the point necessary for the preservation of the species, adaptation in this sense is necessary for the largest possible life of which any individual or species is capable. The pine tree of the tropics is vastly different from the pine tree of the cold regions.

Permanent modifications within a species, as in the formation of new varieties seem to come: (1) as a result of inter-crossing; (2) through a great change in the environment affecting a certain portion of the species eliminating all but those whose variations from the type prove best adapted to the new conditions of life; (3) through geographical isolation resulting in inbreeding and the selective pressure of a different combination of environmental conditions, or (4) by spontaneous variation or mutation often with the potency of development, arising by a process as yet unknown.<sup>3</sup> When the changes are sufficiently great, especially when the reproductive functions are affected so as to make the individuals of the variety and the parent species infertile when crossed, we have a new species.

As tropisms, reflexes and instincts are inborn characters, or based on such, their origin is to be explained in accordance with the above principles, and they are to be considered as on the whole of adaptive value either to the individual or to the species.<sup>4</sup> They may persist, however, as "vestiges" even though disuseful, providing this disutility is not sufficient to lead to elimination.

The human organism is in direct descent from the anthropoid apes or from the common precursor of these and man, and the

<sup>1</sup> Kropotkin, *Mutual Aid*.

<sup>2</sup> Kellogg, *op. cit.*, p. 227.

<sup>3</sup> For discussion of "Varieties" see Walter, *Genetics*, pp. 60 f.

<sup>4</sup> Colvin and Bagley, *Human Behavior*, pp. 21-25, 126 ff.; Miller, *Psychology of Thinking*, pp. 18 f.; Parmelee, *Science of Human Behavior*, pp. 105 ff.

existence of all human qualities is to be explained, if at all, on the assumption that they have been of value on the whole in the struggle for existence.

Some modern genetic psychologists and sociologists, working on the above premises, and studying the behavior of animals and infants to get a clue to the behavior of man, have formulated the following conclusions which may well be included with the above:—

When unconscious reactions were not adequate to survival, consciousness, in some cases, seems to have arisen as an adaptive response to this need, and having arisen, developed rapidly.<sup>1</sup>

Every organism tends to respond positively to stimuli that are favorable and negatively to those that are unfavorable, and a favorable reaction tends to be repeated. In this way innate tendencies are modified and habits formed.<sup>2</sup>

In higher organisms endowed with feeling, reactions that are favorable to the individual or species are accompanied, on the whole, by pleasurable sensations, those that are unfavorable, by painful sensations.<sup>3</sup>

With the development of the human intellect giving man the power of selection among satisfiers of felt needs arose the possibility of a selection that was detrimental to the organism and to the species.<sup>4</sup>

With the rise of conscious, purposeful choice, came the power of *active adaptation*,—i. e., the purposeful modification of the individual or group to make it better adapted to life conditions, or the purposeful modification of the life conditions to make them more favorable to the individual or group.<sup>5</sup>

<sup>1</sup> Ellwood, *Sociology in its Psychological Aspects*, p. 98.

<sup>2</sup> *Ibid.*, pp. 106 f.; Thorndike, *Original Nature of Man*, ch. IX.

<sup>3</sup> Parmelee, *op. cit.*, pp. 232 f.; Ward, *Pure Sociology*, p. 130: "All pleasure is mandatory and all pain is monitory. . . . So long as feeling and function are adapted pleasure means life and health and growth and multiplication, while pain points to danger, injury, waste, destruction, death, and race extinction."

<sup>4</sup> Miller, *op. cit.*, pp. 44 f.

<sup>5</sup> Ellwood, *op. cit.*, pp. 104 f.

## CHAPTER V

### NEO-DARWINIAN SOCIOLOGISTS

HAVING made our approach through biological evolution especially as interpreted by Darwin and his successors, we will take up in this chapter the contributions to our subject from some representative social philosophers who make use primarily of the neo-Darwinian formula, and to this extent of the principle of passive adaptation, considering here Nietzsche, Kidd, Galton, Pearson and Lapouge.

FRIEDRICH NIETZSCHE (1844-1900)

#### *Evolution of the Super-Man*

Although Nietzsche is not usually classed as a sociologist, his writings have had profound influence on modern social philosophy, especially as represented in drama, novel, magazine and newspaper. According to Mencken he reigns as king in the German universities.<sup>1</sup>

Nietzsche's philosophy, according to the same commentator, consists of the following propositions:<sup>2</sup>—

1. That the ever-dominant and only inherent impulse in all living beings, including man, is the will to remain alive, — the will, that is, to attain power over those forces which make life difficult or impossible.

2. That all schemes of morality are nothing more than efforts to put into permanent codes the expedients found useful by some given race in the course of its successful endeavors to remain alive.

3. That, despite the universal tendency to give these codes authority by crediting them to some god, they are essentially man-made and mutable, and so change, or should change, as the conditions of human existence in the world are modified.

<sup>1</sup> *The Philosophy of Nietzsche*, p. vii.

<sup>2</sup> *Ibid.*, pp. ix, x.

4. That the human race should endeavor to make its mastery over its environment more and more certain, and that it is its destiny, therefore, to widen more and more the gap which now separates it from the lower races of animals.

5. That any code of morality which retains its permanence and authority after the conditions of existence which gave rise to it have changed, works against this upward progress of mankind toward greater and greater efficiency.

6. That all gods and religions, because they have for their main object the protection of moral codes against change, are inimical to the life and well-being of healthy and efficient men.

7. That all the ideas which grow out of such gods and religions — such, for example, as the Christian ideas of humility, of self-sacrifice and of brotherhood, — are enemies of life, too.

8. That human beings of the ruling, efficient class should reject all gods and religions, and with them the morality at the bottom of them and the ideas which grow out of them, and restore to its ancient kingship that primal instinct which enables every efficient individual to differentiate between the things which are beneficial to him and the things which are harmful.

This analysis would seem to indicate that Nietzsche should be classified rather among those who have contributed chiefly to the development of the doctrine of active adaptation, but his philosophy is rooted fundamentally on two assumptions: The will to live as the primary element in human life, and the development, by the law of struggle and survival, of the super-man in whom this will to live shall find the highest possible expression.

We shall concern ourselves here chiefly with the second of these fundamental elements.

One can understand the evolution of Nietzsche's system only in the light of his temperament and life. He was born in 1844 into the home of a Lutheran pastor of Röcken. Bereft of his father at four years of age, he, with two sisters, was brought up in the companionship of four pious women.<sup>1</sup> The idol of the home, now changed to Naumburg-on-the-Saale, "the boy shrank from the touch of the world's rough hand," until he entered the Gym-

<sup>1</sup> *The Philosophy of Nietzsche*, pp. 10 f.

nasium. Here he received a mental and spiritual shock which to one of his temperament and early training had much to do with the transformation of his unsophisticated piety and credulity to dionysian iconoclasm.

The influence of Ritschl, the celebrated philologist at Bonn and Leipsic, was very great on the developing youth <sup>1</sup> but greater yet that of the writings of Schopenhauer which he read in 1865, but interpreted in the light of Darwin's theory of natural selection with which he became acquainted during his first years at Bonn.<sup>2</sup> *Schopenhauer interpreted in the light of the doctrine that progress results from struggle for existence and survival of the fittest is thus the very heart of Nietzscheism.*<sup>3</sup>

Our author arrived at manhood in the flush of an intellectual period when monistic philosophy and the scientific method were being turned to a criticism of all of life's conventions and values. The cataclysm in Nietzsche's moral and religious ideas and beliefs made the conventional standards in these departments of life values his special concern, and later his special point of attack, and he became one of the most virulent and blasphemous of moral and religious critics.

In his attack on David Strauss in 1873, he charges that philosopher and critic with lack of courage in failing to follow out the Darwinian formula to its logical conclusion.<sup>4</sup> The same argument would apply to Darwin himself, and to Wallace, Fiske, Balfour and Huxley, as Dr. A. Lilly points out, for none of these apply the biological formula in all its rigidity to social progress, or to the development of moral sentiments. The consensus of opinion today, however, among sociologists is with Darwin rather than with Nietzsche and his defenders as we shall point out later. To say that the law of natural selection does not apply rigidly in social evolution is not to pit man against the cosmic process, for man with his intelligence and will is a part of that process, so also are society and the social sentiments.<sup>5</sup> The reasoning of the Nietzscheans is far from conclusive.<sup>6</sup>

<sup>1</sup> *The Philosophy of Nietzsche*, p. 16.

<sup>2</sup> *Ibid.*, p. 13.

<sup>3</sup> Cf. Mencken, pp. 64 ff., 101 f., 138 f., esp. 142 n.

<sup>4</sup> *Ibid.*, p. 30.

<sup>5</sup> For Drummond's position as against Huxley see his *Ascent of Man*, ch. I.

<sup>6</sup> Introduction to *The Case Against Wagner*, etc., cf. Mencken, p. 140.



Nietzsche's peculiar reaction against the naturalistic ethics of Darwin and the English utilitarians is doubtless to be explained also in the light of his temperament, early training and violent reaction which carried him to the extreme of conventional iconoclasm. Naturalistic ethics made large place for sympathy, sociability and self-sacrifice. Nietzsche, an eccentric egoist, with *will to power* and *natural selection* forming an *idée fixe*, re-enforced by the experience which came by defying, with more or less success, the forces both physical and moral which seemed allied against him, had to find some other explanation for the origin of moral sentiments than that given by the Darwinians.

His approach was through his specialty, philology, and he tried to prove by the derivation of words used to express ethical concepts that the moral code of Christendom was a "slave morality" imposed by the ruling classes for their own advantage. The résumé of the process by which he obtained "enlightenment" as set forth in *A Genealogy of Morals* indicates the pressure of his individualistic bias. His violence against traditional Christianity is likewise explained. The Christianity with which he was most familiar was that typified on the one hand by the life of Saint Francis of Assisi and on the other that set forth dogmatically by Albrecht Ritschl who was Professor of Systematic Theology at Bonn during his student days there. The negation of the *will to live* which found its greatest Christian example in Saint Francis must necessarily call forth violent opposition from one of Nietzsche's temperament and life philosophy.<sup>1</sup>

His study of the genesis of moral ideas is unsatisfactory from biological and anthropological viewpoints, and seems strained even from that of philology. To try to explain the herding instinct among men which is so pronounced among certain species of mammals as a social institution produced by the combining of the many weak against the few strong, is too absurd to merit serious consideration.<sup>2</sup>

With Nietzsche the good is that which advances the will to live, the bad, that which hinders it. But he never gets beyond the

<sup>1</sup> *A Genealogy of Morals*, Third Essay, cf. Mencken, p. 143.

<sup>2</sup> *A Genealogy of Morals*, p. 17.

individual. Now granted that personal might made right in primitive times; that "gut" is related to the ruling "Goths"; that "schlecht" is identical with "schlicht," — simple, common; that purity is merely ceremonial and priestly in its origin, — all this does not invalidate the social utility of conventions thus derived. Nietzsche seems entirely oblivious to that social phenomenon emphasized by Darwin, Fiske, Drummond and in fact by practically all sociologists, viz., the prevalence and persistence in early times of the inter-group struggle, and the survival of that group which was the most powerful, not only by virtue of physical strength but of organization based on social qualities possessed by the members. According to consistent Darwinism no Nietzschean group could have survived to transmit its theory of life by congenital variation or social heredity, — nor is it probable that it could today. It is destructive to the family as well as to the state and can lead only to self-annihilation. Thus it is not social ethics that leads to destruction but dionysian individualism. A study of the history of Nietzscheans for a few generations would be illuminating. If all were such woman-haters as the founder there would be no normal generation.

Nietzsche's chief contribution to the development of the doctrine of passive material adaptation is by virtue of the fallacies in his opposition. Indeed he positively repudiates the doctrine as contrary to the notion of functional activity.

Laboring under this idiosyncrasy, "adaptation," that is to say, a secondary activity, in fact, a mere reactivity, is pushed into the foreground, and indeed, life itself has even been defined as "a continuous better adjustment of internal relations to external relations" (Mr. Herbert Spencer). But this is to mistake the true nature and function of life, which is *will to power*. It is to overlook the principal priority which the spontaneous, aggressive, transgressive, new-interpretative and new-directive forces possess, from the result of which "adaptation" follows. It is to deny the sovereign office of the highest functionaries in the organism, in which functionaries the will to live appears as an active and formative principle. The readers will recall here what Huxley objected to in Spencer — his "Administrative Nihilism." But we have to deal here with much more than mere "administration."<sup>1</sup>

His failure here is in his inability to see that adaptation may be interpreted to include the very *will to life and power* for which

<sup>1</sup> *A Genealogy of Morals*, p. 95.

he stands, — except in the extreme form which characterizes his theory.

Nietzsche, like many another critic, drives out a theory at the front door only to let it in at the rear. Self-denial and self-sacrifice, the products of slave-morality, are to be despised, — yet every individual, he holds, is to deny himself the gratification of certain impulses that he may attain greater future life and power. Likewise the aristocracy of the present generation are to become dionysians in the interest of the super-man of the future, — but Nietzsche provides no sanction for such sacrifice, save an appeal to the law of cosmic evolution. Such a sacrifice has no rational sanction, however, according to his theory, and all super-rational sanctions are tabooed.

Nietzsche contributed to the development of the doctrine of passive social adaptation by emphasizing the relativity of ethical ideals, but this had been done previously by Comte and Spencer. He went to the extreme, however, in his devaluation of all values.

The brief outline and few quotations given above indicate how great emphasis our author placed on the power of individual initiative, thus paving the way for a reaction against the *laissez faire* tendency growing out of the first application of scientific methods to social phenomena. In this way he has contributed very greatly to the development of the doctrine of active adaptation in all its phases.

The philosophy of Nietzsche applied to the group fitted in admirably with the statecraft of Bismarck and together they have inspired the German people to become a dionysian group; but applied to the state this social theory loses its distinctive Nietzschean quality and takes on the character of the social theories of Kidd, Pearson, and Carver in which some of the very qualities so bitterly denounced by our author come to have supreme importance.

BENJAMIN KIDD (1858- )

*Religion and Social Progress*

Nietzsche took as his point of departure Schopenhauer's *will to live* interpreted in terms of Darwin's formula of struggle for existence between individuals. Kidd takes as his, a belief in

supernatural religion and Weismann's formula with emphasis on the survival of the species. The work of the former is largely destructive; that of the latter apologetic and constructive.

Both writers are hyper-imaginative and dogmatic, presenting mere hypotheses with the certitude of well-established scientific facts, and reading into these hypotheses their own interpretations. Mr. Kidd's air of authority and use of superlatives tend to make the unsophisticated believe that the ultimate truth in social philosophy has at last been discovered. This characteristic is illustrated by the use, in the first three pages of his *Social Evolution*, of such terms as "profoundly," "stupendous," "helpless," "onslaught," "most remarkable," "most commanding," "pregnant." His rigid application to social progress of the formula of Weismann is shown by the following:—

Left to himself, this high born creature [man], whose progress we seem to take for granted, has not the slightest innate tendency to make any progress whatever. It may appear strange, but it is strictly true, that if each of us were allowed by the conditions of life to follow his own inclinations, the average of one generation would have no tendency whatever to rise beyond the average of the preceding one, but distinctly the reverse. This is not a peculiarity of man; it has been a law of life from the beginning, and it continues to be a universal law which we have no power to alter. . . . Progress everywhere from the beginning of life has been effected in the same way, and it is possible in no other way. It is the result of selection and rejection. . . . To formulate this as the inevitable law of progress since the beginning of life has been one of the principal results of the biological science of the century; and recent work, including the remarkable contributions of Professor Weismann in Germany, has all tended to establish it on foundations which are not now likely to be shaken.<sup>1</sup>

The above quotation shows not only Mr. Kidd's dogmatic spirit, but the further fact that his social theory is built up deductively on the teachings of Weismann with sole emphasis on natural selection as the method of progress, degeneration resulting from the cessation of this process and by "pan-mixia" or general breeding.

Our author shows how wide-spread has been this struggle for existence in social evolution and how it exists today not only between individuals, but between classes, nations and races. He

<sup>1</sup> *Social Evolution*, p. 36.

pictures the misery of the exploited classes in industrial centers and seems to feel that all this is natural and necessary, — necessary for the good of the social organism with special emphasis on unborn generations.<sup>1</sup>

Having read the first three chapters with emphasis on rivalry between individuals as a basis of selection, — though he fails to indicate how there can be selection for he admits that the masses who do not succeed leave the largest number of offspring,<sup>2</sup> — one is surprised to find later that Mr. Kidd repudiates the commonly accepted belief among biological sociologists concerning the differential in average mental capacity between primitive and modern man.<sup>3</sup> His view seems to be that with the advent of man natural selection turned to the production of those qualities of character which make for group efficiency such as energy, vigor,<sup>4</sup> virility, courage, integrity<sup>5</sup> and simple-minded devotion to conceptions of duty,<sup>6</sup> but he fails to show how these qualities are produced. He lays great stress on the increasing prevalence of the doctrine of the equality of all men and traces this to “the great fund of altruistic feeling generated by the ethical system upon which our civilization is founded,”<sup>7</sup> — but he does not furnish a shred of evidence that this feeling is due to selection rather than to the increase of co-operation, intercourse and education. Indeed as to the other qualities which he holds to be of supreme worth in the individuals of the successful group, — these are the result of a complex of physical and social conditions and by no means solely the product of selection. In other words, there is no more reason for believing that the western nations excel others in the social and religious instincts than there is for believing that they excel in average mental ability.

The struggle between groups results, as Kidd shows, in the survival of the groups that on the whole are best adapted to the conditions of life in which they are placed, and survival power depends not only on the social efficiency of the individual members, but on the efficiency of the social organization.<sup>8</sup> It depends

<sup>1</sup> *Social Evolution*, ch. II.

<sup>2</sup> *Ibid.*, pp. 278 f., 372, 384.

<sup>3</sup> *Ibid.*, ch. IX.

<sup>4</sup> *Ibid.*, p. 58.

<sup>5</sup> *Ibid.*, p. 61.

<sup>6</sup> *Ibid.*, p. 349.

<sup>7</sup> *Ibid.*, p. 182.

<sup>8</sup> *Ibid.*, pp. 68 f.

primarily, however, according to our author, on religion, which provides a super-rational sanction for the self-sacrificing conduct which is required of the great majority of people that their group may succeed, and especially that social progress may be furthered to the advantage of future generations.<sup>1</sup> "The greatest good which the evolutionary forces, operating in society, are working out," he says, "is the good of the social organism as a whole. The greatest number in this sense is comprised of the members of generations yet unborn or unthought of, to whose interests the existing individuals are absolutely indifferent."<sup>2</sup> This he terms the law of projected efficiency.

This law of projected efficiency is the key to the understanding of Kidd's social philosophy, so must be explained. He makes use of this law in the later chapters of *Social Evolution*, but it is developed at length in his *Principles of Western Civilization*. He claims biological support for it in Weismann's essay on *Duration of Life*, but so far as I can discover there is not one word in the whole essay that, fairly interpreted, warrants the conclusion Mr. Kidd draws. All Professor Weismann claims is that duration of life in a given species is dependent on an internal principle determined by utility to the species in its struggle for existence, — a theory which has received added confirmation in recent studies concerning Mendelian characters. Yet this theory of projected efficiency is enunciated by Kidd as if it were a demonstrated fact and we are told that "Never before has a principle of such reach in the social sciences emerged into view." In explanation of its workings, he says: —

What we are now brought to see is that the overwhelming weight of numbers as of interests, in the evolutionary process, is never in the present. It is always in the future. . . . We are, in other words, brought face to face with the fact that, in the scientific formula of the life of any existing type of social order destined to maintain its place in the future, the interests of these existing individuals, with which we have been so preoccupied, possess no meaning, except so far as they are included in, and are subordinate to, the interests of a developing system of social order, the overwhelming proportion of whose members are still in the future.<sup>3</sup>

<sup>1</sup> *Social Evolution*, ch. IV.

<sup>2</sup> *Ibid.*, p. 312.

<sup>3</sup> *Principles of Western Civilization*, p. 4, cf. p. 65.

Let us examine the facts as taught in biology and contrast them with the interpretation given by the author under consideration. According to Darwin biological evolution has resulted from increase of numbers beyond means of subsistence, struggle for existence and the survival of those best adapted to the conditions of life. According to Weismann the struggle is not so much between individuals as between species and variations may conceivably be preserved which would prove disadvantageous to the individual if he had to carry on the struggle independently, but which are advantageous to the group in competition with nature or with other groups.<sup>1</sup> Now under static conditions the curve showing the "norm" or "type" represents those on the whole best adapted for survival, but under dynamic conditions, especially in the physical environment, some individuals varying from the norm will have the advantage and survive, thus permanently modifying the species. Shortness of life in the individual, according to Weismann in the essay quoted, may be considered favorable to a species in a dynamic environment calling for frequent modifications of the "type" in order that the species may persist. The species living under such conditions that evolves an inner principle which causes death when the individual has ceased to be of service to the group, has an advantage in competition with other groups or species where certain individuals live on as a burden to others. Brevity of life for the individual, then, may be of value to the species, though in general brevity of life is considered disadvantageous. Now "species" is a generic term and includes past, present and future. Having seen that a variation may be of advantage to the species though possibly disadvantageous to the individual, it is but a step to say that as the great bulk of those who comprise the species and who are to receive the benefit of this variation are yet unborn, therefore the benefits of the variation are "projected" into the future. We thus have "projected efficiency."

Mr. Kidd's chief error is in conceiving that a quality can be of advantage to the species which is not at the same time of advantage to the great majority of individuals that compose it at any

<sup>1</sup> Recognized by Darwin, but not emphasized.

one time.<sup>1</sup> "Species" is but a class term and a species can survive only through the survival of individuals. In a dynamic environment a species cannot persist without modification and if changes in the type occur there is no special advantage in keeping the same name. In the above illustration from Weismann, if brevity of life in the individual is advantageous to the species in its present struggle, it is advantageous to the individuals composing the species, for if nature did not terminate life when the individual had ceased to be of service to the group, the group as such would have to make way with it, that is, if the struggle for existence were sufficiently acute, — even as happens in some species. The same thing holds true of man. Among some primitive tribes the aged are cast off to die. It would be of advantage to the individuals under such conditions if there were an inner principle which would bring life to an end as soon as such social disutility occurred as to lead to their destruction by the group.

This theory of projected efficiency, calling for the sacrifice of the vast majority of living individuals to the good of unborn generations, gives Kidd the background for his emphasis on the need of a super-rational sanction which will hold the members of a group to their thankless but inevitable task.

Reason, which in his conception is the cold calculating faculty that enables one to balance pleasures and pains and choose conduct in the line of self-interest cannot furnish a sanction, for if allowed full sway it would lead to the establishment of some kind of socialistic or anarchistic scheme which would mean present gain though future disaster to the race.<sup>2</sup> Reason is considered to be diametrically opposed to "belief" and "ultra-rational." There can be no such thing, according to our author, as a reasonable religion.<sup>3</sup> Religion is not only super-rational but irrational.

Mr. Kidd's chief contributions to the development of the doctrine of adaptation are (1) emphasis on the development by inter-group conflict of the social and moral qualities which make

<sup>1</sup> His illustrations from social evolution, *Social Evolution*, chs. VI and VII, have no biological analogue.

<sup>2</sup> *Ibid.*, pp. 67 ff.

<sup>3</sup> *Ibid.*, pp. 107 f.



for group strength thus affording a wholesome antidote to Nietzsche; (2) the value he places on religion as a factor in group survival; (3) his criticism of the over-emphasis on the intellectual element in social progress as in the writings of Buckle, though here he is weak in failing to appreciate the value of the intellect in active social adaptation; and (4) his doctrine of projected efficiency which, though untenable as formulated by him, is most suggestive especially as a principle of social control. As such it means merely that the group that would be immortal must use forethought and see to it that those qualities and conditions are developed which make for group strength not only in the present but in the distant future and that those which weaken the group are eliminated, — but this is entirely foreign to the thought of our author.

The most serious objections to Kidd's social philosophy are (1) his use of the deductive and analogical method almost exclusively, rather than the inductive; (2) his loose, inconsistent use of biological formulae as applied to social progress; (3) his hyper-acute imagination which reads into biological theories what was never intended by the author; (4) his dogmatic setting forth of mere hypotheses as assured laws; (5) his use of the term organism to include the future, for there can be no organism apart from organization; and (6) his conception of reason as diametrically opposed to faith on the one hand and to everything that does not favor narrow self-interest on the other. This is due to his failure to recognize the function of the self-regarding sentiment as it expands to include ever wider circles of individuals with whom self-interest is identified. Just as reason leads us to deny ourselves a present for a future enjoyment, and one that is sensual for one that is intellectual, so it may lead us to deny an egoistic satisfaction for one that comes as a result of success to our family, club, church or state.<sup>1</sup> Moreover Kidd fails utterly to note the function of reason in mitigating social misery. He pictures the awful condition of the poor in industrial centers and cites this as an example of the sacrifice required on the part of the toiling masses that the group may succeed and that social progress may

<sup>1</sup> For the development of this thought, see *infra*, chs. VII, XV, and Conclusion.

be advanced, — and finds no rational sanction for such sacrifice; but the pity of it all is that religion is invoked to keep them to their hard lot when in fact social welfare demands that their condition be changed. It is true that there is no rational sanction for the condition of the millions of the industrially exploited, nor should there be any super-rational sanction.

#### GALTON AND PEARSON <sup>1</sup>

##### *National Eugenics*

These two may well be considered together for they are closely related in point of view, method and conclusions, and moreover have been associated in their life work, — the latter being the present director of the Eugenics Laboratory at London, founded by the former.

Sir Francis Galton, cousin of Charles Darwin, well versed both in medicine and mathematics, is known chiefly as the author of *Hereditary Genius* and founder of the modern science of national eugenics. This new science was thus defined by its founder in establishing the laboratory in connection with the University of London: "National eugenics is the study of those agencies under social control, which may improve or impair the racial qualities of future generations, either physically or mentally."<sup>2</sup> This definition is interpreted somewhat differently by Professor Pearson in *Lecture Series*, nos. I and VII. In the former he says, "The word *eugenic* here has the double sense of the English well-bred, goodness of nature and goodness of nurture. Our science does not propose to confine its attention to problems of inheritance only, but to deal also with problems of environment and nurture."<sup>3</sup> In the pamphlet published two years later practically all the stress is placed on *nature* as over-against *nurture*. Here *racial* is given most prominence and is defined as follows: "We understand by a racial character, one which is the product of many generations of selecting, one which passes from generation to generation, and one which is not fundamentally modified if a child be born to the race in India, Canada, or Australia. We are

<sup>1</sup> Galton, 1822-1911; Pearson, 1857-.

<sup>2</sup> *Laboratory Lecture Series*, no. ix, p. 2.

<sup>3</sup> *Ibid.*, no. i, p. 10.

looking, therefore, at the range of qualities fixed by selection and transmitted by heredity.”<sup>1</sup>

In *Hereditary Genius* Galton endeavored to trace the influence of heredity in the transmission of high mental ability, but succeeded in showing only a correlation without separating the factors of “nature” and “nurture”; yet in his discussion of *Influences that Affect the Natural Ability of Nations*, he assumes that he has shown that the qualities are *hereditary* rather than due to environment. “I shall have occasion to show,” he says, “that certain influences retard the average age of marriage, while others hasten it; . . . that an enormous effect upon the average natural ability of a race may be produced by means of those influences. I shall argue that the wisest policy is that which results in retarding the average age of marriage among the *weak* and in hastening it among the *vigorous* classes; whereas, most unhappily for us, the influence of numerous social agencies has been strongly and banefully exerted in precisely the opposite direction.”<sup>2</sup> He discusses not only the effect of the age of marriage, but also of religious persecution and celibacy both of the priesthood and of a type of scholastics,<sup>3</sup> and bases his conclusion on the *innate differences* between the various classes in English society and their value to the race-stock. Now he has not proven that the lower economic classes or those who by intellectual tests stand lowest are innately inferior to the higher, yet the whole value of his argument rests on this and on the correlation between physical vigor and the possession of those qualities which make for national strength. In truth, in his prefatory chapter to the edition of 1892 where he takes his stand on Weismannism, he confuses those qualities of mind and character which may be purely psycho-social, as in the illustration given from the French Huguenots, and those that pertain to the germ plasm.<sup>4</sup> The same confusion is to be noted in his discussion of *The Comparative Worth of Different Races*. He holds that the

<sup>1</sup> *Laboratory Lecture Series*, no. vii, pp. 4 f.

<sup>2</sup> *Hereditary Genius*, p. 339 (italics ours).

<sup>3</sup> *Ibid.*, pp. 343 f. Yet he admits that celibacy is favorable to eminence, hence to the production of those utilities which make for national strength, *ibid.*, p. 320.

<sup>4</sup> *Ibid.*, p. xxiii.

average ability of the Anglo-Saxon race is about two classes above the Negro race, but about an equal degree below the ancient Athenians. This confusion of innate and acquired characters is especially pronounced in his discussion of "types," where there is not a shred of evidence adduced in support of his contention that it is a matter of race-stock<sup>1</sup> rather than of social heredity. Indeed here his argument is largely analogical.

Extensive investigations have been carried on during the past three years in connection with the Eugenics Laboratory in which the endeavor has been made to separate the influences of "nature" and "nurture" but they are only to a limited degree convincing, especially concerning the main thesis of both Galton and Pearson that the majority of each generation are the offspring of a small per cent of those in the preceding generation composing the half of the population inferior in natural ability.<sup>2</sup>

There is no question, today, among students of the subject, concerning the general facts of heredity, including the inheritance of mental and temperamental traits although these must be reduced to terms of the physical. There is great difference of opinion, however, as to the variability of the race-stock as a whole or on the average. In fact we do not know the unit characters and the combination of them which make for individual and social efficiency, and if we did, as Max Nordau has pointed out, selective breeding for "points" would probably result in lack of adaptability to general life conditions as is the case with thorough-bred animals.<sup>3</sup>

One of the recent investigations at the Eugenics Laboratory proves absolutely nothing except the difficulty of securing social data of any real value for statistical purposes. This investigation concerning *The Influence of Defective Physique and Unfavorable Home Environment on the Intelligence of School Children* by Dr. David Heron, concludes that on the basis of the data there is "little sensible effect of nurture, environment, and physique on intelligence."<sup>4</sup> This finding is so at variance with the results of

<sup>1</sup> *Hereditary Genius*, pp. 350 f. This discussion based on Darwin's theory of pangenesis was repudiated in the Preface to the 1892 edition. Cf. p. xiv.

<sup>2</sup> *Lecture Series*, no. ii, esp. pp. 16 ff.

<sup>3</sup> *Sociological Papers*, ii, p. 31.

<sup>4</sup> *Memoirs*, no. viii, p. 58.

medical inspection in schools both in England and America as to be of negative value.

Other of the studies are of far greater value, as those concerning the influence of alcohol on heredity<sup>1</sup> but even these are not conclusive, except as indicating with a good degree of certainty that chronic alcoholism is more or less a symptom of germinal defect.<sup>2</sup>

The general conclusion of all the laboratory investigations is to the effect that mental and moral traits, as well as physical, including insane and tubercular diathesis, are inheritable in about the same ratio,<sup>3</sup> and that heredity is vastly more important than environment.<sup>4</sup> The writer goes so far, even, as to hold that medical progress, by suspending the operation of natural selection by prolonging the lives of those who otherwise would have been "selected," has weakened the average quality of the race-stock,<sup>5</sup> and that this tendency can be counteracted only by national eugenics.

Mr. Galton wrote his *Hereditary Genius* from the point of view of Darwin's theories of natural selection, pangenesis and the inheritance of acquired characters, but later accepted the teachings of Weismann. Pearson, in his *Grammar of Science*, makes room for other factors in race-stock improvement besides natural selection,<sup>6</sup> but in his more recent writings he, too, has become a

<sup>1</sup> *Memoirs*, nos. x and xiii.

<sup>2</sup> For sane criticism see *Charity Organization Review*, September, 1910.

<sup>3</sup> *Lecture Series*, no. ii, p. 20. How a moral trait can be inherited is not made clear. There is a strong tendency in modern psychology and ethics to repudiate the old teaching concerning a "moral sense." Biology has not yet revealed the possibility of inheriting anything that cannot be reduced to terms of the physical (including the nervous system). If there be innate moral traits they must be a function of the nervous system. The nearest approach that modern psychology can make is in its assumption of a gregarious or social instinct, and possibly of an instinct that leads one to do as others do. Recent studies of juvenile delinquency have failed to find any specific inheritance of criminal tendencies, and criminal psychologists are now questioning the existence of the class of so-called "moral delinquents." Cf. Healey, *The Individual Delinquent*.

<sup>4</sup> "We find that the effect of nurture is on the average hardly one-fifth to one-tenth that of heredity." — *Lecture Series*, no. vii, p. 7. Yet in no case has the factor of heredity been kept entirely separate from early home training except in Galton's study of twins. Cf. Ward's *Applied Sociology*.

<sup>5</sup> *Lecture Series*, no. ix, p. 19.

<sup>6</sup> *Grammar of Science*, p. 378. Cf. concluding chapter of this volume.

Weismannian and with him emphasizes the good of the species rather than that of the individual. In the former work, also, he traces the operation of the law of evolution and selection through the three stages which he names *individualism*, *socialism* and *humanism*, but in *National Life from the Standpoint of Science* and in his published lectures the emphasis is almost entirely on the national group in its competition with other groups.

The contributions of Galton and Pearson to our subject may be summarized as follows:—

1. *Passive Physical Adaptation.* They have endeavored to prove by the biometric method that social progress is largely by natural selection: e. g., that from 60 to 70 per cent of deaths are “selective”;<sup>1</sup> that 12 per cent of one generation, and from those of inferior ability, produce 50 per cent of the next generation;<sup>2</sup> that there is correlation between physical stature and race vigor<sup>3</sup> and that urbanization leads to degeneration;<sup>4</sup> that “nature” is stronger than “nurture”;<sup>5</sup> that alcoholism is not so much the cause as the symptom of degeneration;<sup>6</sup> that intermarriage with inferior races is fatal to the higher race;<sup>7</sup> that health and vigor are the best selective qualities known at present and that the best qualities are to a large extent correlated;<sup>8</sup> but most important of all is the emphasis laid by Pearson on the importance of inter-group struggle and on the teaching that co-operation within the group is essential to make it strong in competition with other groups.<sup>9</sup>

2. *Active Material Adaptation.* The chief contribution in this department comes from Pearson’s *Grammar of Science* where he points out the utility of scientific training not only to increase the

<sup>1</sup> *Lecture Series*, no. ii, p. 22.

<sup>2</sup> *Ibid.*, p. 28.

<sup>3</sup> *Inquiries into Human Faculties*, p. 22.

<sup>4</sup> *Ibid.*, p. 24. Weakened, however, by the following: “Sickly looking and puny residents in towns may have a more suitable constitution for the special conditions of their lives, and may in some sense be better knit and do more work and live longer than much haler men imported to the same locality from elsewhere.”

<sup>5</sup> Cf. Galton’s studies of twins, *Inquiries into Human Faculties*, p. 235.

<sup>6</sup> *Memoirs*, nos. x and xiii.

<sup>7</sup> *National Life*, pp. 14 f.

<sup>8</sup> *Sociological Papers*, ii, p. 50.

<sup>9</sup> *National Life*, pp. 44 f.

comforts of life but in the interest of efficient citizenship,<sup>1</sup> and from his *National Life*, where he shows the importance of education for adaptability and group success.<sup>2</sup>

3. *Passive Spiritual Adaptation.* Galton points out the influence that customs and religion have had on marriage institutions and believes that after a time eugenics may so influence public opinion that uneugenic marriages will be tabooed and that this new science may yet receive the sanction of religion.<sup>3</sup> If this stage should be reached we would have an example of the operation of passive spiritual adaptation. Pearson emphasizes the value of scientific training to insure social stability.<sup>4</sup>

4. *Active Spiritual Adaptation.* Eugenics as defined by Galton belongs properly to this department of our subject, so that the contributions of these two on the constructive side belong here. The contrast between eugenics and evolution is well illustrated by these words from the founder of the new science:—

Eugenics strengthens the sense of social duty in so many important particulars that the conclusions derived from its study ought to find a welcome home in every tolerant religion. It promotes a far-sighted philanthropy, the acceptance of parentage as a serious responsibility, and a higher conception of patriotism. The creed of eugenics is founded upon the idea of evolution; not on a passive form of it, but on one that can, to some extent, direct its own course. Purely passive, or what may be styled mechanical evolution displays the awe-inspiring spectacle of a vast eddy of organic turmoil, originating we know not how, and traveling we know not whither. . . . Its constituents are always changing, though its shape as a whole hardly varies. Evolution is in any case a grand phantasmagoria, but it assumes an infinitely more interesting aspect under the knowledge that the intelligent action of the human will is, in some small measure, capable of guiding its course. Man has the power of doing this largely so far as the evolution of humanity is concerned; he has already affected the quality and distribution of organic life so widely that the changes on the surface of the earth, merely through his disforestings and agriculture, would be recognizable from a distance as great as that of the moon. . . .

Eugenic belief extends the function of philanthropy to future generations, it renders its action more pervading than hitherto, by dealing with families and societies in their entirety, and it enforces the importance of the marriage covenant by directing serious attention to the probable quality of the future offspring. It sternly forbids all forms of sentimental charity that are harmful to the race, while it eagerly seeks opportunity for acts of personal kind-

<sup>1</sup> pp. 7 f.

<sup>2</sup> p. 32.

<sup>3</sup> *Sociological Papers*, i, p. 12.

<sup>4</sup> *Grammar of Science*, p. 9.

ness, as some equivalent to the loss of what it forbids. It brings the tie of kinship into prominence and strongly encourages love and interest in family and race. In brief, eugenics is a virile creed, full of hopefulness and appealing to many of the noblest feelings of our nature.<sup>1</sup>

Both Galton and Pearson are to be commended for their painstaking labors in one important department of human progress. The biometric method as developed by Pearson and employed by his co-laborers is certain to prove a valuable instrument in social science although owing to the unreliable character of much of the data gathered up to the present the conclusions are far from satisfactory. The friction between the workers at the Galton Laboratory and the American workers at Cold Spring Harbor under Dr. Davenport is perhaps unfortunate, yet the rivalry and competitive criticism which is essentially a struggle for existence between statistics as applied to the study of hereditary qualities and a study of family records on the basis of the Mendelian theory of unit characters, will doubtless result in hastening a knowledge of the truth. The *Memoirs* issued from the Eugenics Laboratory are cautious and modest in their statements and conclusions, not pretending to discover causes but only correlations. In the *Lecture Series*, however, too often the suggestions of the *Memoirs* are given out as ascertained facts, and the animus shown in some of the criticisms of the Mendelian workers by those of the Galton Laboratory suggests a consciousness of weakness in the biometric methods as there used.<sup>2</sup>

The conclusions of both Galton and Pearson concerning race-stock degeneration do not seem to be borne out by the Curtis tests in arithmetic applied to more than 40,000 children in widely separated schools in several states of our country and three schools of London. These tests do not indicate that there is very much difference in natural ability between the children of the various social classes, although they do show great differences in natural ability between individual pupils in all classes.<sup>3</sup> Neither are they corroborated by use of the Binet tests on certain orphans

<sup>1</sup> *Sociological Papers*, ii, pp. 52, 53.

<sup>2</sup> See *Eugenics Record Office, Bulletin no. 11*, February, 1914.

<sup>3</sup> *Report Investigation, New York Schools*, 1912, pp. 62, 66, 74; especially tests on twins, pp. 71, 72.



received from the lowest economic classes, for the results seemed to indicate average intelligence.<sup>1</sup> So while the work of the Galton Laboratory is to be commended in a general way, the results as yet are by no means conclusive and the question of the relative importance of "nature" and "nurture" is still open.

VACHER DE LAPOUGE (1854- )

*Societal Selections*

Professor Lapouge, in his *Sélections Sociales*, takes very much the same position as Galton and Pearson concerning the application of biological formulae to social progress and the necessity of a thorough-going system of eugenics to offset the present tendency toward race degeneration. He pushes his theoretical conclusions farther than they but has not done so much in the line of original investigation. He makes more concessions than does Pearson in his most recent writings to those who hold that many influences may affect the germ plasm,<sup>2</sup> but like both Galton and Pearson holds that social progress is by selective rather than by collective evolution;<sup>3</sup> i. e., by selection within the group rather than by any process of group transformation, and like them, too, he emphasizes race far more than environment,<sup>4</sup> holding that the reason for the short and brilliant career of Portugal was due to the loss of her best blood and crossing with negro slaves,<sup>5</sup> and says that "if the Greeks of the golden age could suddenly return to life, in less than a century the center of civilization would have returned to the Acropolis."<sup>6</sup>

With Lapouge a nation or race is not a permanent type but in constant flux so that it is not able to accomplish at one time what it had been able to accomplish at a previous period,<sup>7</sup> and indeed differs so greatly in two epochs as to be equivalent to two distinct races.<sup>8</sup> He points out the fatality which results to a superior race that mixes with an inferior one that greatly exceeds it in numbers as in the case of the Spaniards in South America.

<sup>1</sup> *Survey*, November 11, 1911, p. 1188. Cf. *Report Massachusetts Commission on Increase of Crime, Insanity, etc.*, 1910; and especially Ward, *Applied Sociology*.

<sup>2</sup> *Sélections Sociales*, p. 49.

<sup>3</sup> *Ibid.*, pp. 83 f.    <sup>4</sup> *Ibid.*, pp. 60 ff.

<sup>5</sup> *Ibid.*, p. 77.

<sup>6</sup> *Ibid.*, p. 69.

<sup>7</sup> *Ibid.*, p. 62.

<sup>8</sup> *Ibid.*, p. 66.

In discussing the stages of growth and decay in a civilization, which he likens to a biological organism,<sup>1</sup> he says:—

The birth of a historic people requires the presence in a social environment of superior ethnic elements capable of directing and drawing along (entrainer) the masses. These elements . . . are regularly provided by a conquering people but they can come by pacific immigration and even, theoretically, by internal selection. . . . The period of development is that where superior elements multiply, take the direction of affairs and put on them the stamp of their personal genius. . . . The golden age is the culmination of eugenics. . . . The period of decadence follows the weakening of the superior elements and condemns itself by the division of power with inferior elements. The end comes with the complete exhaustion of eugenic capital, but a nation may still survive in this state so long as a shock from outside does not overthrow the decayed structure (*édifice vermoulu*).<sup>2</sup>

Lapouge believes that civilization leads inevitably to cerebral regression just as in the case with animals under domestication,<sup>3</sup> and that education can affect only the individual, so is limited in influence and *nil* in race-stock improvement.<sup>4</sup>

He follows Darwin and Broca in recognizing the change in the evolutionary process with the development of man's intelligence and holds with reason that "in man, social selection overrides natural selection."<sup>5</sup> Among the institutions which make for social selection, he discusses at length the military, political, religious, moral, legal and economic. Under the last he mentions age of marriage, occupational mortality, migration and urbanization.<sup>6</sup>

His conclusion is pessimistic in the extreme: "The future is not to the best, at most to the mediocre. To the degree that civilization develops, the advantages of natural selection change to a bitter scourge upon humanity. All apparent progress is at the expense of capital drawn from the force and energy, from the will and intelligence, and this capital becomes dissipated."<sup>7</sup> He holds that the testimony of paleontology is to the effect that the most perfect forms are the least stable; that the lower forms are better adapted to their environment as in the case of parasites, mi-

<sup>1</sup> *Sélections Sociales*, p. 49.

<sup>2</sup> *Ibid.*, pp. 77 f.

<sup>3</sup> *Ibid.*, p. 118.

<sup>4</sup> *Ibid.*, pp. 100 f.

<sup>5</sup> *Ibid.*, pp. 187 f.

<sup>6</sup> *Ibid.*, pp. 207-387.

<sup>7</sup> *Ibid.*, p. 406.

crobes, and insects which have destroyed the largest and best armed species.<sup>1</sup> He sees no evidence of purpose or plan in the evolutionary process, nor any guarantee for the future of humanity. Utopias, he holds, are mere phantasies of the brain.

Lapouge sees one glimmering ray of hope, — systematic selection, or what Galton and Pearson are pleased to call national eugenics. He sets forth facetiously the possibilities of zoötechnic and scientific reproduction<sup>2</sup> concluding that the triumph of statecraft would be in the breeding of a society of optimists who would always be content with everything. In this we are reminded of the ultimate stoical super-man of Nietzsche evolved by natural, however, rather than by artificial selection.

Lapouge's eugenic program is as follows:—

(1) To establish a natural aristocracy in some selected social group; (2) to establish special, distinct castes; (3) to transform the group as a whole to a fixed point; (4) to create a race that shall dominate everywhere; (5) to recast humanity completely by the aid of perfect local types; (6) to substitute for humanity as it now is a single perfect race; etc.<sup>3</sup>

This program is to be carried out in a two-fold way: by the elimination of unserviceable elements and second, by the breeding of superior elements. He realizes the difficulties in the accomplishment of the plan but looks first to the enlightenment of the people and the formation of public opinion, and then expects that some sort of socialistic régime will be necessary for its consummation.

In view of the dispute among biologists as to the place natural selection plays in biological evolution, all social philosophies based on this theory by deduction have an uncertain foundation but this foundation becomes still more unreliable when we consider that in social evolution intelligence adds a new and disturbing

<sup>1</sup> *Sélections Sociales*, p. 457.

<sup>2</sup> *Ibid.*, pp. 472 f.

<sup>3</sup> (1) De constituer une aristocratie naturelle chez un peuple déterminé; (2) de constituer des castes spécialisées et séparées; (3) de transformer intégralement un peuple à un degré déterminé; (4) de créer une race dominante ubiquiste; (5) de refondre entièrement l'humanité à l'aide des types locaux les parfaits; (6) de substituer à l'humanité actuelle une race unique et parfaite; etc." p. 484.

factor. The only safe method, then, is to secure a sure basis, if possible, by an inductive study of the process itself and only after we have done this are we in a position to criticize fairly the school of writers whom we have just reviewed.

Before passing to this inductive study, however, it will be necessary to consider another group of writers who have laid stress on the environment as the most important conditioning factor, and of these we shall consider briefly the contributions of four representative writers: Karl Marx making his approach through economics and philosophy, Buckle, through economics and statistics, and Ratzel<sup>1</sup> and Ripley through an inductive study of the influence of the physical environment on individuals and social groups.

<sup>1</sup> As interpreted by Miss Semple.

## CHAPTER VI

### THE ENVIRONMENTAL SCHOOL OF SOCIOLOGISTS

KARL MARX (1818-1883)

#### *Economic Determinism*

KARL MARX, the founder of scientific socialism, finds place in our discussion, not so much because of his contribution to the development of the doctrine of adaptation as a theory of social progress as because of his emphasis on certain features and factors of progress which properly interpreted are fundamental and have been given saner interpretation since.

Marx started as a disciple of Hegel and never entirely freed himself from Hegelian *a priori*ism and dialectic. He became a Hegelian of the Left, however, which at the time was dominated by Feuerbach whose materialistic philosophy is well summed up in the aphoristic and much-quoted expression "der Mensch ist was er isst." Like Comte, his French contemporary, Feuerbach united a scientific view of life with a passion for humanity. The result among the young Hegelians was Humanism linked with Communism. This provided a fertile soil for the production of scientific socialism with its philosophy of "economic determinism."<sup>1</sup>

The transformed Hegelianism of Marx led him to find the cause of all historical movements in material conditions.<sup>2</sup> His interest in the proletariat class with their bad conditions of life and labor,<sup>3</sup> led him to a study of the industrial revolution and its connection with feudalism. Out of this study came his teaching that class struggle is the very essence of history and that methods of production and exchange are the fundamental causes of these struggles and of the social institutions and ideals growing out of them.

<sup>1</sup> John Rae, *Contemporary Socialism*, pp. 129 f.; Kirkup, *History of Socialism*, ch. VII.

<sup>2</sup> *Manifesto of the Communist Party* (1898).

<sup>3</sup> *Capital*, pp. 392 f., 502 f.

Moreover he was familiar with the teachings of the classical economists "that labor is the source of value, but that of this value the laborer obtains for himself merely a subsistence wage,<sup>1</sup> the surplus being appropriated by the exploiting capitalist."<sup>2</sup> Such theories gave him the background for his fundamental doctrine that this theft of the surplus-value of labor is the fountain-head of all social inequality and of the modern industrial system with its exploitation of the laboring class. With these premises his conclusion was inevitable: The supreme need that the workers of each nation and ultimately of all nations should unite in a class-conscious revolution against their exploiters and secure the socialization of all wealth, all of which was the product of social labor.<sup>3</sup>

Of special interest for our purpose is Marx's philosophy of history which has come to be known as "economic determinism." This principle, set forth in the *Manifesto of the Communist Party* in 1848, drawn up jointly by Marx and Engels is stated by the latter in the introduction to the second edition to mean

That in every historical epoch, the prevailing mode of economic production and exchange, and the social organization necessarily following from it, form the basis upon which is built up, and from which alone can be explained, the political and intellectual history of that epoch; that consequently the whole history of mankind (since the dissolution of primitive tribal society, holding land in common ownership) has been a history of class struggles, contests between exploiting and exploited, ruling and oppressed classes.

Though in this quotation all the emphasis is on methods of production and exchange, the social forces were not always so narrowly limited by Marx and Engels,<sup>4</sup> nor are they so limited by leading exponents of this philosophy today, but include all human endeavor to satisfy the fundamental needs of life. In other words, as W. J. Ghent phrases it:

The economic interpretation of history is the doctrine that the relations of men to one another in the matter of making a living are the main underlying causes of men's habits of thought and feeling, their notions of right,

<sup>1</sup> *Capital*, pp. 119, 150 f., ch. XVII.

<sup>2</sup> Kirkup, *op. cit.*, p. 154; cf. *Capital*, p. 517.

<sup>3</sup> *Manifesto* (1898) p. 33, *Capital*, pp. 621, 788 f.

<sup>4</sup> Cf. Walling, *The Larger Aspects of Socialism*, p. 379.

propriety, and legality, their institutions of society and government, their wars and revolutions.<sup>1</sup>

Of the fundamental economic teachings of Marx, not one is accepted today by economists of recognized authority.<sup>2</sup> His prophecy concerning the disappearance of the middle class has failed of fulfilment. His emphasis on the conflict between the capitalistic and proletariat classes as the very essence of social and industrial evolution is now recognized as being too easy a solution of the problem of conflict of interests between classes and between groups, but his teaching that social progress and social institutions are determined largely by economic conditions, has received increasing acceptance with the passing years.<sup>3</sup>

HENRY THOMAS BUCKLE (1820-1862)

*Intellect and Environment*

Frail of body from earliest years with almost no schooling and without the home training which was the making of Spencer, Henry Thomas Buckle, self-educated, if that term is ever appropriate to use, at his death at the age of forty-one years, left a work which has placed his name high among those who have contributed to the science of social progress.

Although his rôle was that of a philosopher of history and his aim "to bring up this great department of inquiry [history] to a level with other departments" by placing it on the sure foundation of science, his *History of Civilization in England* contains much that bears directly on the development of the doctrine of adaptation as a theory of social progress.

Although well equipped for his task as to information gleaned from the study of many thousand books, as well as by extensive travel, in logic he was exceedingly weak. Here, as nowhere else, was manifested the lack of training which such a person would have received by means of a university education.

Mr. Buckle's approach to his problem was through statistics and economics, so his point of view, his illustrations and con-

<sup>1</sup> W. J. Ghent, *Mass and Class*, ch. I.

<sup>2</sup> Cf. Kirkup, *op. cit.*, pp. 154 f.

<sup>3</sup> Cf. discussion of *Active Material Adaptation*, *infra*, Part IV.

clusions, differ greatly from those of Spencer, being more like those of Comte, but most of all like those of Quêtelet whom he follows closely in many places.

Comte made use of history to illustrate his law of the three stages as the foundation of his *Philosophy* and *Polity*. Buckle made use of history to prove that a science of history was possible and especially to establish his theory that social progress was due entirely to increase of knowledge.

He shows first, by appeal to statistics, that there is regularity in the recurrence of such social phenomena as deaths, marriages, etc., demonstrating thus that there are underlying causes with laws of manifestation. From this he concludes that free will, as usually interpreted, is an illusion.<sup>1</sup> In this he goes further than Quêtelet who grants arbitrary freedom within certain limits, a theory illustrated by M. Block as follows: "L'homme est libre mais l'humanité suit sa propre voie; de sorte que l'individu se trouve comme le voyageur sur le bateau à vapeur; il peut se promener librement sur le pont à la condition de ne pas gêner les manoeuvres des marins."<sup>2</sup>

He turns next to a study of the causes of the rise and progress of civilization, making use of the statistical method in a rough, loose way, and finds that there are two fundamental factors, the external or nature, and the internal, or mind. The elements of the former are climate, food, soil and the general aspects of nature; those of the latter, the intellect and moral nature. The physical organism is practically ignored, and with it the influence of heredity, stressed so greatly by some later writers. Nor was this due to ignorance of the biological conclusions of his day including the *Origin of Species*. Numerous citations in footnotes show he was acquainted with the leading biological writings of his time. He was intimate with Spencer and in a letter refers to Darwin's *Origin of Species*. After hearing the evidence *pro* and *con* he decides that "the original distinctions of race are altogether hypothetical." "We have no decisive ground," he holds, "for saying that the moral and intellectual faculties in man are likely to be greater in an infant born in the most civilized part

<sup>1</sup> *History of Civilization*, pp. 17 f.

<sup>2</sup> *Traité de Statistique*, p. 143.



of Europe than in the wildest region of a barbarous country.”<sup>1</sup> He discredits all theories of hereditary transmission of virtues and vices, even madness, but fails to discriminate between acquired and inborn variations.<sup>2</sup> “Here then,” he says, “is the gist of the whole matter. The progress is one, not of internal power, but of external advantage.”<sup>3</sup>

This does not mean that Buckle was not a believer in the general theory of evolution but biological evolution with him stopped with the physical basis of primitive man and all further development was the result of environment and education.

With Buckle there are two separate realms, nature, with its laws of development, and the mind, with its laws. These two realms somehow interact but he makes no attempt to get at the real nexus. “On the one hand we have the human mind obeying the laws of its own existence, and, when uncontrolled by external agents, developing itself according to the conditions of its organization. On the other hand, we have what is called nature, obeying likewise its laws; but incessantly coming into contact with the minds of men, exciting their passions, stimulating their intellect, and therefore giving to their actions a direction which they would not have taken without such disturbance.”<sup>4</sup> “When we consider the incessant contact between man and the external world,” he says, “it is certain that there must be an intimate connection between human actions and physical laws,” — and he looks forward to a time when physical science shall show the connection.<sup>5</sup>

His chief contribution to our subject is in his contrast between those sections of the earth where man is dominated by his environment and where civilization is thus a product of the interplay of forces unguided by intelligence, as in Egypt and India, thus illustrating passive adaptation, and those sections of the earth where the environment has stimulated the development of the intellect until man controls nature in the interest of his highest well-being as in western Europe, thus illustrating active adaptation.

<sup>1</sup> In this he deserves great credit as being the forerunner of Ward, Kidd, Boas, Angell, and a host of other modern sociologists.

<sup>2</sup> *Op. cit.*, p. 161.

<sup>3</sup> *Op. cit.*, p. 162.

<sup>4</sup> *Op. cit.*, p. 19.

<sup>5</sup> *Op. cit.*, p. 32.

He summarizes his conclusions in the first part of Chapter III and brings out so clearly the contrast between passive and active adaptation that portions may well be given.

Looking at the history of the world as a whole, the tendency has been, in Europe, to subordinate nature to man; out of Europe, to subordinate man to nature. . . . It suggests the important consideration, that if we would understand, for instance, the history of India, we must make the external world our first study, because it has influenced man more than man has influenced it. If, on the other hand, we would understand the history of a country like France or England we must make man our principal study, because nature being comparatively weak, every step in the great progress has increased the dominion of the human mind over the agencies of the external world. Even in those countries where the power of man has reached the highest point, the pressure of nature is still immense, but it diminishes in each succeeding generation, because our increasing knowledge enables us not so much to control nature, as to foretell her movements, and thus obviate many of the evils she would otherwise occasion. . . . All around us are the traces of this glorious and successful struggle. Indeed it seems as if in Europe there was nothing man feared to attempt. The invasions of the sea repelled, and whole provinces, as in the case of Holland, rescued from its grasp; mountains cut through and turned into level roads; soils of the most obstinate sterility becoming exuberant, from the mere advance of chemical knowledge; while, in regard to electric phenomena, we see the subtlest, the most rapid, and the most mysterious of all forces, made the medium of thought and obeying even the most capricious behests of the human mind. . . . Formerly the richest countries were those in which nature was most bountiful; now the richest countries are those in which man is most active. . . . From these facts it may be fairly inferred that the advance of European civilization is characterized by a diminishing influence of physical laws, and an increasing influence of mental laws. . . . These mental laws, when ascertained, will be the ultimate basis of the history of Europe; the physical laws will be treated as of minor importance, and as merely giving rise to disturbances, the force and frequency of which have, during several centuries, perceptibly diminished.<sup>1</sup>

This conclusion leads Buckle to discuss the current metaphysical method of studying mental phenomena, — the intuitional method, as we now say, — and to suggest as Comte had done that mental phenomena must be studied in their historical manifestations as furnishing an objective, “common to all.” He was evidently reaching after the modern method of physiological-psychology.

<sup>1</sup> *History of Civilization*, pp. 138-143.

In Chapter IV he uses the historical method to discover which of the two mental factors is the more important, the intellectual or the moral nature, and concludes that

The leading countries have now, for some centuries, advanced sufficiently far to shake off the influences of those physical agencies by which, in an earlier state their career might have been troubled; and that although the moral agencies are still powerful, and still cause occasional disturbances, these are but aberrations, which, if we compare long periods of time, balance each other, and thus in the total amount entirely disappear. So that, in a great and comprehensive view, the changes in every civilized people are, in their aggregate, dependent solely on these things: first on the amount of knowledge possessed by their ablest men; secondly, on the direction which that knowledge takes, that is to say, the sort of subjects to which it refers; thirdly, and above all, on the extent to which the knowledge is diffused, and the freedom with which it pervades all classes of society.<sup>1</sup>

Buckle is open to criticism along several lines: (1) He talks much about progress without giving a definite standard.<sup>2</sup> He speaks of intellectual progress, progress of society, advance of civilization, increase of general happiness but nowhere sets forth a social goal. The dominant note, however, is the increase of man's power over the material environment which we term *active material adaptation*.

(2) Knowledge is always considered as having dynamic quality much as with Socrates, but this is not true of mere knowledge of the laws of nature which is the conception dominant in his thought.

(3) He is not clear in his definition of the moral element. In one place it would seem to be a matter of will, — "To be willing to perform our duty is the moral part; to know how to perform it is the intellectual part."<sup>3</sup> Again it would seem to consist largely of emotional elements: "If the advance of civilization and the general happiness of mankind depend more on their moral *feelings* than on their intellectual knowledge, we must of course measure the progress of society by those feelings";<sup>4</sup> but again, morality appears to be a matter of conforming to standards of conduct varying from country to country and from year to year,<sup>5</sup> while on the same page we find the statement made that "there is,

<sup>1</sup> *History of Civilization*, pp. 204, 205.

<sup>3</sup> *Ibid.*, p. 159.

<sup>4</sup> *Ibid.*, p. 159.

<sup>2</sup> *Ibid.*, pp. 158 f.

<sup>5</sup> *Ibid.*, pp. 162-163.

unquestionably, nothing to be found in the world which has undergone so little change as those great dogmas of which moral systems are composed."

(4) In discussing the influence of religion, literature and government on social progress, we are reminded of both Comte and Spencer, for with all three the doctrine of relativity is prominent, that is, religion, literature and government are all merely expressions of the life of society and relative to the degree of civilization possessed. Buckle, with Spencer, believed that the function of government should be purely negative-regulative, — to use Spencer's phrase, — and in this differed from Comte with his paternalism. Buckle failed utterly to appreciate the inspirational value of religion, literature and moral ideals and failed to evaluate correctly the more positive, constructive functions of government that have proven so essential to social well-being.

(5) His conception of law and his confusion of correlation with cause lead to serious fallacies in his argument. These errors are due to his infatuation with the statistical method without appreciating its limitations. His conception of law is brought out in a footnote where he quotes Dugald Stewart with approval as follows: "A law of nature being merely a generalization of relations, and having no existence except in the mind, is essentially intangible; and, therefore, however small the law may be, it can never admit of exceptions, though its operation may admit of innumerable exceptions."<sup>1</sup> The change in marriage rates corresponding to the rise and fall in the price of corn illustrates Buckle's conception of law.

In his investigation of the effects of environment on social conditions, again, he shows merely correlations but not proximate causes.<sup>2</sup> Granted that in Egypt with cheap food supply we have the early rise of tyrants and slaves, if we start with Buckle's assumption of natural equality, why do some become aristocrats rather than others? The true solution would seem to be either in difference of native ability, or priority in securing possession of

<sup>1</sup> *History of Civilization*, p. 28.

<sup>2</sup> For excellent criticisms see Fiske, *Cosmic Philosophy*, ii, pp. 200 f.

the most fertile land or both. That is, Buckle points out correlations rather than causes.

(6) Finally, his analysis of the mind or internal factor is faulty. It is impossible to evaluate separately the operations of thought, feeling and will. The self functions as one and to separate the working of the intellect and the moral factor is like trying to decide which comes first the chicken or the egg.

Since he did not pretend to be a scientist, as did Spencer, we should not criticize him too harshly when he invades the field of science. He did his task in calling attention, as neither Comte nor Spencer had done, to the mighty influence of the physical environment on social progress, in pointing out that evolution took a new turn when it had developed the human organism including the brain of man, and in emphasizing that distinction most important in our discussion, between what Professor Carver and others call *passive* and *active* adaptation.

The task of setting forth the relation between the physical environment and social progress, so well begun by Buckle, has been carried forward by Friedrich Ratzel, W. Z. Ripley, and others. The work of the former has been interpreted with some modifications by his pupil and disciple, Ellen Churchill Semple, and furnishes an important contribution to the doctrine of social progress by passive adaptation.

#### RATZEL-SEMPLÉ<sup>1</sup>

#### *Anthropo-Geography*

"Ratzel," says Ellen Churchill Semple, in her book, *Influence of Geographic Environment*, "performed the great service of placing anthropo-geography on a secure scientific basis. He had his forerunners in Montesquieu, Alexander von Humboldt, Buckle, Ritter, Kohl, Peschel and others; but he first investigated the subject from the modern scientific point of view, constructed his system according to the principles of evolution, and based his conclusions on world-wide inductions, for which his predecessors did not command the data."<sup>2</sup>

<sup>1</sup> F. Ratzel (1844-1904); Ellen C. Semple (1863-).

<sup>2</sup> *Influence of Geographic Environment*, Preface.

In the spirit of Ratzel and dependent on much of the data collected by him, Miss Semple makes an elaborate analysis of the potent influence of geographical factors on history. In the factors of environment we have, according to this author, a stable force yet unceasing in its operations on "shifting, plastic, progressive, retrogressive man."<sup>1</sup>

Geographic remoteness from centers of authority, as the thirteen colonies from the mother country; geographical proximity to centers of civilization, as Greece to the Orient; natural barriers that protect from migrating hordes; natural highways and waterways that serve as arteries for the flow of commerce and culture between nations, — all these, she shows, make history dependent on geography.<sup>2</sup> Yet she grants that the analysis of the interplay of physical with social forces is by no means easy. "We see the result," she says, "but find it difficult to state the equation producing the result."<sup>3</sup> Miss Semple points out how the land and sea sometimes co-operate, sometimes are opposed in influence,<sup>4</sup> and how, though each country is an independent whole and its history determined in large part by local geographical conditions, it is also influenced by those as far remote as the downfall of Rome in relation to the gradual desiccation of western Asia and the *Völkerwanderung*.<sup>5</sup>

Our author wisely discriminates between the direct and indirect influences of the geographical environment, and shows how the latter are in many respects the more potent, criticizing Buckle for over-emphasizing the importance of awe-inspiring natural phenomena in their direct effect on the human mind. "Mountain regions," she says, "discourage the budding of genius because they are areas of isolation, confinement, remote from the great currents of men and ideas that move along the river valleys. They are regions of much labor and little leisure, of poverty today and anxiety for the morrow, of toil-cramped hands and toil-dulled brains. In the fertile alluvial plains are wealth, leisure, contact with many minds, large urban centers where commodities and ideas are exchanged. The two contrasted environments produce

<sup>1</sup> *Influence of Geographic Environment*, p. 2.

<sup>2</sup> *Ibid.*, pp. 3 f.

<sup>3</sup> *Ibid.*, p. 14.

<sup>4</sup> *Ibid.*, p. 16.

<sup>5</sup> *Ibid.*, p. 17.

directly certain economic and social results, which, in turn, become the causes of secondary intellectual and artistic effects."<sup>1</sup>

She shows how this factor of geographical isolation produces social variations much as it does biological<sup>2</sup> and how in the case of colonization, if the new center of social life affords abundant opportunity for production, the result is the rejuvenation of the race.<sup>3</sup>

"Environment influences the higher, mental life of a people," says our author, "chiefly through the medium of their economic and social life." She shows how true this is concerning politics and even ethical ideas. "Political parties tend to follow geographical lines of cleavage,"<sup>4</sup> — but this is due to the fact that these lines of cleavage mark lines of divergent interests, as in our own Civil War when the mountaineers of the South sided with the Union because they had no interest in slavery.

Time is an element to be reckoned with for the influence of geographic environment takes time. "A habitat leaves upon man no ephemeral impress; it affects him in one way at a low stage of his development, and differently at a later or higher stage; because the man himself and his relation to his environment have been modified in the earlier period; but traces of that earlier adaptation survive in his maturer life."<sup>5</sup> These modifications are carried by a people in their migrations and determine their reactions to a new environment as in the case of the Moors of Spain; — "They bore the impress of Asia, Africa and Europe, and on their expulsion from Spain, carried back with them to Morocco traces of their peninsula life."<sup>6</sup>

In tracing the influence of environment, Miss Semple shows how complex is this factor, extending far beyond mere local conditions, including, in fact, the whole earth.

The earth is an inseparable whole. Each country or sea is physically and historically intelligible only as a portion of that whole. Currents and wind-systems of the oceans modify the climate of the nearby continents, and direct the first daring navigations of their peoples. . . . Europe is a part of the Atlantic coast. This is a fact so significant that the North Atlantic has become a European sea. The United States also is a part of the Atlantic

<sup>1</sup> *Influence of Geographic Environment*, p. 20.

<sup>2</sup> *Ibid.*, p. 21.

<sup>3</sup> *Ibid.*, p. 22.

<sup>4</sup> *Ibid.*, p. 23.

<sup>5</sup> *Ibid.*, p. 25.

<sup>6</sup> *Ibid.*, p. 25.

coast: this is the dominant fact of American history. China forms a section of the Pacific rim. This is the fact back of the geographic distribution of Chinese emigration to Annam, Tonkin, Siam, Malacca, the Philippines, East Indies . . . Ecuador and Peru.

As the earth is one, so is humanity. Its unity of species points to some degree of communication through a long prehistoric past. Universal history is not entitled to the name unless it embraces all parts of the earth and all peoples, whether savage or civilized. To fill the gaps in the written record it must turn to ethnography and geography, which by tracing the distribution and movements of primitive peoples can often reconstruct the most important features of their history.<sup>1</sup>

There are four fundamental classes of geographic influences according to our author: (1) direct and indirect physical, (2) direct and indirect psychical, (3) economic and social, and (4) effects upon movements of peoples. As illustrations of the direct effects working in conjunction with natural selection and especially potent on primitive man, we have variations in stature, pigmentation and acclimatization; and of the indirect effects, such anatomical changes as result from certain occupations, these in turn being due to physical environment as in the case of the thin legs and thick arms of the Payaguas Indians due to so much of their life being spent in canoes.<sup>2</sup> The psychical effects are registered in differences in temperament which differentiate peoples as well as in differences in literature and religion, while the indirect effects are seen in peculiarities of language reflecting local conditions and occupations.<sup>3</sup> Under the third class we have the effect of physical environment on a group through the natural resources provided, the occupations encouraged or discouraged and the facilities for exchange offered; and under the fourth class, "the effect of natural barriers . . . in obstructing or deflecting the course of migrating people and in giving direction to national expansion, . . . the tendency of river valleys and treeless plains to facilitate such movements, the power of rivers, lakes, bays and oceans either to block the path or open a highway, . . . and finally the influence of all these natural features in determin-

<sup>1</sup> *Influence of Geographic Environment*, p. 30.

<sup>2</sup> *Ibid.*, pp. 34 f. If due merely to occupation these characters would not be inherited.

<sup>3</sup> *Ibid.*, p. 41.



ing the territory which a people is likely to occupy, and the boundaries which shall separate them from their neighbors.”<sup>1</sup>

“The geographical environment of a people,” she continues, “may be such as to segregate them from others, and thereby to preserve or even intensify their natural characteristics; or it may expose them to extraneous influences, to an infusion of new blood and new ideas, till their peculiarities are toned down, their distinctive features of dialect or national dress or provincial customs eliminated, and the people as a whole approach to the composite type of civilized humanity. A land shut off by mountains or sea from the rest of the world tends to develop a homogeneous people. . . . An easily accessible land is geographically hospitable to all newcomers, facilitates the mingling of peoples, the exchange of commodities and ideas. The amalgamation of races in such regions depends upon the similarity or diversity of the ethnic elements and the duration of the common occupation.”<sup>2</sup>

The remainder of the book is largely an elaboration of the general outline given in the first two chapters and indicates a breadth of vision, a wealth of material gleaned from numerous authorities, and a general grasp of all the factors that enter into social life and social progress, that is highly satisfactory. However potent a factor struggle and selection may be, even these, as Miss Semple has so clearly shown, are largely determined by environmental influences.

WILLIAM Z. RIPLEY (1867- )

*Race and Environment*

Professor Ripley's *Races in Europe* forms a fitting conclusion to this part of our discussion for it represents a synthesis of the views of those emphasizing the all-sufficiency of selection to explain race progress and those stressing the potency of physical environment. “Nature,” he says, “sets the life lines for the savage in climate; she determines his movements, stimulates or restrains his advance in culture by providing or withholding the materials necessary for such advance.”<sup>3</sup> His investigations based on

<sup>1</sup> *Influence of Geographic Environment*, p. 44.

<sup>2</sup> *Ibid.*, p. 45.

<sup>3</sup> *Races in Europe*, p. 10.

observations and measurements of more than 25,000,000 persons carried on by different authorities, including those by himself, have as one aim "to show the relation which has arisen between the geography of a country and the character of its people and its institutions," but more specifically to separate if possible the factors of "nature" and "nurture" in the racial composition and ethnic peculiarities of the peoples of Europe.

Race, with Professor Ripley, is not to be identified with political boundaries, language or culture,<sup>1</sup> but is to be determined by characters that are inheritable, such as shape of the head, face form, pigmentation, stature and shape of the nose, — characters now designated as Mendelian; but among these he holds that the head form is most permanent, so the best ultimate criterion. In considering the head form he says that no correlation has been discovered as yet between this or indeed between the absolute size of the head and intellectual capacity.<sup>2</sup> A map of the world showing the distribution of head forms indicates that a broad headed race occupies central Asia and a strip on the extreme north; a medium headed race, or a mixed people, the central and eastern part of Europe and nearly all of the Americas except the west, while a long-headed race occupies Africa, Australia, Melanesia, western and southern Europe and the extreme north of the new world.<sup>3</sup> This distribution coincides roughly with that of the racial divisions of Flower and Giddings<sup>4</sup> based on color of the skin.

In discussing the best criterion of race our author shows that pigmentation, though often correlated with head form, is more subject to environmental influences than the latter character,<sup>5</sup> so, too, stature, which is often an ontogenetic variation due to congestion of population, occupation, and insufficient nutrition; that head form is better, also, than color and form of the hair which seem to change with slight race mixture.<sup>6</sup>

The particular problem of the author, to analyze the racial composition of Europe, is especially difficult as this part of the

<sup>1</sup> *Races in Europe*, ch. I, pp. 214, 454 f.

<sup>2</sup> *Ibid.*, pp. 39 f.

<sup>3</sup> *Ibid.*, p. 42.

<sup>4</sup> *Principles of Sociology*, p. 231.

<sup>5</sup> *Races in Europe*, chs. IV and XXI.

<sup>6</sup> *Ibid.*, p. 461.

earth is the area of most frequent race migrations, race conflicts and race mixtures,<sup>1</sup> yet by means of the normal frequency curve used especially to show the cephalic index, our author concludes that there are at present three distinct races, though by no means pure, which he designates as the Teutonic, the Mediterranean and the Alpine.

The Teutonic race, occupying especially Scandinavia and Germany, is described as possessed of long head, long face, light hair, blue eyes and narrow, aquiline nose; the Alpine (Celtic) race as found in the Alpine highlands of central Europe, as of medium height and stocky in build, with round head, broad face, light chestnut hair, hazel-gray eyes and variable nose; while the Mediterranean race of Italy, Spain and Africa, is shown to be of medium height and slender build, with long head, long face, dark brown or black hair, dark eyes and rather broad nose.<sup>2</sup> He believes that the first and third stand in direct descent from the long-headed dwellers of Europe in the Pleistocene period as represented by the Neanderthal and Cro-Magnon skulls, but that they came originally from Africa, the Teutonic being a differentiation from the original now represented by the Mediterranean race, increased stature and increased pigmentation being due to environmental influences together with selection, especially artificial selection.<sup>3</sup> He believes the Alpine race to be connected with the round-headed race which invaded Europe from Asia in this early period, at first largely displacing the long-headed race, but afterwards, in turn, crowded back by the latter into the less desirable sections, as the mountain regions; the long-headed people now occupying the most advantageous portions with a tendency to city life, while the round-headed are essentially country dwellers.<sup>4</sup>

Professor Ripley considers not only the problem of race segregation and stratification in Europe as determined by anthropometric measurements but also the derivation of these races and their relation to language, nationality and culture. All the factors that sociologists have emphasized as causes of social progress find

<sup>1</sup> *Races in Europe*, pp. 107 ff.

<sup>2</sup> *Ibid.*, pp. 462 f.

<sup>3</sup> *Ibid.*, p. 121.

<sup>4</sup> *Ibid.*, pp. 335 f., chs. XVII and XX.

place in his discussion, such as geographical isolation,<sup>1</sup> social contact together with group struggle and selection,<sup>2</sup> migration,<sup>3</sup> direct and indirect environmental influence,<sup>4</sup> consciousness of kind,<sup>5</sup> economic conditions,<sup>6</sup> and social, sexual and artificial selection.<sup>7</sup>

Our author attacks the specific problem of environment *v.* race in explaining ethnic peculiarities and cultural products and concludes that environmental factors have been all too largely neglected by investigators in the past. "At times," he says, "they rise paramount to all other circumstances."<sup>8</sup> He shows, for example, how climate has determined the segregation of cotton mills about Lancashire; how such social phenomena as divorce, suicide and crime are the products of density of population, economic and cultural conditions, and these in turn of physical and social environment, rather than of race.<sup>9</sup> A favorable geographical environment encourages early marriages as in the case of Italy in contrast to Brittany;<sup>10</sup> it favors the development of village and city life with social contacts resulting in increased individualism, liberty often descending to license and vice and political radicalism, — yet withal, progress, whereas the peoples relegated to geographic isolation, with their purer family life and greater stability of character are conservative and non-progressive.

The phenomenon of the marvellous growth of cities during the past century is discussed with special reference to its effects on ethnic distribution. City dwellers are found on the whole to be shorter in stature, lighter in weight (especially in tenement districts), and also on the whole with a greater tendency to pigmentation than dwellers in the country.<sup>11</sup> These facts have given rise to the theory of "urban selection," — pigmentation being considered to have some relation to vital force.<sup>12</sup>

<sup>1</sup> *Races in Europe*, pp. 56, 74 f., 139, 141, 232, 529.

<sup>2</sup> *Ibid.*, pp. 1, 56.

<sup>3</sup> *Ibid.*, p. 16.

<sup>4</sup> *Ibid.*, Introduction, chs. XIX, XXI.

<sup>5</sup> *Ibid.*, p. 2.

<sup>6</sup> *Ibid.*, pp. 338, 475.

<sup>7</sup> *Ibid.*, pp. 49 f., 85 f., 89, 201 f., 292, 398 f.

<sup>8</sup> *Ibid.*, p. 514.

<sup>9</sup> *Ibid.*, pp. 520 ff.

<sup>10</sup> *Ibid.*, p. 533.

<sup>11</sup> *Ibid.*, pp. 551 f.

<sup>12</sup> *Ibid.*, p. 557.

The concluding chapter is given to a study of acclimatization in its relation to the problem of the original diversification of races from one parent stock, but especially in its bearing on the colonization of the tropics by the white race. He shows how complex is the question concerning the effect of climate on the human organism as when people migrate from temperate regions to the tropics, and enumerates several disturbing factors that must be eliminated before one can determine this effect, such as the natural change in habits of life in the line of intemperance and immorality that so frequently accompany army life; the effect of race-crossing, choice of foods, differences of occupation with indolence on the one hand and over-exertion on the other. He shows further how a discussion of the effect of climate on the human body must take into consideration the racial element and ethnic peculiarities, certain races being susceptible to certain diseases and immune to others. Having eliminated these disturbing elements our author concludes that "the physical elements of climate, ranged in the order of their importance, are humidity, heat, and lack of variety."<sup>1</sup>

Physical acclimatization approximating the adaptation of natives, he holds, is a process requiring generations and that ultimate racial adjustment to the tropics can be secured, if at all, only by the costly method of trial and selection or by the drift to those regions of individuals and races already by nature and mode of life adapted to such life conditions. He shows that much temporary advantage may be gained by hygienic precautions, but that this does not mean racial acclimatization, and concludes that true colonization of the tropics by the white race is impossible.<sup>2</sup>

As to the question of the original process of racial acclimatization and diversification, Professor Ripley holds that it was due to spontaneous variation and natural selection and possibly also to ontogenetic variations that somehow became fastened upon the race.<sup>3</sup>

The eminently scientific character of this work and the judicial temper evinced on every page make it apparently above adverse criticism. The various factors that enter into passive socio-

<sup>1</sup> *Races in Europe*, p. 571.    <sup>2</sup> *Ibid.*, p. 584.    <sup>3</sup> *Ibid.*, p. 587; cf. pp. 383 f.

physical adaptation are clearly set forth with suggestions of the potency of artificial selection and hygiene, — factors that belong to active adaptation.

This work we have so briefly reviewed takes us into the very heart of inductive sociology and might well introduce us at once to a review of the social philosophers who have emphasized the inductive method as applied to the whole social process but we must turn aside to consider some who have given their attention primarily to the problem of social philosophy as a whole, to the development of the concept of society as a psychological organism, and to an analysis of the socio-psychical factors in the development of civilization, — all these writers making considerable use of the deductive method.

PART III

PASSIVE SPIRITUAL ADAPTATION





## CHAPTER VII

### DEVELOPMENT OF THE CONCEPT OF SOCIETY AS AN ORGANISM

WE have noted the use of the organic analogy by Comte and Spencer and its exaggerated use by Lilienfeld. In this chapter we will consider the development of the concept, especially as related to our subject, in the social theories of Schäffle, Mackenzie, Le Bon and Durkheim, with some reference to other writers.<sup>1</sup>

In our discussion of Spencer we called attention to the very great emphasis placed by him on passive adaptation. In his thought society, meaning, usually, the sovereign group, is a quasi-biological organism, or "super-organism," subject, in its growth and decline, to the same mechanical laws as a biological organism. Almost no place was given by him to the concept of active adaptation. Lilienfeld, as we saw, brought into prominence the idea of social pathology and social therapeutics (a figurative term for active adaptation), although his reasoning was so largely deductive as to be of little scientific value. Those whom we are to consider in this chapter have made more use of the inductive and historical methods and have carried the discussion further into the realm of the psychical than did the earlier writers, bringing into prominence the thought of society as a psychical organism, thus preparing the way for greater emphasis on active adaptation.

ALBERT SCHÄFFLE (1831-1903)

#### *The Social Organism*

According to Barth, Schäffle made slight advance over Spencer in the use of the organic concept in several minor particulars: (1) as to the structure of society, Schäffle does not consider the individual to be the social unit in all social relations, but rather

<sup>1</sup> Barth discusses the use of this concept by Spencer, Lilienfeld, Schäffle, Fouillée, and Worms, *op. cit.*, ch. IV.

the family;<sup>1</sup> (2) he calls attention more than Spencer to the apparatus for the defence of the social body, and (3) he emphasizes the nature of the spiritual life of society and its media of expression and development.

As to the social process, our author goes beyond his predecessors in his discussion of the decline of social bodies, — the problem of mal-adaptation, — even to destruction, making some use of the terms evolution, transvolution and involution to describe the cycle of growth and decay. He goes further, too, in his distinction between types and stages of development. By the former he has in mind ethnological distinctions corresponding roughly to animal species, but characterized not only by physiological but also by mental and social differences; by the latter he has in mind various social groupings which he considers to represent stages of development.<sup>2</sup> Barth holds that he has not extended in any marked degree the social theories of his predecessors.<sup>3</sup> The careful reader of Schäffle, however, cannot fail to note a different atmosphere and an emphasis not found in Spencer on the psychological character of the “social body” and on purposive action.

Small characterizes the difference between these two authors as follows: “Spencer’s analysis affects one more like the disentangling of a mechanical puzzle, while there is more of the atmosphere of actual life in Schäffle’s description of the social body. The difference as I see it reduces to this: Spencer does not succeed in making his interpretation of society picture it as more than an *organism of mechanism*, Schäffle’s central conception of society is an *organization of work*.”<sup>4</sup> I should add, “directed by purposive intelligence.”<sup>5</sup>

<sup>1</sup> *Op. cit.*, pp. 138 f.

<sup>2</sup> Barth, p. 141, gives as Schäffle’s classification the following: (i) *Völkerschaft*, (ii) *ständische oder feudale Gesellschaft*, (iii) *bürgergemeinschaftliche Polis*, (iv) *Landesgemeinwesen*, (v) *Nationalgemeinwesen*.

<sup>3</sup> “So finden wir, bei Schäffle kein principielle Hinausgehen über Spencer. . . . Es ist ihm aber nicht bewusst geworden, das damit die Gesetzmässigkeit des tierischen Lebens, die biologische, verlassen wird, und eine ganz neue an ihre Stelle tritt,” — *ibid.*, p. 145.

<sup>4</sup> *General Sociology*, p. 167.

<sup>5</sup> “Der sociale Körper wirkt und lebte zwar durch Kräfte der anorganischen und der organischen Natur aber er *beherrscht diese Kräfte geistig und verwerthet sie*

To appreciate Schäffle's use of the organic concept as applied to society and especially the bearing of his teaching on our subject one must understand his philosophical approach. A follower of F. U. Lange and von Baer in his spiritual monism and so a positivist in his treatment of social phenomena from the point of view of science, he nevertheless makes place for the hyper-scientific world of values, — the realm of the aesthetic and religious.<sup>1</sup> Although making large use of the work of Fechner, Helmholtz and Wundt in physiological psychology, he repudiates all attempts to identify the two orders on the material side, and lays great stress on the fact of teleology in the social process, asserting that this fact gives warrant for belief in teleology in the world-order.<sup>2</sup>

With Nägeli *et al.*, he posits as a necessary assumption to the understanding of cosmic and especially of social evolution, an *entelechy* or life-force with a tendency to reach out and develop to ever higher forms of life.<sup>3</sup>

A follower of Darwin in his belief in natural selection at least as a powerful factor in organic evolution, he shows that in animal and human societies the individual is not the unit of struggle but the group, and that group life is characterized by mutual aid.<sup>4</sup> He holds that the law of natural selection operates very differently in social evolution for the groups are ever enlarging, and the struggle is not so much for existence as for kind of existence and is also between social ideals and institutions.<sup>5</sup>

technisch. Der Mechanismus, der Chemismus und das Spiel organischer Vorgänge werden im socialen Leben zu einer zweckbewussten geistig bewegten Physik erhoben. . . .

"Der sociale Körper folgt aber auch einer völlig eigenartigen, wenn gleich gesetzmäßigen Entwicklung. . . . Diese Entwicklung ist die Wirkung von in historischem Sinn constanten Motiven und Bedürfnissen und von eben solchen Naturvoraussetzungen. Sie ist nicht Ablauf eines mechanischen Uhrwerks. Gegenüber dem wunderbar sicheren und regelmässigen aber noch nicht genau erklärbaren Verlauf der Evolutions- und 'Involutions'-Erscheinungen organischer Leiber ist die sociale Entwicklung wesentlich Produkt der bewussten Triebe oder Beweggründe, die in jeder Generation des Volkes leben, jedoch unter dem Einfluss führender Geister und ihrer Ideen beharrlichen Neuerungen und Bereicherungen unterliegen," *op. cit.*, i, p. 4. Cf. also, pp. 9, 10, 12, 828, 831.

<sup>1</sup> *Bau und Leben*, i, pp. 5, 63, 66.

<sup>2</sup> *Ibid.*, ii, p. 20.

<sup>3</sup> *Ibid.*, ii, p. 23; cf. i, p. 104.

<sup>4</sup> *Ibid.*, ii, pp. 11, 25.

<sup>5</sup> *Ibid.*, ii, pp. 2, 29, 47. His theory of social development is summarized as follows (ii, p. 55): "Die fortschreitende Gesellschaftsbildung (Civilisation) ist das höchste

Schäffle wisely turns aside from the analogical reasoning of Haeckel and Lilienfeld formulated in their theory of "recapitulation" also from the theory of "division of labor" of the latter, and points to the possibility of studying the social process immediately, — "a process now going on before our very eyes." <sup>1</sup>

Accepting the principle of adaptation as the key to the understanding of biological evolution he makes large use of this concept for the understanding of social evolution. "Through the very nature of the widening struggle for existence and struggle of interests, which characterizes the co-operative labor of the social unity," he says, "is brought about that transformation of civilization which is in the line of the greatest possible perfectionment and so is in a specific sense a *development*. Struggle creates parties relatively best adapted for the conflict. Those organisms, persons, institutions (Gesellschafteseinrichtungen) that are relatively most perfect attain more or less exclusive worth while the enemies and rivals that are unadapted are suppressed or forced to an adaptation of a lower order (zu abweichenden Anpassung genöthigt werden). The best adapted (Passendere) attain development, transmissible goods (Ueberlieferung) and posterity." <sup>2</sup>

Ergebniss der vervollkommnenden Auslese der menschlichen Daseinskämpfe. Genauer gesagt — ist sie das unausbleibliche Produkt aller Daseins- und Interessenkämpfe, welche von den socialen Einheiten jeder Individualisierungsstufe theils unter sich, theils gegen die äussere Natur, mit den wachsenden Mitteln der menschlichen Geistes-, Körper- und Vermögensausstattung und innerhalb einer durch Recht und Sitte gesetzten Streitorganisation ausgekämpft, durch den Trieb individueller und collectiver Selbsterhaltung, durch den organischen Vermehrungstrieb, durch den Eigennuz, durch gemeinnützige Verbesserungsbestrebungen erweckt und in immer höherem Grade erneuert, um die Befriedigung nicht blos der sinnlichen Nothdurft, sondern mehr und mehr um ein steigendes Mass höherer materieller und ideeller Lebensansprüche geführt, durch Zufall, durch Spiel, durch äusseren und inneren Krieg, durch freien Austrag und durch vielgestaltige Urtheilsinstanzen des Wettstreites entschieden werden, und nothwendig dahin führen: dass *im Einzelnen* die relativ besten Anpassungen sowohl angeregt als zur Herrschaft, Ausbreitung und Ueberlieferung gebracht, dagegen die relativ schlechtesten Anpassungen, die Entartungen und fremdartigen Bildungen vernichtet, abgestossen, oder zu besserer Anpassung genöthigt werden, und dass *im Ganzen* ein wachsendes Mass ideeller und materieller Kräfte für die collective Führung des menschlichen Daseinskampfes sich anhäuft, dass immer mehr Gesellschaftsbildung, das heisst immer mehr Gliederung und Vereinigung der geistigen und physischen Arbeitskräfte, sowie der zuhörigen Güterausstattungen stattfindet."

<sup>1</sup> *Bau und Leben*, ii, pp. 33 f., 460.    <sup>2</sup> *Ibid.*, ii, p. 29; cf. also pp. 10, 31, 166.

This principle of adaptation is with him the mediator between the cosmic spirit and the material world-order; i. e., the spirit is limited in its manifestation by bonds imposed by the material.<sup>1</sup>

With this glimpse into the background of his social philosophy we can understand better his use of the organic concept as applied to society. "At the very summit of the phenomena of life on our earth," he says in the opening paragraph of his *Bau und Leben*, "stands human society, — the social body and its private and national institutions. Built up out of matter, and impelled by forces of the inorganic and organic world, it is nevertheless a living body of a peculiar kind. Human or civil society, a far higher structure than the societies of animals, is a purely spiritual result, an indivisible social life of organized individuals wrought out through the force of ideas and achievements of art."<sup>2</sup>

It is true that Schäffle does not make it as plain as we should desire just what is included in this concept "social body." In the preface to *Bau und Leben* he quotes with seeming approval Goethe, Paschal and Comte who conceived all past generations of men as forming an organic whole; in some places the goal of the social process includes all humanity; in other places he seems to have in mind primarily the sovereign state, and again the term is used as synonymous with a civilization; but his general line of argument would necessitate the limitation of the term to such a group as possesses real psychical unity.<sup>3</sup> It is thus a very elastic term. The one thing Schäffle seems to be groping after is a conception developed later by Le Bon and Durkheim of a psychical somewhat over against the individual which moulds his life, into which he is assimilated and which he in turn modifies, — and this unity organized and active, expressing itself in social institutions.<sup>4</sup>

The goal of the social process is "the coming to fulfilment" of the process itself,—but this is not given definite content. With increasing development comes increasing differentiation and

<sup>1</sup> *Bau und Leben*, ii, p. 31.

<sup>2</sup> Cf. also, i, pp. 9, 10, 12, 828, 831.

<sup>3</sup> *Ibid.*, Introduction, esp. pp. 6, 7; cf. i, pp. 316 f.; ii, pp. 464 f.; cf. Jacobs, *German Sociology*, pp. 18 f.

<sup>4</sup> *Bau und Leben*, i, p. 203; ii, pp. 203 f.

integration of that which is taken as the social unity.<sup>1</sup> This means division of labor and increasing dissimilarity in the parts which make up the "social body" and in the functions performed by them.

The goal for each individual should be to find out the place in the social body for which he is best adapted and fit himself for that place.<sup>2</sup> The function of government is considered to be primarily to improve the condition of the backward members of the social body, and to make them *fit* members, to organize for social efficiency and well-being and to correct pathological conditions.<sup>3</sup> In this task leadership rests primarily with the élite.<sup>4</sup>

In his emphasis on individual and social *purposeful* activity, then, we have the chief difference between Schäffle and Spencer, in this approximating more nearly to Comte and Lilienfeld. He goes far beyond the former, however, in his analysis both of the structure and development of the social body, and beyond the latter in his use of inductive rather than merely analogical reasoning with conclusions proportionately more scientific and satisfactory.

J. S. MACKENZIE (1860- )

*An Idealistic Interpretation of Social Progress*

Professor Mackenzie has not done so much to develop the organic concept as to analyze its meaning and rationalize its use. His approach to social philosophy is through Hegelianism of the Right and the Hegelian idealism and dialectic are evident at many points.

Like Spencer and Schäffle he believes in an inner principle of development but unlike them he repudiates the attempt to reduce this to terms of positive science. No one, perhaps, has criticized more cogently than he that form of utilitarianism which, as with Bentham, tries to evaluate pleasures and pains quantitatively, but he fails to appreciate the fact that there may be a utilitarianism which has an objective standard entirely different from the one criticized.

<sup>1</sup> *Bau und Leben*, ii, pp. 440 f.

<sup>2</sup> *Ibid.*, i, p. 202.

<sup>3</sup> *Ibid.*, i, p. 559; ii, pp. 194 f.

<sup>4</sup> *Ibid.*, i, p. 435.

Three of his analyses are of special importance for our discussion: that of different kinds of unity, that of different meanings of self, and that of different goals of social endeavor.

I. *Kinds of Unity*.—The totality of the world, or any particular object in the world, according to Mackenzie, may be regarded: (1) as a simple unity, in which there is no real difference of parts; or (2) as a mere collection of differences, in which there is no real unity; or as a system in which there is both unity and difference. And if it is thought of as a system, it may be regarded either (3) as a system in which the parts have an absolutely independent existence, though they are subordinated to the whole to which they belong; or (4) as a system in which the parts are deprived of their independence by being transformed and swallowed up in the whole; or, finally, as a system in which the parts have a certain relative independence, but an independence which is conditioned throughout by its relation to the system, — an independence, in short, which is not freedom *from* the system, but freedom *in and through it*.<sup>1</sup>

Mackenzie goes on to show that the first might be typified by a single crystal, the second by a heap of stones or bed of flowers, the third by the solar system, the fourth by any chemical combination and the fifth by the life of a single plant.

Our author shows how these five different views of unity are reflected in different philosophical systems, in various ways of interpreting human freedom, in theology, in one's conception of justice and finally in endeavors to understand society.<sup>2</sup> He defines an organism as "a whole whose parts are intrinsically related to it, which develops from within and has reference to an end which is involved in its own nature,"<sup>3</sup> and shows that society corresponds to this kind of unity rather than to any of the other four mentioned.

Its parts are intrinsically related to it, for the rational nature of the beings who compose it is entirely dependent for its being and continuance on the existence of certain social relations. It develops from within; for its growth consists simply in the unfolding of the rational nature of each of its individual members, — that rational nature being, moreover, always essentially relative

<sup>1</sup> *Introduction to Social Philosophy*, p. 129.

<sup>2</sup> *Ibid.*, pp. 131 f.

<sup>3</sup> *Ibid.*, p. 148.

to the nature of the whole society in which it develops. It has reference to an end which is involved in its own nature; for the end of society is to preserve the life and to secure the highest life of its individual members, — this highest life, moreover, consisting not in the attainment of anything external either to the individuals or to their society but to the perfect realization of their own rational nature, which can be attained only in a perfect social life.<sup>1</sup>

This interpretation of the organic nature of society can be understood only in the light of his philosophical presuppositions developed in the first three chapters of his *Social Philosophy* which are essentially Hegelian. The chief difficulty is that it is vague and devoid of specific content.

II. *Meanings of Self*. — In his analysis of the different meanings of *self*, objects are considered to have *selfhood* under the following conditions, arranged in a progressive series: (1) When there is some kind of unity and identity, though given it by an apperceiving mind, as when we speak of a river that empties *itself* into the sea. A house, book, work of art has this kind of selfhood; (2) where there is not only this kind of apperceived unity but where the object must be so regarded in order to be understood as in the case of a vegetable organism; (3) where the object has some degree of self-consciousness mediated, however vaguely, through sensations of pleasure or pain, as in the case of an animal: "Such a being is a unity for *itself*, though not conscious of itself as a unity"; (4) where the object is conscious of itself as a unity, reflecting on its own life and recognizing itself as one throughout all its changes; and finally, (5) where the object is conscious of itself as a unity and part of a unitary world, as in the case of man at least potentially: "He is aware of his individual life not as a microcosm in a chaos, but as a microcosm in a macrocosm, to the objective unity of which his individual life as well as everything else is referred."<sup>2</sup>

Mackenzie does not enter into the question current now among social psychologists as to the meaning of self as applied to the social organism, and his whole discussion leaves us in doubt as to what his position would be, for while he emphasizes the individual as the sociological unit, society existing only for the well-being of

<sup>1</sup> *Introduction to Social Philosophy*, p. 238.

<sup>2</sup> *Ibid.*, pp. 161 f.



individuals,<sup>1</sup> he holds that the individual apart from society is an abstraction.<sup>2</sup> He does, however, emphasize the psychical unity of society, considering persons or groups who are unassimilated as instruments of a civilization of which they do not partake.<sup>3</sup>

III. *Social Goals*.—In discussing possible ends to which the world-order is tending he holds that it must be considered in terms of the well-being of individuals and discusses various ways of interpreting individual well-being as in terms of knowing, feeling, willing, in some combination of these, or finally as a realization of our conscious nature as a whole.<sup>4</sup> His conclusion is that the end is in the fulfilment of certain wants of our nature rather than in the pleasure which ensues upon their satisfaction.<sup>5</sup> This brings his teaching into harmony with the doctrine of adaptation, for our real needs are such as make for largeness and fullness of life and this depends upon our being adapted to our environment and especially upon our mastery of our environment, as our author holds.<sup>6</sup>

Mackenzie divides these wants or needs into three classes: (1) vegetable, (2) those arising from our organic or animal sensations, and (3) those due to reason.<sup>7</sup> He shows that the end cannot be merely either (1) or (2) or both combined, so must be (3), and this requires that we view our world as issuing from intelligence of which our own and that of our fellow-men are parts, and that we make ourselves at home in this world.<sup>8</sup> He concludes as follows:—

<sup>1</sup> *Introduction to Social Philosophy*, pp. 66, 159.

<sup>2</sup> *Ibid.*, pp. 120, 180; cf. pp. 131, 136.

<sup>3</sup> *Ibid.*, p. 156.

<sup>4</sup> *Ibid.*, chs. IV and V.

<sup>5</sup> *Ibid.*, p. 228.

<sup>6</sup> "Men were first exploited by men; then they were exploited by things; the problem now is to combine men together that they may exploit things," *ibid.*, p. 107.

<sup>7</sup> *Ibid.*, p. 228.

<sup>8</sup> "We must not only be able to *bring* our world into a certain intelligible order, but we must also be able to see it *issuing out* of an intelligible order. Such an intelligible world would exist for us if the world of our experience were not merely presented to our intelligence, but arose from our intelligence, i. e., if we created our world as well as perceived it, and such a world would equally exist for us if we saw it as issuing from the unity of some other intelligence than our own. It would then appear not merely as a collection of facts which is reduced to system, but as a collection which flows from a system, and which is consequently intelligible from beginning to end. . . . Now such an intelligible world is presented to us

Here, then, we seem at last to have found out what the true nature of man's end is; and we see that that end is by its very nature a social one. It is clear, too, that the end which we have now defined includes everything which "we divine" as belonging to the highest good. It includes, indeed, every one of the ends which have been previously enumerated. It includes what we have described as the objective ends, — the realization of reason, order and beauty in the world; for the realization of them is part of our work in making our world intelligible and clear to ourselves. It includes also the realization of life; for it is the fulfilment of that towards which our lives as rational beings strive; and in the fulfilment of this for ourselves, there is involved also the realization of the lives of other intelligent beings; since it is only in the fulfilment of their intelligent nature that our own can receive fulfilment.<sup>1</sup>

The social problem, as he sees it, is to discover the form of social union in which, under given conditions, the progress will be most rapid and most secure towards that good which we must regard as the ultimate end.<sup>2</sup> He holds that, though diversity of interests leads to conflict, ultimately the good of the individual and society are identical.<sup>3</sup>

In his practical program of meliorism, Mackenzie emphasizes individual culture, the conquest of nature and right social relations, all these introducing what we have termed *active adaptation*.<sup>4</sup>

The need of social control is due to the fact that progress towards a more complete mastery of nature is not necessarily a progress towards more complete happiness for the following reasons: (1) As the means of material well-being increase, population also increases, and the struggle for existence becomes keener; (2) Human nature is not sufficiently plastic to adapt itself continuously to the changing conditions of existence; (3) Industrial progress brings with it an increasing freedom of competition, and this adds to the keenness of the struggle; (4) Industrial progress tends to reduce the working classes more and more to the condition of a proletariat, and in that way militates directly against the happiness of the great mass of population.<sup>5</sup>

by the lives of our fellow-men and in the works which they perform. . . . No attainment of the ideal of our rational nature is conceivable, except by our being able to see the world as a system of intelligent beings who are mutually worlds for each other. . . . It is only in the lives of other human beings that we find a world in which we can be at home. The society of other human beings is not merely a means of bringing our own rational nature to clearness, but it is the only object in relation to which such clearness can be attained," *ibid.*, pp. 231-233.

<sup>1</sup> *Introduction to Social Philosophy*, p. 234.

<sup>2</sup> *Ibid.*, p. 237.

<sup>3</sup> *Ibid.*, p. 236.

<sup>4</sup> *Ibid.*, p. 241.

<sup>5</sup> *Ibid.*, p. 307.

He finds communism and socialism entirely inadequate forms of social organization and rule by an aristocracy of talent at present impracticable so is driven back to the ideal of *Fraternity* understanding by that "the recognition that the true ideal must be founded rather on the notion of a readjustment of the hearts of the citizens."<sup>1</sup>

This introduces a conception of adaptation which may be termed active moral, i. e., the effort to adjust our lives progressively to our ever-advancing ideal, and to bring our fellow-men also into harmony with that ideal.

GUSTAV LE BON (1841- )

*The Psychology of Peoples*

We have considered the development of the concept of organism as applied to society in the social theories of Schäffle and Mackenzie, the one making his approach largely through biology, the other through philosophy, and both emphasizing the fact that the bond of social union is primarily psychical, the former bringing into prominence common ideals, symbols, traditions and the expression of these in institutions, the other, the rational needs of individuals; but we are still left with the vague social goal of self-realization, either of individuals as with Mackenzie or of the world-force as with Schäffle. We turn now to some writers who have endeavored to work out a clear concept of society as a psychical organism.

Le Bon in his *Psychology of Peoples* summarizes the conclusions of elaborate investigations carried on by him covering a period of years and published in several volumes, dealing with the fundamental characteristics of various peoples considered as psychical unities. He shows how impossible is a racial classification based on descent, and how unsatisfactory is one based on physiological characteristics. A race as he conceives it, is primarily a social group which by a common physical and psychical heredity develops a distinct character or "soul." In early historical times this soul did not extend beyond the family,

<sup>1</sup> *Introduction to Social Philosophy*, p. 290.

tribe, city (as in Greece) or village (as in India). More recently it has expanded to include the state or nation.<sup>1</sup>

The fundamental characteristics which differentiate races, he holds, are few in number and practically unchangeable. The accessory characteristics, however, due to environment, circumstances or education are changed with comparative ease.<sup>2</sup>

Races are classified as primitive, inferior, average and superior, the chief criterion of superiority being "aptitude for dominating their reflex impulses."<sup>3</sup> From primitive to superior civilization there is progressive differentiation of individuals, sexes and races, though among superior races there are "no inherent differences in men of one race." The only difference is that "circumstances have called out latent possibilities," as in the case of Robespierre, Fouquier-Tinville and Saint Just.<sup>4</sup>

"Character," says Le Bon, "is formed by the combination in varying proportions, of the different elements which psychologists are accustomed at the present day to designate by the name of sentiments . . . [such as] perseverance, energy, power of self-control, faculties more or less dependent on the will and morality."<sup>5</sup> "The intellectual qualities," he holds, "are susceptible of being slightly modified by education, those of character almost wholly escape its influence," — and this latter result comes only in the case of neutral natures, i. e., those "whose will is almost non-existent."<sup>6</sup> "The character of a people and not its intelligence determines its historical evolution and governs its destiny."<sup>7</sup> Because of the different characters of peoples taken as a whole, arise misunderstandings and wars, subjugation and social stratification resulting in division of labor. Owing to this stratification and the exploitation of the masses, a people comes to have a form like a pyramid with the élite at the apex, "an exceedingly restricted group as compared with the rest of the population, but the only group that determines the rank of a country in the intellectual scale of civilization."<sup>8</sup>

<sup>1</sup> *Psychology of Peoples*, p. 14.    <sup>5</sup> *Ibid.*, p. 31. Cf. Comte's use of term "heart."

<sup>2</sup> *Ibid.*, p. 19.

<sup>6</sup> *Ibid.*, p. 32.

<sup>3</sup> *Ibid.*, p. 30.

<sup>7</sup> *Ibid.*, p. 34.

<sup>4</sup> *Ibid.*, p. 20.

<sup>8</sup> *Ibid.*, pp. 35-42, 199 f.

The only way the soul of a people can be radically changed, our author asserts, is by cross-breeding, and he points out the danger that threatens America in the hordes of emigrants going to her shores; but the bad effects of cross-breeding are not considered by Le Bon to be physiological so much as socio-psychical.<sup>1</sup> Such a period of transition is always one of internal struggle and only at such a time is environment a potent factor in the transformation of the racial type.<sup>2</sup>

Le Bon shows how social institutions are a manifestation of the invisible soul of a people and how impossible it is to change these institutions except through a change in the soul.<sup>3</sup> He reaches the conclusion that the elements which, philosophically speaking, are inferior (e. g., military power) are the most important from the social point of view. "If the laws of the future," he says, "are to be those of the past, it may be said that to have attained to too high a degree of intelligence and culture is what is most harmful to a people. People perish as soon as the qualities of character which form the ground work of their soul begin to decline, and these qualities decline as soon as the civilization and intelligence of a people reach a high level";<sup>4</sup>—but he does not analyze the causes of the decline in the character of a nation nor does he show the reason why this leads to their conquest by a barbarous people.

Our author goes on to consider how the history of nations is a consequence of their character, illustrating this truth especially from politics, and shows how France today, as for generations, stands for state control, in contrast with the English demand for social endeavor by voluntary co-operation.<sup>5</sup>

In book IV, Le Bon discusses the question of the modification of the psychological characteristics of races and shows how this is brought about by a slow process of progressive adaptation as a result of the pressure of wants, struggle for life, action of certain

<sup>1</sup> *Psychology of Peoples*, pp. 52 f.

<sup>2</sup> *Ibid.*, p. 54.

<sup>3</sup> *Ibid.*, pp. 64 ff.

<sup>4</sup> *Ibid.*, p. 80. Cf. pp. 55, 193, 213, where he shows how the soul of a people may be destroyed.

<sup>5</sup> *Ibid.*, pp. 130 ff. His forecast that there would be little progress in state control in England and America has been negated by recent developments.

elements in the environment (especially in new races), progress of the sciences and industry, by education, beliefs, and in many other ways. "Ideas," he says, "can have no real action on the soul of peoples until, as the consequence of a very slow elaboration, they have descended from the mobile regions of thought to that stable and unconscious region of the sentiments in which the motives of our actions are elaborated. They then become elements of character and may influence conduct."<sup>1</sup>

As to the mechanism of propagation of new ideas, it is held to be by innovation on the part of the élite and imitation on the part of the masses,<sup>2</sup> under some conditions taking a form analogous to contagion.<sup>3</sup> Religious beliefs, he holds, have always constituted the most important element of the life of peoples.<sup>4</sup>

Le Bon makes verbal connection with our general subject in these words:—

The history of civilization is . . . composed of slow adaptations, of slight successive transformations. . . . The brain cells do not assimilate in a day what it has taken centuries to create, and what is adapted to the sentiments and needs of organisms that differ from one another. Only slow hereditary accumulations allow of such assimilation;<sup>5</sup>

but his whole discussion is an elaboration of the concept of psychical unity applied to the group, this unity being the progressive result of the law of adaptation, the individual member forced to adapt himself to the group and the group-soul progressively changing in response to new needs until it has attained its full growth when there ensues a period of decline.

Thus with the progress of social evolution and in accordance with the law of adaptation we find different social groupings so united by a common physiological and psychological heritage, so bound together by common interests and ideals, and responding so alike to a common stimulus that we may well speak of such groups as having a "soul."<sup>6</sup> Though in describing the soul of any particular group whether city or state we may use the normal frequency curve representing all the people, it is the variation

<sup>1</sup> *Psychology of Peoples*, p. 168.

<sup>2</sup> *Ibid.*, p. 174.

<sup>3</sup> Developed in his *Crowds*.

<sup>4</sup> *Psychology of Peoples*, p. 190.

<sup>5</sup> *Ibid.*, p. 96.

<sup>6</sup> *Ibid.*, pp. 6, 59, 146, 171.

representing the élite that really characterizes the group.<sup>1</sup> The mass are mere imitators. This unity thinks as one, feels as one, wills as one. Such unity and homogeneity, he holds, is essential to greatness, hence is imperilled by large scale immigration.<sup>2</sup>

Le Bon is open to criticism chiefly in that no group or race is in fact such a psychical unity as he portrays, and containing as each group does individuals representing all stages of culture, a possible opening is afforded for foreign influences of all sorts. Tarde has been his most successful critic in this particular expressing himself thus: —

We must, from now on, no doubt, abandon such artificial differences as the philosophy of history established between successive peoples. . . . It is no longer allowable to interpret these much abused expressions "the genius of a people or race," "the genius of a language," or "the genius of a religion," in the way that some of our predecessors, including even Renan and Taine, understood them. These embodiments of collective character . . . were endowed with a fictitious personal identity, which was, however, rather indefinite. Certain predispositions, supposed to be invincible, for some particular grammatical types, religious conceptions, or governmental forms, were freely attributed to them. On the other hand, they were supposed to have an insuperable repugnance to borrowing conceptions or institutions from certain of their rivals. . . . Sooner or later, one must . . . recognize that the genius of a people or race, instead of being a factor superior to and dominating the characters of the individuals . . . is simply a convenient label, or impersonal synthesis, of these individual characteristics; the latter alone are real, effective, and ever in activity. . . . The impersonal, collective character is thus the product rather than the producer of the infinitely numerous individual characters.<sup>3</sup>

We must grant to Le Bon, however, credit for his exposition of an important truth needed at the time to offset the over-emphasis being laid on the concept of society as a biological organism carried so far especially by Schäffle and Liliensfeld. There is a "togetherness" in every social group. There is a certain community of thought and life. Working for ages this communal life has no doubt registered its effects on the physical organism including brain and nervous system. To him credit is due, also, for placing in strong light the truth that every individual is born as a part of this "soul" and that he must harmonize his life with

<sup>1</sup> *Psychology of Peoples*, p. 43.

<sup>2</sup> *Ibid.*, p. 13.

<sup>3</sup> *Social Laws* (Warren), pp. 49 ff.

it; further, that social progress is advanced by the contact and conflict of social "souls" by processes of imitation, assimilation, conflict and survival.

EMILE DURKHEIM (1858- )

*Social Realism*

Durkheim's social philosophy is founded on Comte's positivism modified somewhat by Espinas' social realism, and the Volkswirtschaftslehre of Wagner and Schmoller and the psychological teachings of Wundt.<sup>1</sup> He makes advance on the authors previously considered in two particulars: first, in his elaboration of the thesis that society has an objective reality, *sui generis*, and second, that this solidarity is on the one hand mechanical, based chiefly on consciousness of kind and expressed in repressive reactions against the individual, and on the other hand organic, based on division of labor and consciousness of supplementary difference and expressed in family life, friendship, co-operative endeavor and co-operative right.

1. *Society as a Reality, sui generis.* This concept had already been developed by Comte, Schäffle, Espinas, Wagner, Schmoller, *et al.*, and was being developed by Le Bon. Comte, however, considered only society, not societies; Schäffle connected sociology immediately with biology and individual psychology, making the individual, for the most part, the sociological unit; Espinas was interested chiefly in animal societies and greatly exaggerated the conscious social activity manifested in lower orders and approached more nearly than Durkheim to the crass realism of mediaeval philosophers. The German school was interested chiefly in the production of wealth from the nationalistic point of view together with the historical discussion of the subject, while Le Bon was busied with a study of the phenomena of crowds, and in the socio-psychical characters of social groups. Durkheim's approach is purely sociological. His aim is to show that society is not merely a psychical organism but one that is socio-psychical, governed by laws different from those of individual psychology,

<sup>1</sup> Deploige, *Le Confit de la Morale et de la Sociologie*, pp. 127, 128.



hence the need of a special department of investigation with its own terminology, — viz., sociology. This interest is revealed in his *Règles de la méthode Sociologique*, published in 1894,<sup>1</sup> in which we find the thesis that “society is not a mere sum of individuals, but the system formed by their association represents a specific reality which has its own characters.”<sup>2</sup> Yet Durkheim admits that there is no objective substratum of this collective consciousness corresponding to the physiological substratum of individual consciousness.

The totality of the beliefs and sentiments common to the average members of a social group form a definite system which has its own life. One can call it *the collective or common consciousness*. To be sure it does not have a unique organ for its substratum, for it is by definition, diffused throughout the extent of the society; but nevertheless it has specific characters which make it a distinct reality. It is independent of the particular conditions in which individuals happen to be placed; they pass, it remains. It is the same at the north and in the middle sections, in the large cities and in the small, in the different professions. Likewise it does not change with each generation but on the contrary unites them. It is then something different from particular consciousness although it is realized only through individuals. It is the psychic type of society, — a type which has its own properties, conditions of existence, mode of development, just as individuals have, although of a different kind. By virtue of this it has a right to be designated by a special word.<sup>3</sup>

While the above is true in a certain general sense of a sovereign group or “people,” — a conception elaborated by Le Bon, — it is also true and more specifically so, according to our author, of smaller social groupings within the state, as the family and professions, and of these at particular times.<sup>4</sup> “The study of these social solidarities,” he holds, “is the special province of sociology.”<sup>5</sup>

In this conception we are getting away from the individual approach to sociology as made by Spencer,<sup>6</sup> Schäffle and Mackenzie to emphasize the reality of the group over against the

<sup>1</sup> Cf. Deploige, *op. cit.*, pp. 156 f.

<sup>2</sup> *Règles*, p. 127, quoted by Deploige, *op. cit.*, p. 157.

<sup>3</sup> *De la Division du Travail Social*, p. 84.

<sup>4</sup> “Ce qui existe et vit réellement, ce sont les formes particulières de la solidarité, la solidarité domestique, la solidarité professionnelle, la solidarité nationale, celle d’hier, celle d’aujourd’hui, etc. Chacune a sa nature propre.” — *Ibid.*, p. 69.

<sup>5</sup> *Ibid.*, p. 69.

<sup>6</sup> *Ibid.*, p. 382.

individual, prior to the individual and making him what he is, — in this going back to Comte only with refinements. That is, Durkheim gives specific content to the concept of society as a socio-psychical organism: it is the psychical somewhat over against the individual which forms that particular spiritual environment into which he is born and which moulds his life. This environment, moreover, is not one but multiple. The individual is born into and moulded by the psychic somewhat represented by his particular family, later by that of the school he attends, later still by that of his vocational associations. Then there is the specific socio-psychic moulding power of his community and state.

2. *The Nature of Social Solidarity.*— This social solidarity, according to our author, is of two kinds, mechanical and organic. His purpose in *De la Division du Travail Social* is to work out a positive ethics and in order to have an objective “common to all,” — an object for scientific investigation, — all phenomena of the inner life of individuals must be correlated to objective expressions. The social consciousness expresses itself in laws, institutions, etc., and these are of a nature to be studied scientifically. The solidarity of society based on similarities or “consciousness of kind” is expressed in mores and crystallized primarily in “repressive right.” “The bond of social solidarity to which repressive right corresponds is that whose rupture constitutes crime. . . . One knows what the bond is, then, by knowing the particular crime which is considered most important. . . . The essential characters of crime are those which are found wherever there is crime whatever may be the social type. Now the only characters which are or have been recognized as common to all are the following: (1) crime clashes with the sentiments which are possessed by all normal individuals of the society under consideration; (2) these sentiments are strong; (3) they are definite. Crime, then, is the act which clashes with the strong and definite states of collective consciousness.”<sup>1</sup> The difference between the immoral act and the crime, he holds, is merely that the former violates sentiments diffused in individuals throughout

<sup>1</sup> *De la Division du Travail Social*, Table of Contents, p. 462.

society whereas the latter violates those sentiments held so generally and so strongly that the group reacts as a unit. He shows that crime cannot be explained wholly on the basis of disutility because many acts are tolerated which are far more disuseful than many which are regarded as crimes; yet his discussion shows that the principle of utility is after all of great importance.<sup>1</sup>

The social reaction expressed in repressive right is called mechanical for it corresponds to the instinctive reactions of biological organisms against irritants. The object of the reaction is to be free from the irritant, and on the whole the reaction of society against crime, though largely instinctive and irrational, is useful.<sup>2</sup> This mechanical solidarity expressed in repressive right is especially characteristic of primitive societies, the determination of crime and punishment among higher societies having a more rational basis,<sup>3</sup> though even here the function of punishment is to conserve the feeling of social solidarity rather than reform the criminal.<sup>4</sup> "Every strong state of consciousness," he says, "is a source of life; it is an essential factor of our general vitality. As a result, everything which tends to weaken it diminishes and depresses us. . . . It is inevitable then that we should react vigorously against any cause which threatens such diminution; that we arouse ourselves to remove it in order that we may maintain the integrity of consciousness."<sup>5</sup> This is as true of social as of individual consciousness.<sup>6</sup>

Durkheim explains the quasi-religious character of criminal procedure (*le droit pénal*) as due to the fact that the sentiment of vengeance expressed in passional reaction against the criminal is felt by each member of society yet not as a sentiment having personal origin or reference but rather as an echo of something

<sup>1</sup> No one asserts that the social struggle is so keen as to eliminate everything disuseful; yet on the whole and in the long run social consciousness is able to determine and does determine the socially disuseful and the society that fails to determine its crimes on this basis is on the road to destruction. Cf. Hall, *Crime in its Relation to Social Progress*. This seems to be Durkheim's position. Cf. *De la Division du Travail Social*, pp. 87 f., 114 f.

<sup>2</sup> *Ibid.*, pp. 89 ff.

<sup>3</sup> *Ibid.*, pp. 91 f.

<sup>4</sup> *Ibid.*, pp. 94 f.

<sup>5</sup> *Ibid.*, p. 103.

<sup>6</sup> *Ibid.*, pp. 109, 114.

from without and this something without, — which is in fact the collective consciousness, — is conceived as a superior power, real or ideal. This conception, though natural and necessary, is nevertheless illusory according to our author.<sup>1</sup>

This mechanical social solidarity, expressing itself in repressive right and punishment, is negative, but there is a positive social solidarity which expresses itself in co-operation, in division of labor, and co-operative law having as its psychological correlate the consciousness of supplementary difference.

This elaboration of the concept of organic solidarity based on division of labor and consciousness of supplementary difference though having antecedents in Comte and Bain, is the one great contribution of Durkheim and supplements in a much-needed way the concept of consciousness of kind, the corner-stone of Giddings' system.

The function of the division of labor is not to produce civilization, he holds, but to give birth to groups which, without it, would not exist.

It is possible that the economic utility of division of labor counts for something in this result but in any case its social value far exceeds the sphere of economic interests, for it results in the establishment of a social and moral order *sui generis*. Individuals are bound together who without it would be independent. In place of developing separately they unite in their efforts. They are *solidare* and with a solidarity which does not reveal itself merely in the brief moments of exchange of services but extends much further, as for example in conjugal solidarity among modern nations.<sup>2</sup>

This division of labor gives rise to "consciousness of supplementary difference" which has increasing importance with advancing civilization. Durkheim finds biological and anthropological basis for this as well as economic and psychological. Practically the only functional difference between the sexes at first, he holds, was that due to sex, and in this, too, we have the physiological basis of consciousness of supplementary difference; but with division of labor and functional differentiations came increasing structural changes, and *pari passu* increasing psychological, economic and social differentiations making ever greater opportunity for the play of the attractive force based on

<sup>1</sup> *De la Division du Travail Social*, pp. 107, 108.

<sup>2</sup> *Ibid.*, p. 63.

consciousness of supplementary difference. The result of this process has been ever increasing organic solidarity in societies.

One of the strongest proofs of his position he finds in the decrease of mechanical solidarity and increase of organic solidarity as revealed in the decrease of repressive rights and criminal laws and increase of co-operative rights and laws.<sup>1</sup>

The social ideal is a society where the division of labor produces such a condition that social inequalities express natural inequalities. Under such *normal* conditions we have the greatest possible individual and social well-being.

The only cause which determines the manner by which work is divided is diversity of capacity. By reason of this the division is made on this basis. Thus there is realized of itself a harmony between the constitution of each individual and his condition. One may say that this is not always sufficient to content men; that there are those whose desires exceed their abilities. It is true but such cases are exceptions not the rule. Normally man finds happiness in filling his natural place in society; his needs are in correspondence with his means. Thus in the organism each organ claims only that amount of aliment proportionate to its dignity.<sup>2</sup>

Most, I think, would say that this was the *ideal* rather than the *normally actual*. But even as an ideal it is suggestive, and as the disparity between the actual and the ideal is the background for individual and social telic endeavor, we have in this condition the chief sphere for the process of active as against passive adaptation. And indeed Durkheim recognizes this but considers as normal what we should term ideal and as abnormal what statistics by use of a frequency curve would doubtless show to be *normal*. He seems to have been misled by Comte's theory of society as a developing personality, by the general organic analogy and by Galton's theory of natural ability. The law of adaptation does not work so rigidly in social evolution at present as to bring about the survival of those societies only where division of labor is based on natural capacity to the degree assumed by our author. Indeed, as we have seen, we have no data available which afford proof of such differences in ability as assumed by Galton and Durkheim.

<sup>1</sup> *De la Division du Travail Social*, ch. V.

<sup>2</sup> *Ibid.*, pp. 421, 422.

Durkheim recognizes that society by relementation must furnish equality of opportunity for all and prevent that injustice which is the result of external restraint based on any other principle than that of ability. But society must go further than he suggests. It must train its members to perform those functions most needed by society, and when the need of the group is made the standard of the value of the individual to the group we will have to change the current conception of natural capacity and ability.

While indebted to Durkheim for his elaboration of the concept of social solidarity based on consciousness of kind and expressed in repressive right, we are more indebted to him for his insistence that consciousness of supplementary difference is both a cause and a result of division of labor, and that division of labor is both a cause and result of social solidarity.<sup>1</sup> Though he holds that this social solidarity and social consciousness are objective and real with laws different from those of biology or individual-psychology, yet he recognizes that it has no organic substratum corresponding to that of individual consciousness.

Fouillée and Le Bon have been, perhaps, among the ablest critics of this social realism, as it has been called,<sup>2</sup> but out of the controversy has come the truth now generally recognized that there is a psychical somewhat over against the individual which determines his life at least in general outline. This "somewhat" may be organized as a fraternity, church, or state, but in any case it is the great moulding and assimilating force in society. As in each organization there is need of division of labor, and as along with consciousness of kind man has a consciousness of supplementary difference, so in each organization we find diversity of capacity and temperament yet fused into one whole, made the stronger, usually, by the very fact of these differences.

Now every such "unity" is subject to the general law of adaptation. Not only does it react passively to its social environment, but to succeed in the highest degree it must *take thought*.

<sup>1</sup> For an opposite view, see Taussig, *Principles of Economics*, i, p. 38.

<sup>2</sup> Yet there is practically no difference between the fundamental conception of Durkheim and his critics. Cf. Fouillée, *Psychologie du peuple français*, pp. 10 f.

It must secure inner cohesion and strength in accordance with the principles elaborated by Durkheim *et al.*, and must have as its ideal that function in the larger whole for which it is adapted. It must, too, not only find its place but *make* its place by seeing a social need as yet unrealized by others.

#### FURTHER DEVELOPMENT OF THE ORGANIC CONCEPT

In the use of the organic concept as applied to society, we have noted development along several lines. First, from the vagueness of the concept of society as used by Comte and Schäffle, through the nationalism of most of the German school, to the variable definiteness of the concept as used by Durkheim; i. e., with him any social group or unity becomes a society under certain conditions.<sup>1</sup> It is well to note in passing that others consider society, not as an object or unity, but rather as a process.<sup>2</sup>

A second line of development is in the conception of the kind or grade of organism to which society is analogous. Spencer held that society could be compared only to the lowest forms of biological organisms but today, with increasing emphasis on the psychical, the tendency is to compare it to the most highly-developed personality, endowed with self-consciousness and intelligent, purposeful volition.<sup>3</sup> With this has come, too, for the most part, emphasis on centralized government, the analogue of the ever increasing power of the central nervous system in biological organisms.

A third line has been in a change of emphasis from analysis of the structure of the organism as with Spencer, through that of function as with Schäffle, to an analysis of social consciousness as with Durkheim, and of the laws of social and socio-psychical development as with the authors we are about to consider.

Before passing to a discussion of this last phase, which carries us beyond the organicists, we must consider briefly some further developments of the concept of social consciousness.

<sup>1</sup> Cf. Boodin, *American Journal of Sociology*, xix, p. 37.

<sup>2</sup> For an illuminating discussion of the theories of society as held by German sociologists, cf. Jacobs, *German Sociology*, pp. 31 f. Ellwood, *Sociology in its Psychological Aspects*, pp. 382-395. Boodin, *op. cit.*, p. 21.

<sup>3</sup> Boodin, *op. cit.*, pp. 37 f. Deploige, *op. cit.*, p. 161.

In the writings of Durkheim is brought out clearly the concept of social consciousness with some kind of objective reality, — whether phenomenal or ontological is not discussed. Granted that there is some kind of real objective unity that is applicable to human beings in association whether phenomenal or ontological, static or dynamic, whether predominately mediated by thought, feeling, will, or a combination of these, we have next to enquire if there is anything in this unity corresponding to the self-consciousness characteristic of highly-developed man. This seems to be the bone of contention among social psychologists today, together with that other related and perplexing problem as to the relation between the individual mind and the social mind. Discussion of the development of thought along this line would carry us through the whole range of recent socio-psychical literature, but we may call attention in passing to James' doctrine of selves and self-consciousness as of special importance. According to him we have a "hierarchy of the *mes*." "A tolerably unanimous opinion," he says, "ranges the different selves of which a man may be 'seized and possessed,' and the consequent different orders of his self-regard in a *hierarchical* scale, with the bodily me at the bottom, the spiritual me at the top, and the extra-corporeal material selves and the various social selves between." <sup>1</sup>

This concept, making the approach to the discussion of social self-consciousness from the point of view of biology and individual psychology as do Schäffle, Fouillée, Ratzenhofer, McDougall, Giddings and most of the other sociologists and social psychologists, is repudiated by Dewey, Cooley,<sup>2</sup> Boodin<sup>3</sup> and a few others who make the approach from the point of view of spiritualistic monism and by Gumpłowicz from the point of view of positivistic-social-pluralism, all of whom arrive at what might legitimately be termed *social realism*. According to them individual consciousness and self-consciousness are differentiations of original group consciousness. A clarifying discussion of the whole subject is the

<sup>1</sup> *Briefer Course*, p. 190. Cf. McDougall, *Social Psychology*, chs. VII and VIII.

<sup>2</sup> *Social Organization*, ch. I; *Human Nature and the Social Order*, ch. I.

<sup>3</sup> *Op. cit.*



analysis of social mind by M. M. Davis.<sup>1</sup> His outline is as follows:—

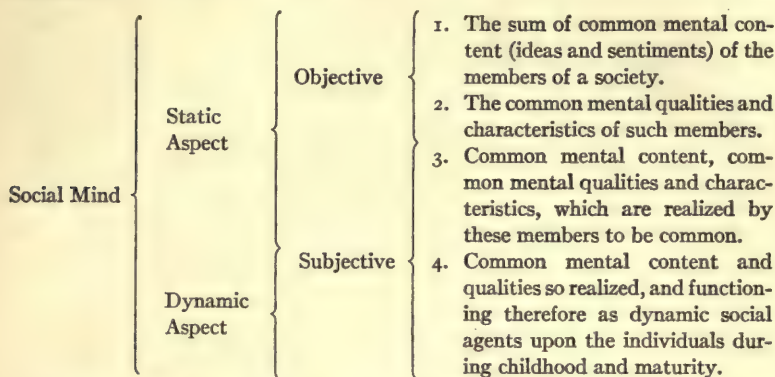

Davis seems to feel that by social mind we should mean 3 and 4, both subjective aspects, the former static whereas the latter is dynamic.

In its essence and practical important bearings, the social mind is to be viewed subjectively. Common beliefs, sentiments, and determinations, exist only in individual minds. They influence individual thoughts and acts. They are essentially independent of any individual in the sense that they would continue to be influential if any one man containing them was removed from society. But we call these common beliefs, etc., a social mind, not merely because they are held in common but because of something more. They become social and make of society a psychic unity, because of the way in which individuals regard them. They are realized to be common. Beliefs or tendencies, once thought of as common, acquire a new relation to the individual because of this realization. They become dynamic agents, influencing action directly and powerfully.

This is Ellwood's position: "Society as a group of individuals carrying on a common life process, thinks, feels and wills only through its individual members. Society . . . must be thought of as a complex unity made up of many individual psychic units that are in interaction, continually affecting and modifying each other, so that the only unity which we have in society is a unity of process."<sup>2</sup>

Worms certainly made a good point when he held that social consciousness was like the personal ego because the essential characteristic of being is doing. "Was wirkt, wie das sociale

<sup>1</sup> *Columbia University Studies*, xxxiii, p. 68.

<sup>2</sup> *Op. cit.*, p. 330.

Bewusstsein, muss ein Wesen sein und da es Bewusstsein ist, muss es sich denken." <sup>1</sup> Yet this does not prove ontological reality. Men can work together for a common end without having a consciousness of corporate or socio-psychic continuity as is true of normal human beings. The "constellation" or "fusion" which is the essence of the social reality,<sup>2</sup> and the background of social self-consciousness, if there be such, is temporary. No one, so far as I am aware, has shown that there is anywhere in the social order a consciousness of socio-personal continuity, — of identity persisting in change, — such as characterizes the personal ego.

We conclude as follows: —

1. There is one cosmic process, differentiated in the social order into individuals and into social groupings.

2. The individuals and groups become organized on the basis of consciousness of kind and consciousness of supplementary difference, having as their basis individual and group interests.

3. There is mental interaction, inter-stimulation and response, resulting in a phenomenon well expressed by the term fusion.

4. The process of fusion or creative synthesis is, on the one hand, a process of progressive co-adaptation among the members and, on the other, a process of progressive adaptation of the particular social unit to its physical and spiritual environment.

5. There is more or less agreement in ideals, purposes, etc.

6. At times there is unanimity in feeling due to similar response to a common stimulus.

7. There is a permanent yet ever-changing core in every social organization or *organism* to which the spiritual part of every individual member is to a greater or less degree assimilated.

8. This core of social personality, if one cares to use the term, exercises constraint on each individual, and forms the background of the group, but is constantly modified by the total changing situation.

9. Each individual is at times conscious of his organic relation to the various groups to which he belongs; i. e., his self-conscious-

<sup>1</sup> Barth, *op. cit.*, p. 162.

<sup>2</sup> Cf. Boodin, *op. cit.*, pp. 20, 38.

ness and self-regarding sentiment extend to include the group and he feels or believes that others are going through a similar experience, but there is no group consciousness of this persisting core of social personality corresponding to that of the individual ego.

10. This gives ground for the belief that the individual personality has some kind or degree of ontological reality not possessed by any group.

## CHAPTER VIII

### THE ANTHROPOLOGICAL SOCIOLOGISTS

TURNING from those who have emphasized the importance of physical factors in social evolution, as Buckle, Ratzel and Ripley, from those whose argument is based chiefly on a deductive application of the neo-Darwinian formula of biological evolution, as Nietzsche, Kidd, Galton, Pearson and Lapouge, from those, too, whose interest has been largely philosophical or socio-psychical and who have discussed some theoretical principles of fundamental importance to our subject as the organicists, we turn now to some representative writers who have emphasized the necessity of studying the process of social evolution inductively to find out the laws and forces of social development. These writers differ greatly among themselves as they are interested primarily in social origins as the anthropologists, or in the whole process as the historical school, or again in the forces now at work as the economists and social psychologists. They differ also as they try to find some one all-embracing law or principle corresponding to the law of gravitation or posit a number of distinct laws and forces. A third line of cleavage is as to whether the individual *socius* is made the point of departure and society explained as some kind of combination of *socii*, or whether the group is taken as the unit. A fourth distinction might be made according as they recognize a mutual hatred and struggle as the chief characteristic of primitive or "natural" man or sympathy and mutual aid; and here again a strictly logical classification of writers is impossible for they overlap at so many points.

The anthropological and historical schools have met with especially great difficulties, as we noted in the discussion of Spencer, because of the uncertainty connected with social origins.<sup>1</sup> With the discovery of relics of human ingenuity in geological

<sup>1</sup> Cf. Boas, *Mind of Primitive Man*, pp. 99, 182.

strata and also of portions of the human skeleton some basis has been found for scientific generalizations.<sup>1</sup>

Besides relics of bygone ages and peoples, anthropologists have endeavored to get light on prehistoric conditions from the following sources: (1) operations of modern savages; (2) the publications of historians and travelers who were acquainted with savage tribes long ago; (3) the languages of cultured and uncultured races; (4) the makeshifts and contrivances of children and of the folk who never receive letters-patent upon their devices.<sup>2</sup> But the presupposition in every case except that of relics is that savages of these later centuries are like those of earliest time. This assumption is based on some logical principle of classification as with Spencer and De Greef, on the theory of recapitulation<sup>3</sup> as with Liliensfeld and many pedagogical writers, or on the theory that mind is essentially the same in its operations and manifestations everywhere and in all ages. This last is accepted so generally today that it must be regarded as of scientific worth though even here the principle must be used with caution.<sup>4</sup> Anthropologists are generally agreed today, also, that social development has not been linear, but by a process, either similar to that termed by Ward "sympodial," or irregular, determined by environmental conditions.

At the other extreme of those who emphasize social origins and genetic development is T. N. Carver, who holds that "all past development . . . must be accounted for on the ground of forces and factors now at work, and which can be observed at first hand by the student"; and that "it is in this study of first-hand materials, in the observation of social activities about us, that we must get our clue to the relation of cause and effect in social and political affairs."<sup>5</sup>

<sup>1</sup> Keith, *Ancient Times*; Keane, *Ethnology*, ch. IV.

<sup>2</sup> Mason, *Origin of Invention*, pp. 28, 29. Cf. Boas, *op. cit.*, p. 182.

<sup>3</sup> For criticism of this theory, see Kellogg, *Darwinism To-day*, p. 21; Mason, *op. cit.*, p. 45; Thorndike, *Educational Psychology*, i, pp. 248 ff.

<sup>4</sup> Cf. Boas, *op. cit.*, pp. 184-195; Ross, *Foundations of Sociology*, p. 61; Tylor, *Early History of Man*, pp. 5, 190. The chief difficulty is to find primitive savages, practically all, even when visited and "written up" hundreds of years ago, having come in contact with higher or lower cultures.

<sup>5</sup> *Sociology and Social Progress*, p. 5.

It is difficult to select representatives from the large and growing number of anthropologists who have contributed to our subject.<sup>1</sup> Spencer devoted much of his sociology to a discussion of primitive man but was led astray by his principle of classification and by reports which have since been corrected. More recent investigations have tended to discredit his teaching concerning the intellectual and emotional equipment and beliefs of primitive man.<sup>2</sup> We will review in this chapter the main theses of Sumner and Boas, the former approaching the subject from the neo-Darwinian point of view, the latter emphasizing the influence of environment and opportunity. We will also touch upon the conclusions of some others, adding suggestions as to the value of the concept of adaptation in anthropological interpretations.

WILLIAM G. SUMNER (1840-1910)

*Folkways*

Although Sumner was primarily a sociologist, we have in *Folkways* a mine of classified information concerning social origins which is invaluable if one would appreciate the place of adaptation in the development of folkways and mores among primitive groups.<sup>3</sup>

Sumner's general attitude of *laissez faire* is brought out in his earlier book *What Social Classes Owe to Each Other*. In this later work we have the neo-Darwinian formula applied to the development of folkways and social institutions. The main thesis is that "the mores are always right"; but this is not to be taken absolutely. The meaning is that the mores furnish the standard of right for each group at every particular period.<sup>4</sup> Although many rites and ceremonies grew up as a response to what he terms the "aleatory element" or luck,<sup>5</sup> and many were positively injurious,<sup>6</sup> yet on the whole, and in the long run, only those groups survived who built up their folkways and mores on the principle of utility.

<sup>1</sup> See ch. VI, review of W. Z. Ripley.

<sup>2</sup> Thomas, *Source Book*, pp. 143 ff.; Angell, *Chapters from Modern Psychology*, pp. 247 f.; Keith, *op. cit.*, p. 26.

<sup>3</sup> For distinction, see *Folkways*, ch. I.

<sup>5</sup> *Ibid.*, p. 6.

<sup>4</sup> *Ibid.*, pp. 28, 58, 521 f., 532.

<sup>6</sup> *Ibid.*, pp. 26 f.

Granting that all origins are lost in mystery,<sup>1</sup> he holds that by study of primitive life as observed and recorded during the past few centuries, and of the forces now at work, we are able to reach valid conclusions as to the development of mores. How these arise, largely by an unconscious process of trial and error, and how they are related to the folkways is well brought out in a recapitulation he gives of his preliminary analysis: —

Men in groups are under life conditions; they have needs which are similar under the state of the life conditions; the relations of the needs to the conditions are interests under the heads of hunger, love, vanity and fear; efforts of numbers at the same time to satisfy interests produce mass phenomena which are folkways by virtue of uniformity, repetition, and wide concurrence. The folkways are attended by pleasure or pain according as they are well fitted for the purpose. Pain forces reflection and observation of some relation between acts and welfare. At this point the prevailing world philosophy (beginning with goblinism) suggests explanations and inferences, which become entangled with judgments of expediency. However, the folkways take on a philosophy of right living and a life policy for welfare. Then they become mores, and they may be developed by inferences from the philosophy or the rules in the endeavor to satisfy needs without pain. Hence they undergo improvement and are made consistent with each other.<sup>2</sup>

Sumner makes the group the sociological unit and evaluates individuals and classes according to their production of social utilities, holding that societal value depends on a harmonious combination of physical, economic, moral and intellectual elements and is measured roughly by income from work contributed to the industrial organization, whether by a member of the "masses" or by a genius.<sup>3</sup>

A race or group is classified by means of the normal frequency curve,<sup>4</sup> but the masses which determine the classification along certain lines are never the cause of progress nor the builders of institutions but these results come "by the selection of the leading men and classes who get control of the collective power of the society and direct it to the activities which will (as they think) serve the interests which they regard as most important."<sup>5</sup>

The mores make the right, not only because there is no other standard for the group, but because they are backed by force, and "nothing but might has ever made right."<sup>6</sup>

<sup>1</sup> *Folkways*, p. 7.

<sup>2</sup> *Ibid.*, p. 41.

<sup>3</sup> *Ibid.*, p. 49.

<sup>2</sup> *Ibid.*, p. 34.

<sup>4</sup> *Ibid.*, p. 43.

<sup>5</sup> *Ibid.*, pp. 64, 65.

Sumner carries his discussion on to the development of the "ethos" or group character,<sup>1</sup> — a concept corresponding to that of "soul" as used by Le Bon. The greater part of the book is given to illustrations of the above principles concerning the development of such mores as slavery, abortion, infanticide, killing of the old, cannibalism, sex relations, and those connected with social codes, kinship, blood revenge, primitive justice, social harlotry, etc.

Although principal attention is given to the spontaneous development of folkways and mores, Sumner makes place for criticism and improvement. As these can come only from the élite, he advocates critical ability as an important element in education. "It is only by high mental discipline," he says, "that we can be trained to rise above that atmosphere [of the mores] and form rational judgments on current cases. This mental independence and ethical power are the highest products of education."<sup>2</sup> Further on he says, "In the organization of modern society the schools are the institutional apparatus by which the inheritance of experience and knowledge, — the whole mental outfit of the race, — is transmitted to the young. . . . The transmission ought to be faithful, but not without criticism. The reaction of free judgment and taste will keep the mores fresh and active, and the schools are undoubtedly the place where they should be renewed through intelligent study of their operation in the past."<sup>3</sup> Social evolution is thus, with Sumner, almost entirely a passive process, individuals and groups working out their salvation in proportion to a fortunate selection of ways of acting. Rational choice is very rare, even among the most highly-civilized races.

Sumner is open to criticism chiefly at two points, first, in his use of the neo-Darwinian formula without proving that it works the same in social as in biological evolution, and second, in his failure to bring out clearly the difference between the right and good as seen by the people and the right and good as seen by the élite and demonstrated as such by consequences.<sup>4</sup> From this point of view we might substitute for Sumner's, "The mores are

<sup>1</sup> *Folkways*, pp. 70 f.

<sup>2</sup> *Ibid.*, p. 532.

<sup>3</sup> *Ibid.*, p. 635.

<sup>4</sup> Cf. Hobhouse, *Morals in Evolution*, pp. 26 f.



always right," the other extreme brought out somewhere by Ross, "The mores are never right"; that is, mores are of necessity adaptations to past conditions, and as life is a process they can never keep up with that process.<sup>1</sup> Sumner's book is, however, a valuable contribution to our discussion as his multitude of citations and illustrations show how important is this principle of adaptation in the formulation of folkways among primitive people.

FRANZ BOAS (1858- )

*Opportunity and Race Progress*

At the opposite pole from Sumner and all Darwinian anthropologists, is Franz Boas who minimizes differences in native ability among individuals and races, and emphasizes the time element in social evolution which, working through environment and historical events, has determined the differential in achievement of extant races.<sup>2</sup> According to him, the present superiority of European races may be accounted for along the following lines of reasoning: (1) Social and economic causes working through a more favorable habitat gave the European races the advantage in social progress; (2) Consciousness of kind operates today to prevent the rise of the backward as it did not a few thousand years ago; (3) Social progress in Europe has brought a higher form of social organization, making possible greater achievement; (4) The devastating influences of diseases resulting from the contact of primitive with cultural groups is a hindrance to the progress of the former today as it was not to the ancestors of the latter; (5) Industrial development among the cultural groups gives them ever increasing advantages over the non-cultural, and the expansion of the former holds back and drives back the latter. Boas concludes that "achievement alone does not justify us in assuming greater mental ability for the white race than for others, unless we can sustain our claim by other proof."<sup>3</sup>

<sup>1</sup> Cf. Sumner, *op. cit.*, p. 634: "The folkways need constant rejuvenation and refreshment if they are to be well fitted to present cases."

<sup>2</sup> *Mind of Primitive Man*, p. 9.

<sup>3</sup> *Ibid.*, p. 17.

Our author questions the alleged greater similarity of primitive than of modern types of man to the anthropoid apes, showing that this is true only of certain selected features, while in some other respects modern types show greater similarity than primitive types to their sub-human forbears.<sup>1</sup> Granting that on the whole the brain of modern man is larger and heavier than that of primitive man, he refuses to grant to this fact a proof of greater mental capacity.<sup>2</sup>

Boas discusses at length the influence of environment upon human types and shows how climate, food and labor have registered their effect.<sup>3</sup> The permanency of somatic characters, so emphasized by Gumpłowicz and Deniker, is refuted by our author, not only on the authority of Wiedersheim,<sup>4</sup> but by reason of modern measurements by Bowditch, Peckham, Ammon, and Ripley<sup>5</sup> as well as by his own measurements of immigrants to America and their descendants. In this study the traits selected for examination were head-measurements, stature, weight and hair-color, and the ethnic groups chosen were the South Italians, representing the Mediterranean type of Europe, the Central European type, the Northwest European type, and the East European Hebrews. "The results of our inquiry," he says, "have led to the unexpected result that the American-born descendants of these types differ from their parents; and that these differences develop in early childhood, and persist throughout life."<sup>6</sup>

Our author is unable to explain these somatic changes from the type, but holds that they prove that human types are plastic

<sup>1</sup> "The European shares lower characteristics with the Australian, both retaining in the strongest degree the hairiness of the animal ancestor, while the specifically human development of the red lip is developed most markedly in the negro. The proportions of the limbs of the negro are also more markedly distinct from the corresponding proportions in the higher apes than are those of the European," *Mind of Primitive Man*, p. 22.

<sup>2</sup> *Ibid.*, pp. 24-28.

<sup>3</sup> *Ibid.*, pp. 23, 27, 40, 116. "I am inclined to believe that the influence of environment is of such a character that, although the same race may assume a different type when removed from one environment to another, it will revert to its old type when replaced in its old environment," *ibid.*, p. 76.

<sup>4</sup> *Ibid.*, p. 41.

<sup>5</sup> *Ibid.*, pp. 45 f.

<sup>6</sup> *Ibid.*, p. 54.

within limits.<sup>1</sup> He shows further that the changes in the human frame as a result of civilization are analogous to those in animals as a result of domestication,<sup>2</sup> there being this difference, however, that whereas change of environment (especially with change of nutrition and mode of life), conscious selection, and crossing, have all been potent factors in the development of different types of domesticated animals, change of environment and crossing have been most strongly active in the development of the races of man.<sup>3</sup>

Boas explains the occurrence of distinct local types in primitive races<sup>4</sup> in contrast to the variability to be found among civilized<sup>5</sup> as due to differences in environment, to isolation and in-breeding. Our author shows how chaotic our information is as to the characteristics of primitive races,<sup>6</sup> and questions the conclusion of Spencer concerning the great native differences in primitive and civilized man as regards fickleness, strength of passion, lack of control, improvidence, inability to concentrate attention, and lack of originality.<sup>7</sup> He believes that "the differences between civilized man and primitive man are in many cases more apparent than real; that the social conditions, on account of their peculiar characteristics, easily convey the impression that the mind of primitive man acts in a way quite different from ours, while in reality the fundamental traits of the mind are the same."<sup>8</sup> Our author admits, however, differences in mental traits among individuals and races, and believes that the efforts of such investigators as Galton will be able yet to analyze and classify them with some degree of precision.<sup>9</sup> He concludes that "while it is likely that changes of the mental character go hand in hand with the undoubted changes in the human anatomy, . . . we cannot prove that any progressive changes of the human organism have taken place; and particularly no advance in the size or complexity of the structure of the central nervous system, caused by the cumulative effects of civilization"; moreover, that "the difficulty of proving a

<sup>1</sup> *Mind of Primitive Man*, p. 64.

<sup>2</sup> *Ibid.*, pp. 66 f., 75.

<sup>3</sup> *Ibid.*, pp. 68-70.

<sup>4</sup> *Ibid.*, pp. 75 f.

<sup>5</sup> *Ibid.*, p. 93.

<sup>6</sup> *Ibid.*, pp. 101 f.

<sup>7</sup> *Ibid.*, pp. 106 f.

<sup>8</sup> *Ibid.*, p. 114.

<sup>9</sup> *Ibid.*, p. 116.

progress of faculty is even greater.”<sup>1</sup> He believes that a large proportion of individuals among primitive races are capable of reaching the level of civilization represented by the bulk of our own people.<sup>2</sup>

Boas holds that language does not furnish the much-looked-for means of discovering differences in the mental status of different races, but on the contrary, that similar cultural traits are found in most widely-separated groups and languages.<sup>3</sup>

Our author criticizes strongly the use of the evolutionary formula as often applied to social progress concluding that “the assumption of a uniform development of culture among all the different races of man and among all tribal units is true in a limited sense only,” — that increasing complexity, for example, does not apply to linguistic development or to that of music and art.<sup>4</sup>

Applying his conclusions to race problems in America, he says that “the danger to the vigor of the American nation due to an influx of alien European types, is imaginative, not real.”<sup>5</sup> His attitude on the negro question is very similar. Rejecting the theory of racial inferiority, he does not believe there is anything to be feared from race mixture.<sup>6</sup>

Boas has contributed to our subject chiefly by way of criticism of the dogmatism of many social evolutionists, and “selectionists,” by the scientific, inductive spirit of his work and by the prominence given to the factor of environment in variation and progress.

His contribution is almost wholly along the line of passive physical adaptation. There is a seeming lack of the sociological point of view, however, especially in his discussion of race problems in the United States. The problem of immigration and the amalgamation of diverse races is as much social as biological, and the social results that come from the union of representatives of diverse ethnic groups are not usually satisfactory.<sup>7</sup> Moreover,

<sup>1</sup> *Mind of Primitive Man*, pp. 118, 119.

<sup>4</sup> *Ibid.*, p. 194.

<sup>2</sup> *Ibid.*, p. 123.

<sup>5</sup> *Ibid.*, p. 262.

<sup>3</sup> *Ibid.*, ch. V, esp. pp. 133, 154.

<sup>6</sup> *Ibid.*, p. 277.

<sup>7</sup> Boas touches this question (p. 277), and says: “When the bulky literature of this subject is carefully sifted, little remains that will endure serious criticism; and

he grants enough of the claims of the biological sociologists to warrant belief in a sufficient differential in individual and racial types in the line of quantity of intellectual power and quality of predispositions, to make a considerable difference in the relative strength of competing groups.

Westermarck and Hobhouse<sup>1</sup> occupy a position midway between Sumner and Boas, both being representatives of what might be called "progressive orthodoxy." Westermarck is most widely known for his defence of monogamy as the primitive form of the family against Morgan, Bachofen and McLennan, but it should also be recognized that he stands for the supremacy of motive in ethical evaluations as against the theory of the utilitarians.<sup>2</sup>

Hobhouse has taken pains to criticize the neo-Darwinian sociologists and point out how far short this formula comes of expressing the truth of social evolution, yet he makes large use of this principle in his *Morals in Evolution*, but even greater use of the principle of adaptation,<sup>3</sup> and shows how in ethical development the process has been from the unconscious behavior of individuals and groups in response to needs and in accordance with environmental conditions, physical and social, to the reflective choice which characterizes the highest types of morality.<sup>4</sup> He holds, contrary to Buckle, that there has been real ethical progress but not, as most neo-Darwinians affirm, in the development of new instincts and impulses in man or in the disappearance of instincts that are old and bad, but rather in the rationalization of the moral code which, as society advances, becomes more clearly thought out and more consistently applied.<sup>5</sup> Nor has this ethical progress been in a straight line or correlated with progress along other lines as Comte assumed. "On the contrary," he says, "the very conditions of the development of society have in some cases been hostile to moral development for the time being. An advance in the arts of life may well

I do not believe that I claim too much when I say that the whole work on this subject remains to be done." Cf. Le Bon, *op. cit.*, pp. 52 f.

<sup>1</sup> E. Westermarck (1862-), L. T. Hobhouse (1864-).

<sup>2</sup> *Origin and Development of Moral Ideas*, i, ch. XI.

<sup>3</sup> *Morals in Evolution*, Introduction.

<sup>4</sup> *Ibid.*, pp. 20 f.

<sup>5</sup> *Ibid.*, p. 34.

work retrogression in the ethical sphere.”<sup>1</sup> He shows how the principle of adaptation has been at work but not rigidly, for “Society’s shoulders are broad, and they can bear many a burden imposed by human perversity without breaking down. Many injurious customs may arise and flourish as long as they do not touch the social life in a vital spot.”<sup>2</sup>

Hobhouse deserves credit for distinguishing between logical classification and genetic order and holds that as ethical and social evolution have not been linear we cannot be sure of the identity between the order of classification and that of temporal development.

The position of Thomas<sup>3</sup> approaches more nearly to that of Boas with emphasis on environment.<sup>4</sup> He is deserving of notice because of his grouping together of three factors in progress, *control, attention and crisis*, — in his discussion of these making large use of the concept of adaptation, — also for the importance he places on the “great man.” Control is the end, attention the means, and crisis furnishes the occasion for the calling forth of attention, while the “great man” is the one who first responds effectively to a social crisis, directs the attention of others and leads the way to social telesis.<sup>5</sup>

On the whole Sumner and Boas have contributed primarily to the development of the concept of passive spiritual adaptation whereas Westermarck, Hobhouse and Thomas have contributed also to that of active spiritual adaptation.

This principle of adaptation has been of service to anthropologists in their endeavors to solve such problems as the connection between man and the anthropoid apes both physically and psychically,<sup>6</sup> the original habitat of man,<sup>7</sup> his earliest mechanical

<sup>1</sup> *Morals in Evolution*, p. 35.

<sup>2</sup> *Ibid.*, p. 18.

<sup>3</sup> W. I. Thomas (1863-).

<sup>4</sup> Shown by his choice of selections in his *Source Book*, as well as by his Introduction and the comments at the close of each chapter.

<sup>5</sup> *Source Book for Social Origins*, pp. 14 f.

<sup>6</sup> Cf. *supra*, conclusions to ch. IV.

<sup>7</sup> Hoernes, *Primitive Man*, p. 6.

inventions<sup>1</sup> and social institutions, racial differences<sup>2</sup> and early migrations.<sup>3</sup> For example the historical investigations of Sir Henry Maine left the question of the pre-historic family untouched save by inference. The anthropological researches of Bachofen, McLennan, Morgan and Lubbock have come to be considered as based on insufficient and misleading evidence, and the most potent weapon of criticism of their conclusions, as used by Spencer, Howard, Westermarck and others, is just this theory of adaptation. Granted that primitive people were ignorant of the relation between copulation and child-birth, we may still argue for a more or less permanent relation between the sexes from monogamic mating among birds and higher mammals, from jealousy, and from economic need, also from the more recent studies of sex mores among extant types of primitive culture. Moreover, whatever the first form, promiscuity could not prevail because of its dis-utility owing to its connection with venereal diseases and low fecundity, and because of its effect on childhood. Thus the earliest form and changes in it were in accordance with this principle of adaptation.

<sup>1</sup> Mason, *Origin of Inventions*, ch. I.

<sup>2</sup> Marett, *Anthropology*, pp. 93 f.; Keane, *Ethnology*, ch. X; also *Man Past and Present*, p. 13; Boas, *op. cit.*, ch. II.

<sup>3</sup> Chapin, *Social Evolution*, pp. 141 f.

## CHAPTER IX

### THE HISTORICAL SOCIOLOGISTS

LUDWIG GUMFLOWICZ (1838-1910)

#### *Progress by Inter-Group Conflict*

GUMFLOWICZ takes as his point of departure Comte's positivism and Spencer's theory of deterministic evolution but criticizes the former for giving any place whatever to policies of social amelioration, claiming that all such are absurd in a deterministic system, and criticizes the latter for taking the individual as his unit instead of the primitive horde, also for his failure to distinguish the different realms in the cosmic process governed by entirely different kinds of laws.<sup>1</sup> In this he seems strangely inconsistent for while criticizing monism and its attempt to find a universal law for events in the whole domain of nature, holding that all such attempts fail to distinguish between universal and social laws,<sup>2</sup> yet a little further on in his discussion he says, "Modern natural science has successfully demonstrated that even 'human mind' is subject to physical laws; that the phenomena of the individual mind are emanations from matter," and then proceeds to lay down ten laws that are universal.<sup>3</sup> He is a strict determinist and finds the goal of life-philosophy in resignation to the inevitable.<sup>4</sup> This position together with his assumption of the multiple origin of humanity might warrant his being called a pluralistic-positivist.

Gumpłowicz criticizes the organicists with special vigor but gives Spencer credit for a discriminating use of the concept.<sup>5</sup>

All cosmic phenomena are classified into physical, mental and social,<sup>6</sup> all controlled by the operation of the following

<sup>1</sup> *Grundriss der Sociologie* (1885), pp. 4 f. (Moore's Translation, pp. 24 f.).

<sup>2</sup> *Ibid.*, p. 14 (Moore, p. 32).

<sup>3</sup> *Ibid.*, pp. 62 f. (Moore, pp. 74 f.).

<sup>4</sup> *Ibid.*, pp. 4, 228.

<sup>5</sup> *Ibid.*, pp. 11 f.

<sup>6</sup> *Ibid.*, pp. 55 f.



cosmic laws: (a) causation, (b) development, (c) regularity of development, (d) periodicity, (e) complexity, (f) reciprocal actions of foreign ("heterogen") elements, (g) adaptation to an obvious end, (h) identity of forces, (i) similarity of events, (j) parallelism.

The law of reciprocal action of foreign or "heterogen" elements is especially important in Gumpłowicz's theory and he finds the social analogue of the original cosmic, atomic elements in the innumerable small, diverse groups or hordes with which history began.<sup>1</sup> He bases his conclusion concerning the multiple origin of races (1) on the findings of anthropologists concerning the physiological differences of individuals in every race and tribe, holding that as these are strictly hereditary they signify different origins; <sup>2</sup> (2) on the fundamental and irreducible differences to be found between various languages <sup>3</sup> and (3) on the variety of primitive religions.<sup>4</sup>

The starting point of sociology, then, is these innumerable primitive hordes, each with its own language, morals, religion, etc., each with great similarity and equality between individual members,<sup>5</sup> each possessed of consciousness of kind and instinctive hatred of every other horde or group.<sup>6</sup> Increase of population and necessity of self-maintenance bring these groups into conflict resulting in the annihilation or subordination of the conquered. This act of enslavement introduces into the victorious group the element of inequality which is the starting point of social organization and which furnishes the basis of conceptions of right and justice.<sup>7</sup>

<sup>1</sup> *Grundriss*, p. 66 (Moore, pp. 78 f.).

<sup>2</sup> *Der Rassenkampf*, pp. 41 f.; *Grundriss*, pp. 81 f. Cf. also Fiske, *Excursions of an Evolutionist*, ch. V, who seems to agree with Gumpłowicz.

<sup>3</sup> *Der Rassenkampf*, pp. 56 f.

<sup>4</sup> *Ibid.*, pp. 137 f.

<sup>5</sup> *Grundriss*, p. 190; *der Rassenkampf*, p. 64.

<sup>6</sup> *Grundriss*, p. 195: "Es gibt kein Recht, das nicht der Ausdruck der Ungleichheit wäre weil all und jedes Recht die Vermittlung ist zwischen ungleichen socialen Elementen, die Ursprünglich, zwangsweise herbeigeführte Versöhnung widerstreitender Interessen, welche erst durch Uebung und Gewohnheit auch die Sanction der neuen Sitte erlangt," *ibid.*, p. 190.

<sup>7</sup> *Grundriss*, pp. 91 f., 135 f., 177 f., 189 f.

There are not now, he holds, and so far as we know there never have been any pure races, the so-called historical races being compounds formed by the amalgamation of separate ethnic groups and by cross-fertilization of cultures.

As all social development has resulted primarily from inter-group struggle, there has been no opportunity for selection as a result of struggle between individuals, hence no increase in the innate mental capacity of man but only in knowledge due to social heredity.<sup>1</sup>

In discussing the origin of social classes Gumplowicz uses biological analogies but his interpretation of biological evolution is far from satisfactory. He makes heredity and adaptation (*Erblichkeit und Anpassung*) the two opposing methods of explaining the origin of species, or again, autogenesis and evolution (*Autogenismus und Evolutionismus*).<sup>2</sup> By the first he seems to mean spontaneous variation and its hereditary transmission and by the latter physiological changes in the developing organism to adapt it to its environment and the transmission of these slight variations to the offspring. Two other terms are used, the latter of which seems entirely out of place in biology: originality and imitation (*Originalität und Imitation*).<sup>3</sup> Applying these laws to the formation of social classes he says:—

We have seen how some classes (the ruling, the peasant and the business classes) arose out of the union of heterogeneous ethnical elements; how their differences and individuality, original in each case, date from the time previous to the union and persist later when they form part of the state, because both the anthropological and moral peculiarities of each help to

<sup>1</sup> *Grundriss*, pp. 211 f., 222 f.

<sup>2</sup> *Ibid.*, p. 135. The use of these terms by Gumplowicz is unfortunate and does not correspond to modern terminology. In biology we have spontaneous or inborn and acquired variations. The first are inherited, the latter probably not. In social evolution, however, these acquired variations or habits are handed on by so-called social heredity, but both processes may be explained by the principle of adaptation, for those variations which handicap the individual, species, class or group too much, prevent survival in the struggle for existence.

<sup>3</sup> "Auf doppelte Art entstehen natürliche Gebilde, originär und sekundär. Es gibt in der Natur sozusagen zwei entgegengesetzte Strömungen, die sich immer und überall begegnen, und die wir Originalität und Imitation nennen könnten.

"Was nämlich die Natur originell, auf eine uns unbekannte 'schöpferische' Art geschaffen hat, das entsteht auch häufig unter dem Einfluss äusserer, uns wohl

maintain the separation and opposition of the classes and castes as they exist later in the state. But we have also noticed that there were other classes (the priests, large industries in opposition to small, scholars, jurists, officials, etc.) which have arisen by a process of differentiation, and only after this process has been completed and the classes clearly marked off, do they guard their peculiar interests in a way analogous to that of original classes.<sup>1</sup>

Group self-interest, whether of the original, natural groups and their compounds or of the interest groups formed later by the two-fold process described above, is the bond of unity, the source of conflict and the mainspring of progress.<sup>2</sup>

The social forces uniting groups and impelling to progress are classified as we find them in the table on the following page.<sup>3</sup>

begrifflicher und zu Tage liegender Umstände; diese letztere Art des Entstehens nennt die Schule Darwin's evolutionistisch.

“Autogenismus und Evolutionismus arbeiten sich nun überall in die Hände. Das verwirrt unsere Sinne. Wir streiten bei jedem organischen Gebilde; ist es autogenetisch oder evolutionistisch ?

“Nun kann aber ein und dasselbe Ding, ein und derselbe Typus (in vielen Fällen ist es nachgewiesen) auf eine oder die andere Weise entstehen, denn im Grunde ist es doch dieselbe natürliche Weise, so wie ein Maler ein Bild originell schaffen kann, dasselbe aber dann auch reproduzieren, kopieren kann.

“. . . Die doppelte Art der Entstehung ist übrigens leicht erklärlich. Wenn die geographische Lage und Beschaffenheit der Umwelt noch heutzutage im stande ist, auf die Modifikation eines organischen Typus bestimmend einzuwirken: wie viel mehr müsste dieses Agens auf die ursprüngliche Entstehung von Varietäten einwirken! Es waren sozusagen genetische Unterschiede, welche dieser Faktor einst erzeugte: er wirkt noch heute fort in geschwächtem Masse aber jene ursprüngliche genetische Wirkung erweist sich überall als dauerhafter und stabiler. Freilich erhält dadurch auch jene Argumentation den Schein von Berechtigung, welche sich an diese sekundäre Wirkung klammert und indem sie die kurze Zeit der Wirksamkeit dieser sekundären Faktoren ins Unendliche multipliziert, dadurch jede Annahme einer originären Entstehungsart als überflüssig erscheinen lässt. Aber diese Operation ist nur arithmetisch richtig, sie hat nur einen logischen Wert, eine logischen Berechtigung, ohne jedoch die Annahme einer originären, autogenetischen Entstehungsart, für die eine Reihe anderer Momente sprechen, je widerlegen zu können.

“Ebenso nun wie auf dem Gebiete der organischen Natur, begegnen sich auch auf sozialem Gebiete primäre und sekundäre, autogenetische und evolutionistische Entstehungsarten überall.” — *Grundriss* (1905). Few verbal changes from the first edition, pp. 137, 138 (Moore, pp. 134, 135).

<sup>1</sup> *Grundriss*, p. 135. (Moore, pp. 134 f.)

<sup>2</sup> *Ibid.*, p. 138.

<sup>3</sup> *Ibid.*, p. 146; cf. Moore, p. 142.

Material	Common dwelling place (more or less removed)		Temporarily For Life
	Common Social Life		
Economic (Wirtschaftlich)	Consanguinity		Generation after Generation
	Relationship		
	Rank	{ Nobility Burghers Peasants Professional classes, etc.	
	Possessions	{ Rural Urban	
Moral	Occupations		
	{ Landowners Farm tenants Manufacturers and industrial workers Merchants Artisans, etc.		
Moral	Language		
	Religion		
	Science		
	Art		
	Accidental fate (emigrants, etc.)		

“The greater the number of these socializing forces that bind men together, the stronger is the social bond, the greater the social cohesion, and as a result the greater the power to withstand opposition, and especially as these operate over long periods of time.”<sup>1</sup>

Like Spencer, Schäffle and others, our author believes in a cycle of social development and decay due to the play of natural laws. “It is not difficult to show the causes of this cyclical motion in the natural, economic and social conditions of folk-life,” he says. “. . . Men’s wants and desires . . . cause them to raise themselves by groups and societies from a primitive condition to a condition of culture and civilization; and, having once attained it, so to conduct themselves that their fall necessarily follows through other groups and societies in a progressive state.”<sup>2</sup> The chief cause assigned for this decay is increase of

<sup>1</sup> *Grundriss*, p. 145. Cf. also *Soziologie und Politik*, pp. 84, 92-95.

<sup>2</sup> Moore, p. 205.

prosperity among the lower economic classes followed by decrease in population. This decay is inevitable, according to Gumpłowicz, for having ruled out all telic activity no group can forestall the operation of these "natural" laws. This particular illustration shows the inherent weakness of his whole system, for prosperity leads to limitation or decrease of population mostly through the operation of telic foresight. The first effect of industrial prosperity is rapid increase of population, as proven in the case of England, of Germany and of Japan. It is only when people have learned how to prevent conception and when, with emphasis on consumption rather than on production, they prefer other things to wholesome family life, that the results portrayed by our author take place. But if by telic foresight on the part of individuals population can be limited or even decreased, telic foresight on the part of a group might prevent this result and lead to social immortality.<sup>1</sup>

The individual as such has almost no place in Gumpłowicz's social theory. "The greatest error of individual psychology is the assumption that *man thinks*. . . . What thinks in man is not *he* but the social community of which he is a part. The fountain of his thought lies not in himself but in the social *milieu* in which he lives, in the social atmosphere which he breathes, and he cannot think otherwise than the influences of this milieu concentrated in his brain make necessary."<sup>2</sup> Again he says, "Not the individual but the group is egoistic. The heroes of history are only marionettes who carry out the will of the group."<sup>3</sup> This plasticity of the individual is shown by the ease with which he is assimilated into a new social environment,<sup>4</sup> and by the influence upon him of his economic and social status.<sup>5</sup> In his *Soziologie und Politik*, however, Gumpłowicz makes some place for the individual in his mechanical reaction to social pressure and so for his effect on the group. Speaking of the socio-psychical factors he says: "Every one of these factors is a product of the co-working of the individual and his group. Each of these factors, arising

<sup>1</sup> See *infra*, Conclusion.

<sup>2</sup> *Grundriss*, pp. 76, 165 f.

<sup>3</sup> *Der Rassenkampf*, p. 37.

<sup>4</sup> *Grundriss*, pp. 173 ff.

<sup>5</sup> *Ibid.*, p. 176.

out of a social movement, is a psychical deposit of the social life of the group and a result of the manifold adaptations of the individual to it.<sup>1</sup> Arbitrary freedom is an illusion.<sup>2</sup> Morality is nothing but the reflection in the individual mind of what has been considered useful for the group.<sup>3</sup> There is no right or justice apart from the might of the ruling class in the sovereign state, or as an abstract ideal formed by the oppressed classes as a means of securing liberation."<sup>4</sup>

Nowhere is the passive, purely mechanical character of social evolution better expressed than in these words: "Out of frictions and struggles, out of separations and unions of opposing elements, finally come forth as new adaptation products the higher socio-psychical phenomena, the higher cultural forms, the new civilizations, the new state and national unities . . . and this merely through social action and reaction, entirely independent of the initiative and will of individuals, contrary to their ideas and wishes and social striving."<sup>5</sup>

To Gumplowicz is to be given credit for a clean-cut demarcation and study of the sociological field, — the field consisting of the two-fold mechanical process by which all the modern races and social groups with their socio-psychical products have been evolved, on the one hand by inter-group conflict, and on the other by intra-group differentiation and struggle. His power of keen analysis is revealed in his discussion of the meaning of the term "society" which with him is always either a concrete natural, or interest group, or else a class term including all such groups.<sup>6</sup> He is worthy of commendation, also, for his consistency, on the whole, in carrying to a logical conclusion his fatalistic determinism, issuing in atheistic free-thought and stoical resignation to the inevitable. He is open to criticism along the following lines: —

1. He makes large use of biological analogies but as his biological interpretations are unsatisfactory his analogies fail to be

<sup>1</sup> *Soziologie und Politik*, p. 94. Cf. *Grundriss*, pp. 174 f.

<sup>2</sup> *Grundriss*, pp. 167, 215.

<sup>3</sup> *Ibid.*, pp. 179 f.

<sup>4</sup> *Ibid.*, pp. 114 f., 189 f., 237.

<sup>5</sup> *Soziologie und Politik*, p. 94.

<sup>6</sup> *Grundriss*, pp. 139 f.; *Soziologie und Politik*, pp. 49 f.

convincing. The factors of isolation and cross-breeding<sup>1</sup> are ignored while the Darwinian theory of natural selection is misinterpreted.

2. His assumptions concerning primitive groups and their mutual hatred are not sustained by facts. There is co-operation as well as strife, depending on conditions.

3. Though using the term progress in various places, such use is not warranted from his premises and from his assertion that there are no standards of value. Indeed there can be no values in a strictly deterministic system such as he has attempted to describe. He denies that there is such a thing as progress for humanity as a whole or for "civilization," though he grants that there may be for individual groups for a period of time. He grants that there may be progress, also, in scientific knowledge, although by this he seems to mean merely a heaping-up of information.<sup>2</sup>

4. He has failed to appreciate the dynamic of intelligence both in individual and social amelioration.

Finally, while granting the necessity of religion for complete adaptation,—for most people,—he seems to feel that the highest attitude toward the Great Unknown is that of the atheistic free-thinker.<sup>3</sup> Judged by the pragmatic test this cannot be true. His fatalistic philosophy of despair, — or of stoical resignation, — is not such as to inspire a group to heroic deeds or lead to that kind of social endeavor which might prevent the decay and destruction of the group that has attained wealth and culture. For this reason his social philosophy can never become the philosophy of the dominant group. It stands condemned as false before that judge which to him is the only judge, — the laws of life. Its normal outcome is the destruction of the group that accepts it and applies its precepts.<sup>4</sup>

Gumplowicz's greatest contribution to our subject is just this, — he has carried passive social adaptation to its logical conclu-

<sup>1</sup> His "cross-fertilization of cultures" is the social analogue, however.

<sup>2</sup> *Grundriss*, pp. 220 f.    <sup>3</sup> *Der Rassenkampf*, pp. 137 f.; Moore, pp. 108, 212 f.

<sup>4</sup> Gumplowicz comes under the condemnation pronounced upon the "anthropological moralist," by Professor Carver in his most recent book, *Essays in Social Justice*.

sion from the standpoint of fatalistic determinism. If he had said the last word the task of the social philosopher would be hard indeed because heartless. To rob people of the illusions of hope and delusions of religious belief without providing a better substitute may be in harmony with science, but surely not with pragmatic philosophy.

GUSTAV RATZENHOFER (1842-1904)

*Interests*

Social evolution with Ratzenhofer is to be explained as a process of progressive adaptation in conformity with law, yet it is not to be explained in the mechanical terms of attraction within and antagonism between "heterogen" groups resulting in annihilation, modification, and new combinations of elements, as with Gumpłowicz, but rather as a process by which the original power, the "Urkraft" or "Ursache" is able to come to ever increasing self-expression and self-realization under the limitations of organic structure and physical environment.<sup>1</sup>

The means by which this "Urkraft" works in and through organic nature is termed *Interest*. "Every form of phenomena from heavenly body to atom, and every organism is a part of the original force with an interest appropriate to its particular development. . . . These form the principle of creation."<sup>2</sup>

There are two kinds of consciousness, pure consciousness, i. e., the undifferentiated "Urkraft" as it exists in every creature, and the organic consciousness or the differentiated "Urkraft" that has struggled up through the evolutionary process to that self-consciousness which has its highest expression in adult, civilized man.<sup>3</sup> This endeavor on the part of the Urkraft to come to the largest and fullest experience of life is the cause of differences between species.<sup>4</sup>

The Urkraft and the inherent (anhaftende) or inborn (angeborene) interest are the two principles of creation, working to-

<sup>1</sup> *Die Sociologische Erkenntnis*, pp. 24, 28, 29, 39 f.

<sup>2</sup> *Ibid.*, p. 28.

<sup>3</sup> *Ibid.*, p. 26. Cf. p. 54.

<sup>4</sup> *Ibid.*, pp. 28, 29.



gether to "try out" all possible conditions of life that the result may be the largest possible experience of individual, self-conscious life. This inborn interest is the prime factor in attention, association, purpose and will. "One can apperceive nothing and think of nothing which does not conform to the interest inhering in it."<sup>1</sup>

The factors to be found in the lowest forms of organic life which make possible all further differentiation and development are as follows:—

1. The *Urkraft* endowed with the capacity of struggling to ever increasing development under conditions imposed by the environment.

2. *Interest* inborn in every creature.

3. The *power of assimilation* or the physiological impulse, also rooted in the interest but possessing different influence because it works no longer merely through the *Urkraft* within the creature but draws to it particles from the outside world.

4. *The influence of the phenomenal world.* The individual impelled by interest and struggling to come to completion, creates out of the conditions of life at hand the greatest possible advantage for the development of the species through variation and adaptation.

5. *Individuation*, or the process by which the creature working through the inborn interest builds up a unitary consciousness.

6. *Reproduction* as the result of the continuous working of the *Urkraft* in and through the individual.

7. *Heredity*, whereby the creature is able to bring forth only a like offspring on the basis of his inner capacity.<sup>2</sup>

*Selection and struggle for existence* are recognized as two further factors to be taken into consideration in the explanation of biological evolution.<sup>3</sup>

As a result of the struggle for development on the part of the *Urkraft* every "preformed" germ develops just in proportion as the conditions of life make possible,<sup>4</sup> even to the expression of purposeful acts of civilized man.<sup>5</sup>

<sup>1</sup> *Erkenntnis*, p. 34.

<sup>2</sup> *Ibid.*, pp. 40 f.

<sup>3</sup> *Ibid.*, pp. 302 f.; *Soziologie*, p. 23.

<sup>4</sup> *Ibid.*, pp. 38, 39.

<sup>5</sup> *Ibid.*, p. 46.

In his discussion of the inborn content of consciousness, Ratzehofer brings out a detailed analysis of *interest* which is one of his greatest contributions to sociology and especially to the development of the doctrine of adaptation.

As soon as the male germ cell has united with the ovum the following dynamic phenomena (Krafterscheinungen) are present:—<sup>1</sup>

1. The *Urkraft differentiated into life* to which we ascribe in general the power of bringing forth the whole developmental series, and through which the organized life is in relation to the cosmic forces. There is also present the impulse to try out all life-situations in order to produce the most complete creature possible. Thus this inherent life-power struggles against the barriers set by its environment, but in the sense of an inner impulse to ever larger life, in accordance with the universal law of adaptation. This struggle for the largest possible life brings the individual into conflict with other individuals and thus makes room for the Darwinian doctrine of selection.<sup>2</sup>

2. The *inborn interest* differentiated into several phenomenal forms by means of the life conditions under which the individual is developing as follows:—

(a) The *racial interest* which has the peculiar characteristic of maintaining, through reproduction, the species to which the creature belongs;<sup>3</sup> . . .

(b) The *physiological interest*, in general taken over from the mother as the new creature is a continuation of her physiological activity, . . . impels to a search for food and leads to the development of all other life interests; . . .

(c) In higher forms these original interests become differentiated, the physiological into an *individual interest* which has to do with the maintenance and development of individual life;<sup>4</sup> . . .

(d) The racial interest which because of the physiological connection between the individual and his ancestry easily expands to a *social interest*. The emotion of love is connected with this social interest but also with the sex impulse. Together they form the basis of the family.

These various interests often come into conflict; for example, the individual with the social, and the social with the racial. Under great temptation a man may force into the background his interest in his country, as the traitor; or a man may give this interest preëminence, self-interest and interest in family being thrust back, as the patriot in time of war. "In the lordship of the individual interest man sees himself not merely physiologically but really, as the center of the universe while in the lordship

<sup>1</sup> *Erkenntnis*, pp. 56 f.

<sup>2</sup> Cf. *ibid.*, p. 44.

<sup>3</sup> Cf. *Soziologie*, pp. 68 f.

<sup>4</sup> Ratzehofer accepts Spencer's law that individuation and fecundity are inversely proportional. Man is able to thwart the purposes of the *Urkraft* by suppressing the racial interest and living only for self.

of the social interest the outer world attains a reality for sensation which it does not possess psychologically. . . . The social interest widens our individuality so that we accept the phenomena of the outer world as integrating parts of the ego." <sup>1</sup>

"In general," he says, "the development of the social interest depends on the existence of such conditions as permit the physiological and individual interests to take the background; the higher interests come forth in the measure that the lower appear to be secured. The physiological interest satisfied gives room for the intellectual side of the individual interest, and the narrower family development must be secured in order that the interest in social relations may become lively." <sup>2</sup>

(e) The final mode of development of the inborn interest is the *transcendental*. Fear manifested in lower animals in the presence of unusual noises and terrifying phenomena of nature is a lower form of that which in man becomes religion. <sup>3</sup> . . . In man this usually takes the form of a sense of dependence upon that Original Power which awakens his consciousness. Moreover this sense of dependence is suppressed only as a result of man's attention being given entirely to the satisfaction of his physical needs, or even more frequently by the occupation of the mind in day-dreams as a result of a superabundance of goods. <sup>4</sup>

These inborn interests impel the organism to activities looking toward their satisfaction. The satisfiers lie in the environment, physical and social, and in the case of the transcendental, not only in the environment but within the individual himself; i. e., the Urkraft is the background of all existence, and the conscious apprehension of this is the result of a correct interpretation of all experience including a direct intuition of the relationship existing between the individual consciousness and the Urkraft of which it is a part. <sup>5</sup>

These interests become in a sense forces, i. e., an interest unsatisfied is a condition of mal-adaptation and gives rise to a feeling of unrest and of discomfort. <sup>6</sup> The very nature of an organism is to act in the line of satisfying its interests or needs. An organism that did not thus react to such impulses would not survive. <sup>7</sup>

<sup>1</sup> *Erkenntnis*, p. 62.

<sup>2</sup> *Ibid.*, p. 62.

<sup>3</sup> *Ibid.*, p. 63.

<sup>4</sup> *Ibid.*, p. 64.

<sup>5</sup> *Ibid.*, p. 65.

<sup>6</sup> *Ibid.*, p. 252.

<sup>7</sup> *Ibid.*, p. 106.

The inborn interests or needs as immediately related to organic activity seeking their satisfaction, are called motives (Triebe).

All the modal forms of the inborn interest come to expression in the individual first as a result of the directing activity of the Urkraft working in the life. The force derived from interest in the sense of the life-plan expresses itself as motive (Trieb). Just as interest comes to view as feeling-tone connected with sensation, so in real life it expresses itself as motive, so that interest and life united stand over against the outer world. Motives enter into consciousness and grip the circuit of motor-nerve activities. The motives corresponding to the forms of development of the interest which work in us are the material, egoistic, intellectual and moral motives.<sup>1</sup>

The relation of interest and motive is as follows: —

The *material motive* [corresponding to the physiological interest] has as its function to maintain and develop the individual in the struggle for existence until with death the nerves cease their activity. It works largely in a reflex, automatic manner. But with the development of consciousness it loses its fundamental character and, subordinated to reflection, draws on a larger circle of the world for the satisfaction of its strivings; now all the impulses co-operate to develop the individual and maintain the race. The material interest as thus developed we call the *egoistic motive* [corresponding to the individual interest] which of all the motives exercises the most definite influence on the social process. With the development of reason and the enlargement of experience, this motive is increased to embrace what is of use to every creature and to the social organization, and expanding by means of the blood-bond, comes to include the race. . . . Upon this motive of self-interest rests to an essential degree the origin, maintenance and development of social individuals; it supports culture also in the direction useful to man. This motive, moreover, is the chief force in all political events. When the individual is able to identify self-interest with that of a social institution he works all the harder to advance the conditions favorable to it, but sometimes the welfare of the individual and society come into conflict, and while the conflict is often solved instinctively, sometimes it comes into consciousness in a way to stir up the intellect, and the *intellectual motive* which deals with ideas. These ideas are all related to organic needs so the intellectual motive is an outgrowth of the process of adaptation and arises because the organism cannot adapt itself to the given situation on a lower plane of activity. . . .

These motives, as the interests, tend to function harmoniously in accordance with the principle of adaptation. When a person is lacking in the social interest every idea is bound up with self-interest. Many times, it is true, individual interest comes into the realm of intellectual struggle, but without being able to yield its egoistic bias. Intellectual motives remain pure only when they keep free from everything that has practical bearing on the social struggle. On this account the intellectual motive must be accompanied by the *moral motive* [corresponding to the social and transcendental interests] in order that it may guard the objectivity of social interests.<sup>2</sup>

<sup>1</sup> *Erkenntnis*, p. 254.

<sup>2</sup> *Ibid.*, p. 255 f.

Nowhere does the intellectual motive enter more easily into the domain of social interest than in the satisfaction of religious need. On the other hand, nowhere do inborn interests and the motives peculiar to them reveal themselves more clearly than when man endeavors to apply his religious ideas to social life. . . . Religious faith when grounded in a correct interpretation of the relation of the individual to the absolute is one of the most potent forces in life, but such faith is possessed by only a few, and only by the repeated awakening of religious sentiments is the moral emotion able to attain lordship in the interest of society.<sup>1</sup>

Individuals differ not only physiologically, but in innate mental capacity and in will power. Races, too, differ in the average of these qualities.<sup>2</sup> Men are classified as to will power into active or aggressive and passive or defensive, the latter, numerically in the majority, always subordinated to the comparatively small number of the former. This process of subordination of the many weak to the one strong will is the source of social organization.<sup>3</sup> The one strong personality formulates the line of interest-satisfaction or social purpose accepted by groups and the more or less conscious acceptance of this purpose on the part of the group is what constitutes social will.

Contrary to Gumplowicz, our author assumes a monogenetic origin of the human race out of the primates in the Tertiary period, although he admits that the process of evolution is shrouded in mystery.<sup>4</sup> The earliest stage was characterized by sociality and co-operation in a struggle against physical conditions and wild animals.<sup>5</sup> Increase of population and pressure on means of subsistence led to conflict of interests, separation and migration, and the various groups under the long continued influence of different environmental conditions developed by the law of adaptation the ethnic peculiarities which differentiated the races in earliest historic times.<sup>6</sup> The second stage, or that of *primitive culture* was characterized, industrially, by fishing and agriculture in some environmental conditions, in others by hunting, herding, or both, leading to the development of nomadic life. Socially this stage was characterized by the rise of institutions.<sup>7</sup> In the third or *barbaric stage* we find increase of numbers leading to conflict of

<sup>1</sup> *Erkenntnis*, p. 258.

<sup>4</sup> *Soziologie*, p. 27.

<sup>7</sup> *Ibid.*, p. 14.

<sup>2</sup> *Soziologie*, pp. 35 f.

<sup>5</sup> *Ibid.*, p. 13.

<sup>3</sup> *Erkenntnis*, p. 285.

<sup>6</sup> *Ibid.*, pp. 13, 30 f., 37 f., 65, 74.

interests between groups, robbery and warfare resulting in the death or enslavement of the vanquished.<sup>1</sup> The fourth or *stage of warfare* was characterized by the general practice of living by plunder and war and by the development of social organizations adapted to such a life, also by the rise of private property and by the development of rights. In the fifth stage we have the ruling classes struggling for the possession of the earth and the subject classes struggling for better conditions of life, hence a *conflict of classes* within the group, based on class interests.<sup>2</sup> In the sixth stage we have the *spread of capitalism*, an era of discovery and exploitation of new lands and the bloody conflicts between culture groups for the possession of the earth. The extension of the capitalistic system necessitates the development of credit and leads to the conflict between the capitalistic and laboring classes. It leads also to the development and spread of culture<sup>3</sup> and to the rise and rule of an aristocracy of wealth.<sup>4</sup>

A new age is coming, — an age of settled social life characterized by the harmonious organization of production. Every land will eventually need all its territory for the support of its own people so migration will cease, — except as carried on by force by the stronger groups. Each group will produce those commodities for which it is best adapted, and the whole world will be organized on a basis of free international exchange. The stronger races will increasingly dominate the weaker.

Finally, with geological changes in the earth and with the waste of the ground materials of civilization which characterizes our present age, will come a time of increasing difficulty of production which will call for a new type of human life.<sup>5</sup>

This brief sketch shows how prominent is the doctrine of adaptation in the social theory of Ratzenhofer, and how much he has contributed to the development of this theory as a key to the understanding of social evolution. We have passive material adaptation by the direct influence of the environment on the organism, leading eventually to changes in the germ plasm,

<sup>1</sup> *Soziologie*, p. 14.

<sup>2</sup> *Ibid.*, p. 15.

<sup>3</sup> *Ibid.*, p. 15.

<sup>4</sup> *Ibid.*, p. 16.

<sup>5</sup> *Ibid.*, p. 17.

hence, to permanent ethnological characters.<sup>1</sup> We have the environment working indirectly by compelling certain groups to certain kinds of industrial life and to the development of social institutions adapted to it.<sup>2</sup> We have passive material adaptation, moreover, as a result of overpopulation in proportion to means of subsistence at the disposal of the individual and group leading to conflict of interests, struggle, and the survival of those best fitted for the particular environment and stage of civilization.<sup>3</sup> We have passive spiritual adaptation by the operation of social pressure on the individual,<sup>4</sup> and in the evolution of higher civilizations and social institutions as a result of group conflict and cross-fertilization of cultures. Finally, we have active spiritual adaptation through the work of those few great thinkers who are able to attain a measure of real intellectual freedom<sup>5</sup> and become leaders to hasten, within limits, the process of natural evolution, also through organized social activity under the leadership of such rare individuals. In the latter case the result is usually attained by the organization of a new faction within the group as the center for the advancement of the desired reforms.

WALTER BAGEHOT (1826-1877)

*Discussion and Animated Moderation*

Although *Physics and Politics* was published before many of the writings already discussed, and although Bagehot makes such large use of biological formulae<sup>6</sup> that he might have been classed with that school of sociologists, his contribution is placed here because his chief interest is an inductive study of the social process,<sup>7</sup> and in this study he emphasizes two elements as all important in social progress, imitation<sup>8</sup> and discussion.<sup>9</sup> The book thus forms a logical transition from the anthropological and historical schools to those sociologists who endeavor to discover one all-important element as the key to the understanding

<sup>1</sup> *Soziologie*, pp. 37 f., 50 f.

<sup>4</sup> *Ibid.*, p. 159.

<sup>2</sup> *Ibid.*, pp. 89 f.

<sup>5</sup> *Ibid.*, p. 184.

<sup>3</sup> *Ibid.*, p. 159.

<sup>6</sup> *Physics and Politics* (New York, 1873), ch. II, p. 24.

<sup>7</sup> *Ibid.*, pp. 118 f.

<sup>8</sup> *Ibid.*, pp. 33, 100.

<sup>9</sup> *Ibid.*, ch. V.

of social evolution. Writing before Weismann, he believed with most biologists of his day in the inheritance of acquired characters although this doctrine is not essential to his argument.<sup>1</sup> He accepted in general the theory of Sir Henry Maine as to the earliest historic form of the family and state,—the patriarchal,—but he also accepted the conclusions of Bachofen, McLennan, and Lubbock, as to an earlier stage when loose sexual relations reigned along with “mutterrecht.”<sup>2</sup>

The first problem of primitive times, as Bagehot sees it, is to get law, order, polity,—“a polity first — what sort of polity is immaterial; a law first — what kind of law is secondary; a person or set of persons to pay deference to — though who he is, or they are, by comparison scarcely signifies.”<sup>3</sup> Despotism and slavery were thus angels in disguise, for they were the means of disciplining the impulsiveness of primitive man. But the nation that went too far in its legalism and its conservatism, cutting off all innovators and innovation, was doomed.<sup>4</sup>

The two essentials to social as well as biological success are, then, stability and variation, social stability resulting from imitation, — mostly unconscious, — and elimination of the disuseful;<sup>5</sup> social variation resulting from invention and free discussion.<sup>6</sup>

Bagehot wisely discriminates between the process of race making (confined mostly to prehistoric times), and that of nation making, a modern phenomenon.<sup>7</sup>

As the importance of imitation will be discussed later, we will consider here only the factors of *discussion* and *animated moderation*, which are his original contributions to sociology. Having shown the necessity of custom and custom-imitation together with the danger of over-conservatism, he says: “The change from the age of status to the age of choice was first made in states where the government was to a great and a growing extent a government by discussion, and where the subjects of that discussion

<sup>1</sup> *Physics and Politics*, pp. 7, 8.

<sup>4</sup> *Ibid.*, ch. II.

<sup>2</sup> *Ibid.*, pp. 12, 122 f.

<sup>5</sup> *Ibid.*, pp. 92, 103.

<sup>3</sup> *Ibid.*, pp. 50, 64, 137.

<sup>6</sup> *Ibid.*, pp. 65 f., 156 f.

<sup>7</sup> *Ibid.*, pp. 86, 136. “If we look at the earliest monuments of the human race, we find these race-characters as decided as the race-characters now,” *ibid.*, p. 107.



were in some degree abstract, or, as we should say, matters of principle,"<sup>1</sup> — such as those connected with religion, philosophy and politics, in the abstract.<sup>2</sup> Matters of practical social import were the first questions to be discussed, but if concerning merely methods of warfare as with the Indians, progress did not result.<sup>3</sup> The chief value of discussion, he holds, is due to the premium it puts on intelligence and its effect in promoting tolerance.<sup>4</sup>

Bagehot mentions the following as conditions that may be traced historically to the nation capable of a polity that suggests principles for discussion, and so leads to progress: —

First, the nation must possess the *patria potestas* in some form so marked as to give family life distinctness and precision, and to make a home education and a home discipline probable and possible. . . . Secondly, that polity would seem to have been created very gradually by the aggregation of families into clans or *gentes*, and of clans into nations, and then again by the widening of nations, so as to include circumjacent outsiders as well as the first compact and sacred group, — the number of parties to a discussion was first augmented very slowly. Thirdly, the number of "open" subjects, — that is, of subjects on which public opinion was optional, and on which discussion was admitted, was at first very small.<sup>5</sup>

Another valuable result that comes from discussion is a character which he terms "animated moderation."<sup>6</sup> "To act rightly in modern society," he says, "requires a great deal of previous study, a great deal of assimilated information, a great deal of sharpened imagination; and these prerequisites of sound action require much time." He shows how true this is especially in the art of benefiting men, where "haste makes waste."<sup>7</sup> Discussion, too, leads to intellectuality and this in turn by virtue of the law of conservation of energy, to limitation of population.<sup>8</sup> A final value comes from the relation of discussion to intellectual development and of this to mechanical ingenuity.

In the final chapter he shows how "a lazy nation may be changed into an industrious, a rich into a poor, a religious into a profane, as if by magic, if any single cause, though slight, or any combination of causes, however subtle, is strong enough to change

<sup>1</sup> *Physics and Politics*, p. 158.

<sup>2</sup> *Ibid.*, pp. 164 f.

<sup>3</sup> *Ibid.*, p. 166.

<sup>4</sup> *Ibid.*, pp. 162, 163.

<sup>5</sup> *Ibid.*, p. 184.

<sup>6</sup> *Ibid.*, pp. 114 f., 185 f.

<sup>7</sup> *Ibid.*, p. 188.

<sup>8</sup> *Ibid.*, p. 197.

the favorite and detested types of character.”<sup>1</sup> The qualities that go to make up the superior power of Englishmen, he holds, are these: (1) as a whole, greater command over the powers of nature, viewed not only externally by results, but internally by *ability* to do; (2) greater knowledge of how to use these forces of nature, as for example, in the interest of the health and comfort of the present body and mind. He quotes with approval Spencer’s phrase that “progress is an increase of adaptation of man to his environment, that is, of his internal powers and wishes to his external lot and life.”<sup>2</sup>

The progress of *man*, he holds, requires the co-operation of *men* for its development. If this cannot be secured, the group perishes. A second principle is that “the co-operation . . . depends on a *felt union* of heart and spirit; and this is only felt when there is a great degree of real likeness in mind and feeling, however that likeness may have been attained.”<sup>3</sup>

Bagehot grants a high place to religion in that it gives a confidence in the universe, but especially to those religions that have the most obvious effect in strengthening the races which believed them, and in making those races the winning races; but no one quality receives the meed of praise granted to *animated moderation*.<sup>4</sup>

Bagehot’s *Physics and Politics* has been one of the most widely read and quoted books in sociology and has exerted a profound and lasting influence. In it we find the author bringing out the four ideas we are presenting in this work, passive and active material adaptation and passive and active spiritual (or social) adaptation, granting to the last a far greater function in social evolution than most whose writings we have considered.

<sup>1</sup> *Physics and Politics*, p. 206.

<sup>2</sup> *Ibid.*, p. 209.

<sup>3</sup> *Ibid.*, pp. 212, 213.

<sup>4</sup> *Ibid.*, p. 220.

## CHAPTER X

### SOCIOLOGISTS EMPHASIZING ONE ALL-IMPORTANT FORMULA OR PRINCIPLE

EVER since the early Greek philosophers endeavored to find some one primal element from which the earth was evolved, there have been thinkers from time to time who have endeavored to find some formula to express, or some principle to explain social changes. Comte, as we have seen, at one time hoped to find such a principle in social phenomena comparable to gravitation in physical, and in his *Polity* he finds a near approach in *Love*. Spencer found an all-comprehensive formula in his general law of evolution, and a secondary formula in that of adaptation. With Darwin and especially with the sociological followers of Weismann, struggle and selection is all-important. Ratzel, as we have noted, finds the explanation in geographical conditions while the economic determinists, including Marx, find the key in some phase of production or distribution of wealth.

With our distinct aim to trace the development of the concept of adaptation as the key to social philosophy, we will consider in this chapter the contributions of a few representative writers, each of whom has developed some one principle as all-important for the correct interpretation of social progress. This will help us to understand the factors that make for adaptation.

In previous chapters besides some of the principles mentioned above we have considered *division of labor* together with *consciousness of supplementary difference* and *constraint* as worked out by Durkheim, *conflict* as developed by Gumpłowicz and *organic needs* or *interests* as analyzed by Ratzenhofer. In this chapter we will consider briefly Adam Smith as the forerunner of Spencer, Fiske and others in his emphasis on *sympathy* and of Tarde, Bagehot and Baldwin in the importance placed on *imitation*. We will consider Tarde and Baldwin for their development of this concept of *imitation* as the one all-important method of social

progress, the latter also for his genetic treatment of sociology by the "dialectic of growth," Drummond with emphasis on *struggle for the life of others* and Giddings as the exponent of *consciousness of kind*.

ADAM SMITH (1723-1790)

*Fellow-Feeling v. Self-Interest*

Out of the philosophical and ethical writings of Locke, Butler, Hume, Hutcheson, Paley and others, — all previous to the period selected as the starting point for our discussion, — developed the two schools of egoistic and universal hedonism<sup>1</sup> with a more or less positivistic and empirical basis. In Adam Smith's *Theory of Moral Sentiments*, published in 1759, we have a compromise between the two, both self-interest and sympathy or "fellow-feeling" being recognized as primary endowments of man. Without using the historic method emphasized so much later, or attaining the positivism of the modern period, he formulates and illustrates by numerous examples principles later supported by historical investigation. His doctrine of sympathy was given great prominence in the writings of Comte,<sup>2</sup> J. S. Mill, and Spencer, and made by Fiske, Nathaniel Shaler<sup>3</sup> and Giddings<sup>4</sup> the key to the understanding of the process of association.

Smith's distinction between custom and fashion<sup>5</sup> and his discussion of the influence of these on the individual laid the foundation for the later theories of Durkheim and Tarde; his theory of the part played in individual conduct by an appreciation of the judgment of his fellow-men<sup>6</sup> has been elaborated by recent social psychologists,<sup>7</sup> and his teaching concerning the development of fellow-feeling in ever-enlarging circles<sup>8</sup> is akin to James' doctrine

<sup>1</sup> For egoistic or scientific hedonism, Sidgwick, *Method of Ethics*, pp. 172 f. For universalistic hedonism, *ibid.*, p. 411; Thilly, *Introduction to Ethics*, pp. 163-200.

<sup>2</sup> It is insignificant that Comte set small store by any of the classical economists save Smith, and this, doubtless for one reason, because of the place he gives to sympathy.

<sup>3</sup> Especially in *The Neighbor*. Shaler connects sympathy with the sense of touch and suggests a biological reason for this connection, *ibid.*, pp. 32 f.

<sup>4</sup> With Giddings phrased "Consciousness of Kind."

<sup>5</sup> *Theory of Moral Sentiments*, pt. 5, chs. I and II.

<sup>6</sup> *Ibid.*, pp. 78 f., 307 f.

<sup>7</sup> Cf. McDougall, *Social Psychology*, ch. VII.

<sup>8</sup> *Theory of Moral Sentiments*, pp. 217 f., 381 f.

of "selves." Indeed in Smith we have a theological and metaphysical<sup>1</sup> interpretation of the principles which a hundred years or more later were to be established by historical and empirical study and interpreted in scientific terms.

Adam Smith has been given the credit of being the founder of the *laissez faire* school of economists, and to this degree he stands primarily as an exponent of passive adaptation; but while he gives prominence to wise self-interest, especially in his political economy, he criticizes severely those who make this the determining factor in social progress and raises to a prominence previously unknown the correlative and corrective doctrine of sympathy or fellow-feeling. Nor does he try to evolve the latter from the former, as did Helvetius, Bentham and others,<sup>2</sup> holding, on the contrary, that the capacity for fellow-feeling is an original endowment of man functioning contrary to self-interest under the sense of duty.<sup>3</sup>

Smith holds that etymologically sympathy includes only fellow-feeling with the sufferings of another, but practically that it includes all kinds of fellow-feeling, and that "our propensity to sympathize with joy is much stronger than our propensity to sympathize with sorrow."<sup>4</sup> This is due to its relation to individual pleasure and pain, based on the purpose of the Creator, and also on its greater social utility.<sup>5</sup>

Sympathy is the result of imagination,—of putting one's self in place of another,<sup>6</sup>—and so requires community of experience. This calls for a levelling process manifested especially in self-control on the part of those in distress.<sup>7</sup>

Judgment of propriety concerning the action of another is based on imaginary self-judgment and the sentiment of approval resulting. "If, upon bringing the case home to our own breast," he says, "we find that the sentiments which it gives occasion to

<sup>1</sup> Using these terms in the Comtean sense; cf. *Theory of Moral Sentiments*, pp. 139 f., 174, 223, 232.

<sup>2</sup> *Ibid.*, pp. 477 f.

<sup>3</sup> *Ibid.*, pt. 3, chs. II and III, especially pp. 515 f.

<sup>4</sup> *Ibid.*, pp. 4, 68, 145.

<sup>5</sup> *Ibid.*, Book I, Sect. 2, pp. 94 f., 310.

<sup>6</sup> *Ibid.*, ch. I, pp. 178 f.

<sup>7</sup> *Ibid.*, pp. 25 f.

coincide and tally with our own, we necessarily approve of them, otherwise we necessarily disapprove of them, as extravagant and out of proportion.”<sup>1</sup>

Man is so constituted that he derives pleasure not only from a perception of right, i. e., fitting or adapted to the end proposed, according to Smith, but also from an appreciation of utility.<sup>2</sup> Thus as the perception of order, harmony, system, *propriety*, *utility*, gives pleasure, whereas the perception of the opposite qualities gives pain, so also does the perception and experience of the familiar give pleasure, — hence the influence of custom and fashion on moral sentiments.<sup>3</sup>

Although merit and demerit should depend upon motive, according to our author, rather than upon results, and although the sentiment of approval or disapproval should come only from a sympathetic appreciation of motives, yet he grants that in fact the result of an act is the basis of judgment rather than motive. The explanation of this irregularity he finds in the good of the species.<sup>4</sup>

Important, too, is the emphasis placed by Smith on the truth that man desires not only approval but even more the consciousness of being worthy of such approval.<sup>5</sup> “It is only the weakest and most superficial of mankind who can be much delighted with that praise which they themselves know to be altogether unmerited. To desire, or even to accept of praise, where no praise is due, can be the effect only of the most contemptible vanity.”<sup>6</sup>

This necessity for the highest happiness, that conduct should conform as nearly as possible to one’s ideal, — which according to our author is the basis of the sense of duty,<sup>7</sup> — will be discussed later under the head of “idealization.”

Sympathy, then, according to Adam Smith, is the bond of social cohesion, the basis of moral sentiments, and the most essential factor in individual and social well-being.

<sup>1</sup> *Theory of Moral Sentiments*, pp. 25 f.

<sup>2</sup> *Ibid.*, pp. 286 f. Propriety and utility are practically identical.

<sup>3</sup> *Ibid.*, pt. 5.

<sup>4</sup> *Ibid.*, pp. 159-175.

<sup>6</sup> *Ibid.*, p. 189.

<sup>5</sup> *Ibid.*, pp. 188 ff.

<sup>7</sup> *Ibid.*, pp. 184 ff.

GABRIEL TARDE (1843-1904)

*Imitation*

The function of imitation in social progress, brought out forcibly by Adam Smith and developed by Walter Bagehot, has been emphasized as the one all-comprehensive factor by Tarde and been given almost equal prominence by Baldwin and Giddings.

As jurist Tarde observed how large a part imitation played in crime; as statistician he dealt with *recurrences, repetitions*; as psychologist he was particularly interested in the analysis of motives, and the experience and study of years finally crystallized into a cosmic philosophy which sought to explain evolution by the three related laws of repetition, opposition and adaptation, — the three subsumed under the one comprehensive law of imitation.<sup>1</sup> “Repetition, opposition and adaptation,” he says, “are the three keys which science employs to open up the arcana of the universe,” — and these, though distinct, are closely connected. “In biology, for example, the tendency of species to multiply in geometric progression (a law of repetition) forms the basis of the struggle for existence and natural selection (a law of opposition); and the appearance of individual variations, the production of various individual aptitudes and harmonies, and the correlation of parts in growth (laws of adaptation) are necessary to the functioning of both.”<sup>2</sup>

Tarde criticizes those sociologists such as Durkheim and Le Bon who deal with impersonal forces and spontaneous crowd impulses which coerce the individual, also those who emphasize the group as the unit. Mass movements according to our author, have their ultimate explanation in the inter-cerebral relations of two minds, the one reflecting the other. “It is here,” he says, “that he [the sociologist] must seek the key to the social mystery; it is from this that he must endeavor to derive the few simple but universal laws which may be distinguished amid the seeming chaos of historical and human life.”<sup>3</sup> From this point of view he refuses to accept such concepts as “social organism,” “soul of a people,” “genius

<sup>1</sup> Tarde, *The Laws of Imitation* (Trans. by Parsons), Introduction.

<sup>2</sup> Tarde, *Social Laws* (Trans. by Warren), p. 7.      <sup>3</sup> *Ibid.*, pp. 46, 47, 165.

of a people or race," as commonly used, and holds that they are merely a convenient label, or impersonal synthesis of individual characteristics and that the characters of individuals are alone real, effective and ever in activity. Thus instead of assuming as a starting point for cosmic evolution a homogeneous mass, as did Spencer, and defining progress in terms of differentiation and integration, Tarde assumes a motley array of elements, each possessing its own individual characteristics.<sup>1</sup>

Tarde takes his stand with the mathematical economists such as Walras and Jevons and insists that the intellectual and voluntary activities of the self can be measured quantitatively and that only so can sociology be a science.<sup>2</sup> This leads to a praise of the statistical method of social measurements and to the introduction of his social theory.

The evolution of the present world-order, according to our author, consists in resolving the mass *resemblances* into resemblances of detail, and in transforming the gross and obvious mass *differences* into infinitely minute differences of detail. The minute interagreement of minds and wills, which forms the basis of social life, i. e., the presence of so many common ideas, ends, and means in the minds and wills of all members of the same society at any given moment, — is due, not to organic heredity nor to mere identity of geographical environment, but rather to the effect of the suggestion-imitation process which, starting from one primitive creature possessed of a single idea or act, has passed this copy on to one of its neighbors, then to another, and so on.<sup>3</sup>

The reciprocal suggestion-imitation relation between two persons, Tarde holds, is the fundamental social fact and finds illustration in the relation of mother and child and also in that of teacher and pupil.<sup>4</sup> "The unvarying characteristic of every social fact whatever is that it is imitative. And this characteristic belongs exclusively to social facts."<sup>4</sup>

While imitation is the great principle of social uniformity, it is never exact; and the refraction of imitation rays in the individual

<sup>1</sup> *Social Laws*, p. 210.

<sup>2</sup> *Ibid.*, p. 34.

<sup>3</sup> *Ibid.*, p. 38.

<sup>4</sup> *Ibid.*, p. 41.



or group<sup>1</sup> and the new complex rays resulting from various desire-belief combinations and oppositions are the mainspring of variation and progress.<sup>2</sup>

Tarde differs from Ratzel from making the idea of a satisfier precede desire. He grants the impelling force of organic need but holds that this is a vital rather than a social factor.<sup>3</sup> The social substance or thing invented or imitated is "an idea or volition, a judgment or a purpose, which embodies a certain amount of *belief* and *desire*. Desire and belief: they are the substance and the force, they are the two psychological quantities which are found at the bottom of all the *sensational* qualities with which they combine, and when invention and then imitation takes possession of them in order to organize and use them, they also are the real social quantities."<sup>4</sup> Belief and desire according to our author are not social forces until they come to a head in invention and are transmitted by imitation. But beliefs and desires are not always supplementary or co-ordinate, coming frequently into conflict and this fact leads Tarde to a discussion of the laws of opposition.

The social forces thus classified drive individuals on by co-operation and opposition, and by struggle and survival produce ultimately a more or less complete harmony. "Any aggregation whatever," he says, "is a collection of individuals jointly adapted, either some adapted to the remainder or all to a common function. An aggregate means an *adaptate*. Moreover different aggregates which have relations with one another may be co-adapted; this constitutes an *adaptate* of a higher degree, and an infinite number of such degrees may be distinguished. For the sake of simplicity, let us distinguish merely between two degrees of adaptation; adaptation of the first degree is that which the elements of the system in question have among themselves; adaptation of the second degree is that which unites these elements to the systems which surround them, that is, to what is

<sup>1</sup> *The Laws of Imitation*, p. 22.

<sup>2</sup> *Social Laws*, pp. 100 f. For Tarde's use of "imitation" and his justification of it, including in the term *counter-imitation*, see Introduction, *Les Lois de l'Imitation*; also *Social Laws*, p. 42 n.

<sup>3</sup> *The Laws of Imitation*, p. 145.

<sup>4</sup> *Ibid.*, pp. 92, 93.

vaguely denoted by the term *environment*. The adjustment with one's self differs greatly, in phenomena of every sort, from the adjustment with others, just as self-repetition (habit) differs from the repetition of others (heredity or imitation), and as self-opposition (hesitation and doubt) differs from opposition to others (strife or competition)."<sup>1</sup> As to whether or not there is a cosmic adaptation or "teleology," Tarde says, "Henceforth the religious mind need turn no longer far away to the vast vault of heaven, there to find and worship the fathomless wisdom that moves the universe; rather, it must gaze into the chemist's crucible, and there discern the mystery of those physical harmonies that are surely the most exact and marvelous of all,—far more wonderful even than the scattered disorder of the stars: I mean the chemical combinations."<sup>2</sup>

Though man has had to give up anthropocentric cosmology he finds scope for teleological conceptions in the marvelous adaptation in the details of each organism. "There is no *single* end in nature," Tarde says, "no end in relation to which all others are means; but there is an infinite number of ends which are seeking to utilize one another. Every organism, and in every organism every cell, and in every cell, perhaps, every cellular element, has its own particular providence, for itself and in itself. Here, then, as before, we are led to consider the harmonizing force . . . not as something unique, external and superior, but as indefinitely repeated, infinitesimal, and internal. In reality, the source of all these harmonies of life, which become less striking the farther we get from the starting point and the wider the field we embrace, is the fertilized germ; this last is a living representation of the intersecting lines that meet in it, forming often a felicitous cross-breed; it is the germ of new talents, which are destined to spread broadcast and propagate themselves in turn, thanks to the survival of the fittest, or the elimination of the least fit."<sup>3</sup>

The same is true of society, he holds:—

The final outcome . . . of this final preponderance of a single line of social evolution . . . is the series of scientific discoveries and industrial inventions that have gone on ceaselessly accumulating and making use of one another;

<sup>1</sup> *Laws of Imitation*, pp. 148 f.

<sup>2</sup> *Ibid.*, p. 154.

*Ibid.*, p. 157.

these have become bound together in a system or bundle, whose real logical interrelation, though not without intricacies of its own, seems vaguely repeated in the interrelation of the races which have contributed to its formation. If we follow up this great scientific and industrial stream, we find its source in the mind of every genius, whether obscure or celebrated, who has added some new truth, some new means of activity, to the enduring legacy of humanity, and who has made the relations among mankind more harmonious by this contribution, by promoting community of thought and collaboration of effort. And so . . . I maintain that the details of human events alone contain striking adaptations; that the basis of those harmonies which are less noticeable in a vaster domain here comes plainly to view, and that the more we rise from a small but closely united social group, such as the family, the school, the workshop, the rural church, the convent, or the regiment, to the city, the province, or the nation, the less complete and striking does the solidarity become. . . . This is true, be it observed, unless some powerful personality intervenes to govern and overrule the interrelation of events. The latter, however, tends to occur more and more frequently, since civilization is distinguished by the facilities it offers for the realization of special schemes of social reorganization; and in this case it does not always hold true that the harmony of an aggregate is in inverse ratio to its mass.<sup>1</sup>

In Tarde's philosophy we have a "pluralistic universe." The ultimate fact so far as he can discover is a vast multitude of diverse primal units. These primal units or simple elements after a time form into a vast array of complex units exhibiting internal adaptation. Ultimately the complex protoplasmic organism is evolved having internal adaptation and a certain degree of external, — and so on through the development of species to man and through the family to complex social relations.<sup>2</sup> Viewed statically adaptation for the most part decreases inversely with the extent of adaptive relations, but viewed dynamically the progress of civilization reveals another movement tending to increase the closeness of human relations by association and co-operation so that we may look forward to an ultimate social organization co-extensive with humanity which shall reveal a high degree of internal adaptation.<sup>3</sup> And just as the evolution of species is explained by variation, struggle and survival, so the process of socialization is explained by social variation (invention) and imitation, working by the laws of repetition and opposition to secure ultimate adaptation. Imitation, then, with

<sup>1</sup> *Laws of Imitation*, pp. 162, 163.

<sup>2</sup> *Ibid.*, p. 162.

<sup>3</sup> *Ibid.*, p. 169.

Tarde, explains socialization much as natural selection with Darwin explains biological evolution and the origin of species.

The social ideal is well expressed in the following: —

If we take the ideas of invention, imitation and social logic as a guiding thread we are led to the more reassuring perspective of a great future confluence . . . of multiple divisions of mankind into a single peaceful human family. The idea of *indefinite progress*, which is such a vague and obstinate idea, has neither a clear nor precise meaning except from this point of view. The *necessity* of a progressive march *towards* a great but distant goal is an outcome of the laws of imitation. This goal, which becomes more and more accessible in spite of apparent, although transitory, set-backs, is the birth, the development, and the universal spread, — whether under an imperial or federated form is insignificant, — of a unique society. . . . We might demand to what extent this collective dream, this collective nightmare of society, was worth its cost in blood and tears if this grievous discipline, this deceptive and despotic prestige, did not serve to free the individual in calling forth, little by little, from the depths of his heart, his freest impulses, his boldest introspection, his keenest insight into nature, and in developing everywhere, not the savage individualities, not the clashing and brutal soul-stuffs of bygone days, but those deep and harmonious traits of the soul that are characteristic of personality as well as of civilization, the harvest of both the purest and most potent individualism and consummate sociability.<sup>1</sup>

Tarde is open to criticism chiefly in the following points: —

1. His system is essentially logical rather than factual, and he has not proven that logical classification fits life conditions. Although there seems to be a straining towards consistency in the belief-desire life of the individual, this is seldom attained, and chaos is not uncommon. The same holds of the co-adaptive process of socialization.

2. His attempt to reduce life to mechanistic terms explicable by mechanical laws fails in two particulars: (a) it leads to strict determinism making the apparent freedom of individual and social activity an illusion,<sup>2</sup> and (b) it leads to a doctrine of socio-psychical measurements which is contradicted by every-day experience. The only possible way that evaluations can be quantitatively compared is by first reducing them to their physi-

<sup>1</sup> *The Laws of Imitation*, p. xxiv.

<sup>2</sup> Especially apparent in his discussion of suggestion and auto-suggestion: "L'état social, comme l'état hypnotique, n'est qu'une forme de rêve. . . . N'avoir que des idées suggérées et les croire spontanées: telle est l'illusion propre au somnambule, et aussi bien à l'homme social," *Les Lois de l'Imitation*, p. 83.

cal correlates as is done in physiological-psychology. But this process, as Münsterberg has shown, leaves out the very heart of the phenomena compared. Evaluations differ from moment to moment, and social facts are the outcome of these ever-shifting evaluations.

3. His broad use of the term imitation is questionable,<sup>1</sup> its exact meaning left undefined and its *modus operandi* mis-explained by use of mechanical similes. Indeed his discussion of suggestion and imitation is now *passée*.<sup>2</sup>

4. He made the mistake common to many social philosophers of trying to find one all-comprehensive element or principle as a sociological solvent.<sup>3</sup>

M. M. Davis credits Tarde's social logic as giving the following valuable suggestions: "It helps us to conceive how beliefs and desires (inventions) agree, disagree, or combine, and thus, how systems of ideas are built up. We see that the social life of a people must be an organic whole because of the inherent necessity for logical harmony between those different ideas and sentiments existing in individual minds, which are represented objectively in social institutions. We see that social change must come about through the appearance and adoption (imitation) of new ideas, (inventions) which are either in harmony with the existing system, or are connected with such strong beliefs and desires that they substitute themselves for parts of this system and occasion a re-synthesis. The relative strength of such beliefs and desires determines whether or not an invention will be established socially, that is, be imitated."<sup>4</sup> Davis criticizes Tarde, however, for his over-emphasis on this one factor to the practical exclusion

<sup>1</sup> Cf. Small, *op. cit.*, pp. 626 f.; Baldwin, *Social and Ethical Interpretations*, p. 478; Wallis, *The Great Society*, p. 120.

<sup>2</sup> Cooley, *Human Nature and the Social Order*, pp. 25 f.; Wallis, *op. cit.*, pp. 131 f.; Thorndike, *Original Nature of Man*, ch. VIII.

<sup>3</sup> This criticism may be passed on the endeavor of the present writer to interpret social progress by the principle of adaptation, but this difference should be noted: The term imitation is supposed to have definite content and is used by Tarde to *explain* a process which includes innovation, repetition, opposition, and adaptation, whereas the term adaptation is used in this volume merely to describe a series of relationships existing or that should exist.

<sup>4</sup> Davis, *Psychological Interpretations of Society*, p. 22.

of others. "The general conception of social progress," he says, "is the *mutually adaptive reactions* of individuals; and that special form of adaptation which we call imitation is neither its only social form nor its only social form of importance," and quotes Cooley with approval, who says: "There are other aspects of society besides imitation which may be viewed as social processes; competition, communication, differentiation, and others, are each worthy of a volume like Tarde's *Laws of Imitation*. . . . The real process is a multiform thing, of which these are but glimpses."<sup>1</sup>

In the writings of Tarde we have an attempt to explain cosmic evolution in purely mechanical terms, hence passive adaptation is ever in the foreground, but these mechanistic forces are ever producing new compounds<sup>2</sup> hence the possibility of progress. In the human intellect these result in new ideas, and in the "heart" in new desires and sentiments, and these functioning in social life as inventions, make possible that so-called telic process which we term active adaptation.

JAMES MARK BALDWIN (1861- )

*The Dialectic of Growth*

Professor Baldwin, as Tarde, has made imitation the fundamental social process or "true type of social function," although he differs from the latter in his interpretation of the process, in his analysis of the "imitable" and in his emphasis on "reflective imitation."<sup>3</sup>

Baldwin makes his approach to social philosophy from the point of view of genetic psychology, studies the process of the development of the child's mind in contact with his social environment and from his conclusions formulates his principles of the "Dialectic of Personal Growth" and "Dialectic of Social Growth" which together form his chief contribution to our subject. In order to appreciate these principles some preliminary observations will be in place.

<sup>1</sup> Davis, *op. cit.*, p. 104.

<sup>2</sup> *L'invention*, pp. 4 f.

<sup>3</sup> *Social and Ethical Interpretations*, pp. 478 f.

As we noted in our discussion of biological evolution, Baldwin, with Osborn and Lloyd Morgan, formulated the doctrine of "Organic Selection" according to which acquired characters are considered to affect the evolutionary process either by working through the central nervous system or by the preservation of these characters through habit and social heredity until they eventuate in an inborn variation which is transmitted by physical heredity.<sup>1</sup>

Baldwin is a firm believer in the doctrine of natural selection and makes large use of it in his psychology and social philosophy, but he brings the social process into strong contrast to the biological, laying chief stress on invention, imitation, and "social heredity," and pointing out several ways in which the doctrine of natural selection fails when applied to social evolution.<sup>2</sup>

The socio-psychical process or the "modes of social or collective life" are divided into three classes: (1) the instinctive or gregarious; (2) the spontaneous or plastic; and (3) the reflective or social proper.<sup>3</sup> The instinctive or gregarious group of collective reactions are *physically inherited by individual animals*. Such modes of action, moreover, *are fixed and unprogressive and are the product of biological laws*. The spontaneous or plastic group of collective actions are "due to experience, habits of common or joint behavior *which are not inherited, but learned*. . . . These acquired modes of collective action illustrate *social transmission rather than physical heredity*. . . . The individual does not go by this method beyond what the group life has already acquired. . . . All the individuals of the group *learn the same things*; and what they learn is the body of useful actions already established in the collective life of the group. The laws of this mode of collective action are, accordingly, psychological, not merely biological." He calls this a "mode of *psychological solidarity*."

<sup>1</sup> *Social and Ethical Interpretations*, pp. 545 ff.

<sup>2</sup> *Ibid.*, pp. 57 f., 459, 462 f. "This is the great essential thing about social truth as opposed to biological fact: *it leaps the bounds of physical heredity*," *ibid.*, p. 462.

<sup>3</sup> *The Individual and Society*, p. 36. Baldwin quotes with approval Tönnies' distinction between "Gemeinschaft" and "Gesellschaft," *Social and Ethical Interpretations*, p. 486.

In the *reflective or social group* we have not merely instinctive or unconscious imitative activity, but "an intelligent judgment made with a view to consequences to be attained." Here, alone, according to our author, do we find a group of activities that may properly be called social. In this group of intelligent acts of co-operation he notes the following characteristics: (1) *They are social novelties*, yet on the whole progressive and constructive in contrast to mob action which comes under the second mode; (2) these issue in a "solidarity of intelligence, of conviction, of higher sentiment, . . . [which] takes the place of the solidarity of mere instinct or blind feeling"; and (3) the result is a solidarity of *conscious intention and voluntary co-operation*.<sup>1</sup>

These three modes are not mutually exclusive or definitely demarked. The instinctive issues in the plastic and this in the social yet all three are co-existent and overlap.

Professor Baldwin's genetic approach to social philosophy and the gist of his theory including the inter-relation of the individual and society, the dialectic of personal growth and the all-important function of imitation cannot be stated better than in his own words as found in his latest work *The Individual and Society*.

The individual comes into the world with the impulse of the history of the race behind him. He has few perfect instincts, such as many of the animals show. He is, on the contrary, plastic and educable. But his development is nevertheless to be a compromise between the two tendencies which throughout all his life represent individualism and collectivism. He has distinctly egoistic and individualistic impulses, but with them he has also positive predispositions to social life. These two germinal tendencies are to receive their more perfect adjustment, or at least a working relation, in his education and training in the habits and usages of the social group.

It is not necessary to dwell upon the more individualistic factor in his heredity; it is summed up in the word "appetite." He has a mass of tendencies which are necessary to the preservation and advancement of his vegetative and animal life. These are of necessity direct, strong, and self-seeking.

But over against these we find certain positive impulses which are of a quasi-social or gregarious sort, ready soon after birth to develop the other side of his nature. Bashfulness, shame, jealousy, are some of the more fundamental tendencies rooted in the organic structure of the human babe, which seem to reveal ancestral conditions of collective life and habit.

<sup>1</sup> *The Individual and Society*, pp. 36 f. (italics as in text).



With these go, in a more positive sense, certain great motives of action which, natural as they are and quasi-instinctive, become the tools of "socialization according to nature" very early in the individual's personal history. *Play* and *imitation*, twin brothers in the scheme of the child's hereditary impulses, come to assume, each alone and both together, a very extraordinary rôle.

By play the young animal and the child alike come into the most fruitful social relations with one another. The meaning of the varied situations of life is learned in play, under conditions free from the storm and stress of actual serious life; and thus the functions playfully exercised are developed. The great activities of later utility in the struggles of life, and in the varied social conditions of existence, are thus made ready. In play we find one of the great meeting places of the forces of individualism and collectivism.

Imitation is another great socializing function. The child naturally falls to imitating, and when once this has begun he is a veritable copying machine, turning out acts, opinions, decisions, which are based with more or less correctness upon models found in his social environment.

By imitation he gets the "feel" of things that others do, and so learns to value the safe and sane; by imitation, he tries on the varied ways of doing things, and so learns his own capacities and limitations; by imitation he actually acquires the stored up riches of the social movements of history; by imitation he learns to use the tools of culture, speech, writing, manual skill, so that through the independent use of these tools he may become a more competent and fruitful individual; finally, it is by imitation in the way of varied and effortful trial that he succeeds in being original and inventive. Of this last result, more later on; here let us note simply that imitation in its social rôle is not *mere* imitation, *mere copying*, slavish adherence to the prevalent and easy ways of doing things; that would be a superficial way of looking at this most extraordinary set of functions. Imitation to the intelligent and earnest imitator is never slavish, never mere repetition; it is, on the contrary, *a means to further ends*, a method of absorbing what is present in others and of making it over in forms peculiar to one's own temper and valuable to one's own genius.

Armed with these impulses, the weapons of competition as well as of co-operation, the young hero of the nursery begins his personal development, as a center of considerate and purposeful action. The nucleus of personality, to the outsider, is the bodily self; it is a sort of social unit; but to the individual himself, the distinction between persons as minds and persons as mere bodily presences soon springs up and takes on greater and greater significance. For this is not an inborn distinction. The sense of self is not a ready-made and perfect gift; it is a slow growth, the stages of which show in a most interesting way the interaction of the individualistic and social factors.

It begins, probably, when the child notes the capricious and seemingly lawless actions of persons, in contrast with the more regular and mechanical actions of things, such as the swinging of the pendulum, the opening and closing of the door, the rolling of the ball upon the floor. Persons do the most unexpected, the most inconsistent things. And it is these things that

attract attention and call out the impulse to imitate. The child imitates the acts of persons.

Thus he is admitted to the inside of the other's mind, as it were, and discovers that bodies are not, as minds are, centers of feeling, will, and knowledge. He makes very quickly the discovery that his own personality is likewise two-sided; that he, too, is a mind on the inside, and that that which others see of him on the outside is not the mind, but merely the physical person. He goes through a series of distinguishable processes of interpretation, all worked out in detail by the psychologist, which are of momentous significance for the evolution of personality.

Put very briefly and untechnically, these processes are in outline as follows:

The mind of others is at first to the child the source of capricious and mysterious actions and events. It is located simply in the physical person of others: it is then "projective" — simply "projected" into the other person, nurse, mother, or whoever it be.

But this sort of presence is then taken *over into himself*, by imitation, and illustrated in those more intimate experiences which are peculiar to his own mental life — pains, efforts, emotional crises, etc. These become the means by which he interprets the "projective" characteristics of others. Their inner life is understood in terms of his own. The whole set of events, having personal, and not merely physical or bodily significance, becomes "subjective"; it is peculiar to the "subject," which is now for the first time differentiated with some clearness from things.

This is followed again by a return movement. The subjective experiences, — say a series of violent efforts, or a violent pain, — are in analogous circumstances read into others also. When the emotional expression warrants it, or when cries or gestures indicate it, the subjective is made over to other persons; it is "ejected" into the individuals of the immediate *entourage*.

Other persons are thought of then in just the same terms as the private self; and the private self in the same terms as other persons; it is impossible to distinguish them, so far as the meaning in subjective terms is concerned. The thought of self is of a *larger self which includes personalities* in general, and the different persons, in all that which is not singular or characteristic of each, *are fundamentally the same*.<sup>1</sup>

This dialectic of personal growth has its analogue in the give-and-take process continually going on between the individual and society. "We see that society," says Baldwin, "stands as a quasi-personality under a two-fold relation of give-and-take to the individuals who make up the social group. It is related to these individuals in two ways: first, as having itself become what it is by the absorption of the thoughts, struggles, sentiments, co-operations, etc., of individuals; second, as itself finding its new

<sup>1</sup> *The Individual and Society*, pp. 18-26.

lessons in personal (now *social*) growth in the new achievements of individuals. If we take any lesson which society learns, — any one thought which it adopts and makes a part of its organized content, — we can trace the passage of this thought or element through the two poles of the ‘ dialectic of social growth ’ just as we can also trace the elements of personal suggestion, in the case of the analogous dialectic of the individual’s growth. The new thought is ‘ projective ’ to society as long as it exists in the individual’s mind only; it becomes ‘ subjective ’ to society when society has generalized it and embodied it in some one of the institutions which are a part of her intimate organization; and then finally society makes it ‘ ejective ’ by requiring, by all her pedagogical, civil, and other sanctions, that each individual, class, or subordinate group which claims a share in her corporate life, shall recognize it and live up to it.

“ Society, in other words, makes her particularizations, inventions, interpretations, through the individual man, just as the individual makes his through the alter individual who gives him his suggestions; and then society makes her generalizations by setting the results thus reached to work again for herself in the form of institutions, etc., just as the individual sets out for social confirmation and for conduct the interpretations which he has reached. The growth of society is therefore a growth *in a sort of self-consciousness*, — *an awareness of itself*, — expressed in the general ways of thought, action, etc., embodied in its institutions; and the individual gets his growth in self-consciousness in a way which shows by a sort of recapitulation this two-fold movement of society. So the method of growth in the two cases, — what has been called the ‘ dialectic,’ — is the same.”<sup>1</sup>

The relation between society and the individual is well expressed in these words: “ (1) Individuals can particularize only on the basis of earlier generalizations of society. This gives an initial trend to the thought-variations which are available for social use. (2) Society is absolutely dependent, as to its new acquisitions, upon the new thoughts, particularizations, of individuals; and it again generalizes them. It can get material

<sup>1</sup> *Social and Ethical Interpretations*, p. 512.

from no other source. (3) Only when both these conditions are fulfilled, — when old social matter is particularized by an individual and then again generalized by society, — can new accretions be normally made to the social content and progress be secured to the organization as a whole.”<sup>1</sup>

Professor Baldwin has contributed further to social philosophy by his analysis of “sanctions” meaning by this term “all the reasons which are really operative on the individual, in keeping him at work and at play in the varied drama of life.” Of these there are two general classes, the personal and the social. The personal sanctions are classified as *impulse, lower hedonic, desire, higher hedonic* and *right*. The social sanctions are classified as *natural, pedagogical and conventional, civil, and ethical and religious*. Our author differs from many in holding that there is no real antagonism between the individual and the social sanctions, except in the case of the “exceptional man or the exceptional judgments of the average man.”<sup>2</sup> “The actual oppositions which do arise in his life,” says Baldwin, “are rather *a propos* of questions regarding which he finds room for discussion, and for the more thoroughgoing application of the intellectual sanction.”<sup>3</sup>

Among the most important of these sanctions, according to our author, are the ethical and the religious, and in the discussion of these, use is made of the “dialectic of growth” and of the doctrine of *adaptation*.

“There can be no real opposition,” says Baldwin, “between society and the individual in the matter of the essential demands of the moral and religious consciousness. The fact of ‘publicity’ in all religious and ethical thought makes it necessary that the same ideal should be erected in the individual and in the community in which the individual is reared, since the growth of the ideal self-thought in the individual depends constantly upon the absorption of moral and religious suggestions from the social environment.”<sup>4</sup> The same is true, he holds, concerning the religious life, though he admits that historically there have been acute conflicts in the religious sphere.

<sup>1</sup> *Social and Ethical Interpretations*, p. 511.

<sup>2</sup> *Ibid.*, p. 424.

<sup>3</sup> *Ibid.*, p. 429.

<sup>4</sup> *Ibid.*, p. 434.

Professor Baldwin is open to criticism especially at two points: first, in the loose way in which he uses the term imitation and second for his failure to give definite content to those various unities that make up quasi-personalities. We have in fact different "societies" with different ideals, and as one person is brought under the influence of varying and often conflicting ideals, the result is a greater diversity and confusion in the inner life of the individual than provided for in Baldwin's theory; yet on the whole perhaps no author has contributed more to the development of the concept of adaptation as a social theory, especially as pertaining to morals and religion. To his ascending series of "struggles," — between individuals in the lower species of animals, between groups in the higher, and in human society, struggle for a living, for place, and excellence,<sup>1</sup> — we would add a final form, — *struggle for social achievement*.<sup>2</sup>

HENRY DRUMMOND (1851-1897)

*Struggle for the Life of Others*

Drummond's great contribution to social philosophy is in supplementing the law of struggle for existence with that of "struggle for the life of others" having its mainspring in that disposition or sentiment termed love. "Experience," he says, "tells us that man's true life is neither lived in the material tracts of the body, nor in the higher altitudes of the intellect, but in the warm world of the affections."<sup>3</sup> This fact which Comte emphasized in his *Polity*, Drummond endeavored to explain through biology. He shows that love is not a resultant of struggle for existence but is rooted in the primal activity of reproduction by cell division.<sup>4</sup> "Even at its dawn life is receiver and giver; even in protoplasm is selfishness and otherism."

"The two main activities of all living things," he holds, "are nutrition and reproduction. . . . The object of nutrition is to secure the life of the individual; the object of reproduction is to secure the life of the species. . . . The first has a purely personal

<sup>1</sup> *The Individual and Society*, ch. III. Cf. *infra*, ch. XIV.

<sup>2</sup> For further criticism, see *infra*, p. 308 f.

<sup>3</sup> *The Ascent of Man*, p. 215.

<sup>4</sup> *Ibid.*, pp. 225 f.

end . . . the second in a greater or less degree is impersonal; its attention is turned outwards; it lives for the future. . . . Almost the whole self-seeking side of things has come down the line of the individual struggle for life; almost the whole unselfish side of things is rooted in the struggle to preserve the life of others." <sup>1</sup>

Drummond is highly poetical in his description of this process through the lower forms of nature, but is more scientific and satisfactory when he comes to ground his conclusions in the facts of human sex relations and maternity. He finds that as in the male the productive and nutritive functions are most prominent whereas in the female the reproductive play the important rôle, so in man's life, struggle for existence finds its chief illustration, in woman's, struggle for the life of others.<sup>2</sup> This gives him background for his statement that "the passage from mere otherism, in the physiological sense, to altruism in the moral sense, occurs in connection with the due performance of her natural task by her to whom the struggle for the life of others is assigned. That task, translated into one great word, is maternity, — which is nothing but the struggle for the life of others transfigured, transferred to the moral sphere."<sup>3</sup> And this maternity, he holds, is not pre-eminently the mother of children nor of affection between male and female, but of *love*, — "of love as love, of love as life, of love as humanity, of love as the pure and undefiled fountain of all that is eternal in the world."<sup>4</sup>

With this origin, sympathy and love, he holds, are born in the home and from the home-circle extend in ever increasing relations.<sup>5</sup>

In the writings of Drummond we have the advantages and disadvantages arising from the attempt to interpret scientific processes in terms of religious faith and dogma. He has done more, perhaps, than any other one man to bridge the chasm between science and religion for the orthodox minister and layman and make them realize the possibility of seeing this orderly universe as God's world, the whole process guided by intelligence

<sup>1</sup> *The Ascent of Man*, pp. 221, 222.

<sup>3</sup> *Ibid.*, p. 258.

<sup>5</sup> *Ibid.*, pp. 265, 266.

<sup>2</sup> *Ibid.*, p. 257.

<sup>4</sup> *Ibid.*, p. 259.

and love. His writings are inspiring, — as religious writings always should be, — and tend to make the religionist more respectful in his attitude toward nature and natural law, and the scientist, if not repelled by Drummond's interpretations, more inclined to appreciate the values of life as well as life's processes; but such a method has this disadvantage: bias prejudices the mind to see not *what is* but *what is desired*. Some of his "natural laws in the spiritual world" are examples of this defect.

The chief contributions of Drummond are: (1) his explanation of sympathy and love as due to the result of biological evolution interpreted in terms of adaptation, and (2) his explanation of social organization as the outgrowth, by an analogous process, of the instincts of nutrition and reproduction.

FRANKLIN H. GIDDINGS (1855- )

*Consciousness of Kind*

Turning from the doctrine of imitation as developed from Smith through Bagehot, Tarde and Baldwin, with a suggestion of most recent lines of criticism of this doctrine by McDougall, Cooley and Thorndike, we find in F. H. Giddings not only a psychological analysis of imitation but especially, in his doctrine of *Consciousness of Kind*, the culmination of the analysis of the function of sympathy as made by A. Smith, Fiske, Drummond, *et al.*

In the social philosophy of Giddings we have a selective synthesis of the contributions of the writers we have considered, and an original contribution in his analysis of and emphasis on consciousness of kind as the fundamental social fact.<sup>1</sup> With Comte he accepts a positivistic and organic view of society;<sup>2</sup> with Spencer he makes use of general laws of cosmic evolution to explain social progress.<sup>3</sup> He accepts Durkheim's theory of constraint<sup>4</sup> with some recognition of his emphasis on consciousness of difference as

<sup>1</sup> "It is about the consciousness of kind, as a determining principle, that all other motives organize themselves in the evolution of social choice, social volition or social policy." — *Principles*, p. 19.

<sup>2</sup> *Ibid.*, p. 6.

<sup>3</sup> *Elements*, ch. XXV, especially pp. 335 f.

<sup>4</sup> *Principles*, p. 15.

a means of social cohesion.<sup>1</sup> He accepts Tarde's law of imitation, with slight modification,<sup>2</sup> and Novicow's theory of progress from physical through intellectual conflicts to ever increasing harmony.<sup>3</sup> Ward, too, with his emphasis on individual and social teleis, has left his impress,<sup>4</sup> and Baldwin with his "dialectic of personal growth," has left his;<sup>5</sup> while Bagehot's "discussion" and "animated moderation" find place though under different phraseology. He makes large use of Darwin's theory of natural selection, also, applying it to groups, ideals and institutions.<sup>6</sup>

Giddings holds that science cannot get beyond the dualism of matter and mind, this being the province of philosophy.<sup>7</sup> He is classed among the dualistic sociologists by Barth,<sup>8</sup> and his distinction between the physical and psychical is, for the most part, so clean cut as to warrant such a classification.

"All the conscious activities of mankind," according to our author, "spring from certain internal motives, such as passions, appetites, desires of various kinds, and ideas."<sup>9</sup> These motives are classified as those of *appreciation* giving pleasure through the sensory organs, and, later through mental activity; *utilization* leading to the satisfaction of the various appetites; *characterization*, leading to the satisfaction of desire for enlargement of personal life as distinguished from mere self-preservation, and the primary motive of *socialization* or the desire for companionship, sympathy, etc.<sup>10</sup>

These various motives work out the processes or practical activities through various methods: that of appreciation through the methods of response to stimuli and imitation; that of utilization through the methods of attack, impression and invention; that of characterization through the methods of persistence, accommodation and self-control; that of socialization through the method of assimilation, — all of these being so many modes of the one universal method of *conflict*.<sup>11</sup>

<sup>1</sup> *Elements*, pp. 194 f., 215, 353.

<sup>2</sup> *Principles*, pp. 15, 102 f.

<sup>3</sup> *Ibid.*, pp. 14 f.; *Elements*, pp. 346 f.

<sup>4</sup> *Principles*, p. 11.

<sup>5</sup> *Elements*, pp. 342 f.

<sup>6</sup> *Principles*, see Index.

<sup>7</sup> *Elements*, pp. 330 f.

<sup>8</sup> *Op. cit.*, pp. 183 f.

<sup>9</sup> *Elements*, p. 45.

<sup>10</sup> *Ibid.*, pp. 46 ff.

<sup>11</sup> *Ibid.*, p. 50.



Association is based on certain similarities, first, on those derived from kinship, and second, on those — mental and moral — due to similar brain organization.<sup>1</sup> As a result of this we have “a similar responsiveness of two or more individuals to the same stimulus or stimuli,” which may be analyzed into three stages of development: (1) initial responsiveness, — a mere first interest in any object as in a momentary panic; (2) persistent responsiveness which becomes a habit or fixed manner as in forms of speech and courtesy, and (3) rational responsiveness “which invokes the complex activity of all the powers of mind and will, and the varied adaptation of means to end.”<sup>2</sup>

We have not only these resemblances between individuals but a more or less articulate consciousness of them and also of differences. This consciousness, in its lowest form, is called *organic sympathy* and its contrary, *organic antipathy*.<sup>3</sup> These may be studied in animal reactions and also in the developing mind and activities of the child. There are three factors in organic sympathy, according to Giddings: “(1) like responsiveness of like individuals to the same stimulus; (2) like sensations received by like individuals from self and others; (3) the readier imitation of one another by like individuals than by those who greatly differ.”<sup>4</sup> The second factor is illustrated as follows: “The sound made by the mother’s voice has been like that made by the child’s own voice; while the sounds made by the dog and bird have been unlike those made by the child’s own voice. When the infant puts his hands together or passes them over his face, he receives in his brain certain sensations of pressure. When he passes his hands over his mother’s face and over her hands, he again receives sensations of pressure; and they are very like the sensations that he has received from his own body.”<sup>5</sup> The third factor finds illustration in the facility with which imitation operates among the like-minded and the difficulty with which it operates between antagonistic individuals or groups.

<sup>1</sup> *Elements*, p. 55.

<sup>2</sup> *Ibid.*, p. 56; cf. *Inductive Sociology*, pt. 2, ch. I.

<sup>3</sup> *Elements*, pp. 59 f.

<sup>4</sup> *Ibid.*, p. 62.

<sup>5</sup> *Ibid.*, p. 60.

Reflective sympathy arises when imitation and like response are the result of reflective, intelligent volition. "Resembling individuals not only sympathize with one another, but they know that they sympathize, and to a certain extent they are aware that their sympathy is affected by the perception of resemblance."<sup>1</sup> Two other consequences of resemblance are *affection* and *desire for recognition*.<sup>2</sup>

This four-fold mode of consciousness appears to the experiencing individual as a unitary fact and is called by our author *consciousness of kind* which he defines as "that pleasurable state of mind which includes organic sympathy, the perception of resemblance, conscious or reflective sympathy, affection, and the desire for recognition."<sup>3</sup> This, he holds, is the simplest of all the states of mind which can be called social, and its growth is the mental or subjective side of socialization, its objective side being dependent upon *communication* and *association*.<sup>4</sup>

The process of growing alike is termed *assimilation*.<sup>5</sup>

The fundamental importance of consciousness of kind in Giddings' social philosophy is seen from the following: "Consciousness of kind modifies appetite and desire. . . . [It] modifies the ideas and the desires that enter into the consciousness of integral self-satisfaction. . . . [It] modifies impression . . . and imitation."<sup>6</sup> He holds that like-mindedness must precede co-operation, and that where consciousness of kind exists, co-operation necessarily follows.<sup>7</sup> It is the basis of the form of association termed social pleasure.<sup>8</sup> Consciousness of kind is the basis of social groupings both component and constituent, the former based on likeness of type, the latter on likeness of purpose, and expresses itself according to the following law: "The social composition develops in proportion to the intensity and scope of the passion for homogeneity."<sup>9</sup> Human nature, our author

<sup>1</sup> *Inductive Sociology*, p. 64.

<sup>4</sup> *Ibid.*, pp. 68, 69.

<sup>2</sup> *Ibid.*, pp. 64, 65.

<sup>5</sup> *Ibid.*, p. 70.

<sup>3</sup> *Ibid.*, p. 66.

<sup>6</sup> *Ibid.*, pp. 70-72; cf. *Principles*, pp. 18 f.; *Inductive Sociology*, pt. 2, chs. II, III.

<sup>7</sup> *Elements*, p. 80.

<sup>8</sup> *Ibid.*, p. 89.

<sup>9</sup> *Ibid.*, p. 192.

holds, is pre-eminently social, and "its chief trait is a consciousness of kind wider and stronger than in animal groups."<sup>1</sup>

Like-mindedness is of two kinds, formal and rational. The former is seen in the popular acceptance of tradition and obedience to rules and precepts embodied in them, and is produced (1) by the tendency to accept as true the thing vividly imagined or desired, especially if believed by others in whom one has confidence, or if handed down from the past, and (2) by direct teaching and discipline.<sup>2</sup>

Rational like-mindedness is the result of criticism and the basis of public opinion. "Public opinion comes into existence only when a sympathetic like-mindedness or an agreement in belief is subjected to criticism, started by some skeptical individual who doubts the truth of the belief, or the wisdom of the agreement; and an opinion is then thought out to which many communicating minds can yield their rational assent."<sup>3</sup> The chief method of developing public opinion is by discussion, and, indeed is proportional to discussion.<sup>4</sup>

Component societies, for the most part genetic aggregations and characterized by likeness of type, are classified as families, ethnical groups (hordes, tribes, confederations) and demotic groups (families, neighborhoods, hamlets, parishes, towns, cities, states).<sup>5</sup> Constituent societies based on likeness of purpose are classified as household, clan and other tribal associations, and various civil societies and private or public associations, including political, juristic, economic, and cultural.<sup>6</sup> Although the development of component societies depends on likeness in type, that of constituent societies and of the social constitution "depends upon the growth of an appreciation of the value of variety or unlikeness in society."<sup>7</sup> Whether the like-mindedness is formal or rational determines the character of the social organization as to whether it is predominantly coercive or liberal. "Social organization is coercive," he says, "in those communities in which sympathetic and formal like-mindedness strongly

<sup>1</sup> *Elements*, p. 241.

<sup>2</sup> *Ibid.*, ch. XIV, especially pp. 152, 153.

<sup>3</sup> *Ibid.*, pp. 155 f.

<sup>4</sup> *Ibid.*, p. 156.

<sup>5</sup> *Ibid.*, pp. 179 f.

<sup>6</sup> *Ibid.*, pp. 193 f.

<sup>7</sup> *Ibid.*, p. 215.

predominate over rational like-mindedness. Conversely, social institutions are liberal, allowing the utmost freedom of thought and action to the individual only in those communities in which there is a high development of rational like-mindedness.”<sup>1</sup>

A second law enforcing his thesis that highly-developed consciousness of kind of a relative homogeneous population is necessary for the success of a democracy, is as follows: “The forms of social organization, whether political or other, in their relation to the individual, are necessarily coercive if, in their membership, there is great diversity of kind and great inequality. Conversely, institutions or other forms of social organization can be liberal, conceding the utmost freedom to the individual if, in the population, there is fraternity and, back of fraternity, an approximate mental and moral equality.”<sup>2</sup>

Efficiency in social organization is measured by benefit conferred on the members and depends upon moral qualities, together with a recognition of the value of expert knowledge (the basis of effective division of labor).<sup>3</sup> The results of such efficiency of social organization are seen “in the economic, intellectual, and moral life of the community, and especially in the development of an improving type of human personality.”<sup>4</sup> This means the emancipation of man from fear and superstition, decrease of emotionalism and impulsive action, and increase of rational sympathy and purposeful co-operation. “If . . . man is becoming ever better as a human being, more rational, more sympathetic, with an ever-broadening consciousness of kind,—then, whatever its apparent defects, the social organization is sound and efficient.”<sup>5</sup>

The socius is thus the social unit for Giddings and the social mind is nothing more than the interaction or organization of individual minds.<sup>6</sup> Taking his point of departure from English associational psychology, in sociology the association of minds is substituted for the association of ideas.<sup>7</sup>

<sup>1</sup> *Elements*, p. 219.

<sup>2</sup> *Ibid.*, p. 221.

<sup>3</sup> *Ibid.*, pp. 225, 226; cf. *Inductive Sociology*, pp. 449 f.

<sup>4</sup> *Elements*, p. 227.

<sup>5</sup> *Ibid.*, p. 230.

<sup>6</sup> *Ibid.*, pp. 117 f.; *Principles*, pp. 420 f.

<sup>7</sup> *Principles*, p. 25; Barth, *op. cit.*, p. 183.

Giddings has contributed to the development of the doctrine of passive adaptation by his analysis of the psychological basis of association, imitation and antagonism in so far as they are merely automatic, organic reactions along the line of least resistance and utility not only for the individual but for the group. He has contributed to the development of the doctrine of active adaptation by his insistence on the scientific distinction between man and society, both endowed with self-determined will, and the lower orders determined by forces from without; also by his analysis of the social process culminating in reflective sympathy, rational like-mindedness, and social will.<sup>1</sup> He gives to ideals and religion a far higher place than most whom we have considered and leaves the reader buoyed up by his manifest faith in the possibility of social reconstruction.<sup>2</sup>

Giddings is open to criticism in that he makes the individual the sociological unit, that his test of progress is individualistic and too indefinite, and that he has over-emphasized the one factor of consciousness of kind to the neglect or slighting of other factors equally important.

<sup>1</sup> *Inductive Sociology*, pt. 2, ch. IV, "Concerted Volition," also pp. 265 f.

<sup>2</sup> *Principles*, Book 4, chs. III and IV.

## CHAPTER XI

### TRANSITION FROM PASSIVE TO ACTIVE ADAPTATION

UP to this point our discussion has been confined very largely to passive adaptation in its various phases and processes and with good reason, for most men and social groups in most of their activities are devoid of forethought, yet our attention has been called repeatedly to the fact that social evolution is a process of increasing power of man over his material and spiritual environment.

Whether or not there is any break in the cosmic process warranting the distinction between passive and active adaptation is a mooted question, some holding that we have only new and increasingly complex combinations of mechanical forces, others holding that activity and consciousness go back to the primal cell, but the fact is indisputable that man as no other animal rebels against nature,  *fights*, CONQUERS, in some sense and to some degree. Man as no other animal is a dynamo for the transformation of mechanical energy drawn from the material environment to personal energy which reacts on that environment. In this respect individual men differ greatly, — so do groups. Such materialistic monists as Ernst Haeckel tell us that man is nothing more than a dynamo, — a mere machine, — whose product in personal energy is strictly commensurable with the material energy transformed. This is Ward's position as we shall see in the next chapter. "Matter is dynamic," he says, "and every time that man has touched it with the wand of reason it has responded by satisfying a want." But reason itself, according to strict monism, is only the most highly complex portion of the *human machine* and of the same stuff as all other machines, whether made of inorganic matter, or organic as in the vegetable and animal kingdoms. But granted, for the sake of argument, all that the monists claim; — granted that there was originally no distinct break between man and his pithecoïd precursor, physical,

mental or moral, the fact remains that there is such a break today. *Homo sapiens* is a distinct species. The "missing link," the hypothetical *homo alalus* of Haeckel has not been discovered,<sup>1</sup> and recent paleontological finds and psychological experiments on extant representatives of primitive culture tend to show that man for possibly two hundred thousand years has been infinitely superior to his nearest animal progenitors.<sup>2</sup> The Cro-Magnon type of the glacial period was a race of physical and probably intellectual giants,<sup>3</sup> if not also the races represented by the Dartford skull and the Galley Hill type, and even by the Neanderthal type as revealed by remains found near Elberfeld, Germany, near Le Moustier, France, and in the Island of Jersey, — going back possibly from 500,000 to 1,000,000 years. It is of greatest significance that food and implements of war were buried with some of these early remains, indicating the development of religious ideas.<sup>4</sup>

With the possible exception of the race of men represented by the Java skull (and it is more than questionable whether or not this is a normal skull, much less human), man for possibly half a million years has had a brain capacity indicating power of active adaptation, and this conclusion is strengthened by the expression of this power in tools unearthed in geological strata of the Tertiary period, according to some authorities.<sup>5</sup>

There are four methods of approach to this problem of the transition from passive to active adaptation. From the standpoint of biology and evolution we are led to inquire as to the organic variation or mutation, or group of such variations which

<sup>1</sup> Keith thinks there is some ground for believing that the Heidelberg man was devoid of speech; *Ancient Types of Man*, p. 83. Brinton, on the contrary, agreeing with the text, — *Races of Peoples*, p. 80.

<sup>2</sup> Angell, *Chapters from Modern Psychology*, Lecture VIII; *Archives of Psychology*, no. 11 (1908); Boas, *Mind of Primitive Man*, ch. IV; Keane, *The World's People*, p. 4; Dawson, *The Meeting Place of Geology and History*, pp. 61 f.

<sup>3</sup> Keith, *op. cit.*, ch. VII; cf. also, pp. 33 f., 83 f., 105 f.

<sup>4</sup> Marett, *Anthropology*, p. 80.

<sup>5</sup> Cf. Keane, *op. cit.*, p. 7. Haddon to the contrary, *History of Anthropology*, p. 94, yet he says: "During the latter half of the paleolithic age there lived mighty hunters, skilful artists, big-brained men, who laid the foundations upon which subsequent generations have built," *ibid.*, p. 90.

provided the physiological correlate of the psychical change we are endeavoring to explain and we find many different anatomical factors championed as the most important. Darwin stresses erect posture and prehensile thumb; Heineman holds that the mutation which made erect posture possible was in the entocuneiform bone and position of the foramen magnum, and that this change, forcing man from the tree life of his ancestors, left him at so great a disadvantage in the struggle for existence that success was possible only by the use of the little intelligence he possessed to outwit his rivals, this necessity and use determining the whole succeeding order of his evolution;<sup>1</sup> others, on the contrary, hold that the development of the intellect came first and led to a new mode of life in a new environment and that this furnished the occasion for physiological variations and the selection of those that were especially serviceable. Delay in the closing of the sutures of the skull was an important factor,<sup>2</sup> so too, were the development of the apparatus of speech, the organ of speech located by Broca in the third frontal convolution of the brain,<sup>3</sup> the nervous connection between the organ and the apparatus, the development of the cerebrum, and the free use of the forearms made possible by erect posture and terrestrial life.

Approaching the problem from the standpoint of psychology we have two lines of study, the first using the comparative method with the endeavor to find the differential psychical element between man and beast, and here the power of abstraction and association of ideas seems at present to be most stressed; and second, the method used by Baldwin and others, of observing the steps in the child's mind by which the transition is made from reflexive and instinctive activity to that which is self-conscious and purposeful.

From the sociological point of view we have a study of the materials furnished by the development of civilization as a whole, of separate groups and of contemporary social movements, by means of which we are able to analyze the social factors that enter into the transition.

<sup>1</sup> *The Physical Basis of Civilization*, p. 31.

<sup>2</sup> Keane, *Ethnology*, ch. III.

<sup>3</sup> Macnamara, *Human Speech*, ch. X.



The fourth approach is through philosophy with the endeavor to find an adequate ground for and explanation of the cosmic process culminating in free intelligence. Most biologists and sociologists assume that this process is one and continuous, to be described and explained in the terms of exact science, but Huxley,<sup>1</sup> Wallace,<sup>2</sup> Sir Oliver Lodge, Professor McDougall<sup>3</sup> and scores of others protest that not chemical affinity, natural selection nor any other known law or laws has explained the transition from the inorganic to the organic, from matter to mind, from instinctive activity to that which is conscious and purposeful, — from determinism to free choice. Positivists, on their part, assure us that though the rationale of this process is not yet clear in all its details, yet that the only way of ever even approximating the desired goal is by means of the assumptions and methods used by them. But the fact still remains that mind and matter appear to be entirely different and that in the realm of the psychical no one has yet solved the mystery of man's consciousness of, or at least belief in, uncaused freedom, — except to hold that it is a serviceable illusion.

Professor Ward claims to have explained the transition from matter to mind and from instinctive to intelligent behavior but at best he has merely described the process and analyzed the elements that have entered into it, — and this, too, in language that in places reads more like poetry than science. Spencer in

<sup>1</sup> "Force and matter are paraded as the Alpha and Omega of existence. . . . All this I heartily disbelieve. . . . It seems to me pretty plain that there is a third thing in the universe, to wit, consciousness, which . . . I cannot see to be matter, force, or any conceivable modification of either." — *Evolution and Ethics*, p. 130.

<sup>2</sup> "The special faculties we have been discussing clearly point to the existence in man of a spiritual essence or nature, capable of progressive development under favorable conditions. On the hypothesis of this spiritual nature superadded to the animal nature of man, we are able to understand much that is otherwise mysterious or unintelligible in regard to him, especially the enormous influence of ideas, principles, and beliefs, over his whole life and actions." — *Darwinism*, p. 474.

<sup>3</sup> Professor McDougall, in his latest book, *Body and Mind*, shows how completely inadequate is monism, either materialistic or spiritualistic, to explain cosmic evolution, and how far short it comes, — and so, too, all theories of psychophysical parallelism, — of enabling us to understand such phenomena as unity of consciousness and attention, adopting as his own theory what he calls "animism" — very like the "vitalism" of Driesch.

planning his cosmic philosophy deferred to a later time the volume that was to describe the change from the inorganic to the organic, but never wrote it. The nearest he comes to an explanation of psycho-physical parallelism is in a letter in which he makes use of a very apt illustration<sup>1</sup> to suggest the parallelism but admits that we must assume that both the physical and psychical are dependent on the Eternal Source of Energy which is behind both processes.

We have noted the assumptions of Ratzenhofer that the original force is ever expanding and attaining new forms of life in proportion as the conditions and elements are provided by the environment; indeed most spiritualistic monists assume that the transition is possible because the world-ground is intelligent. But even so, the change is still left a mystery. We must conclude that at present we can at most but describe the process in terms of sequence. Nor will a mere logical classification of elements that enter in suffice for this. We must assume, provisionally, that for scientific purposes this is a law-abiding cosmic order and in the spirit of Darwin endeavor to find the various elements, locate the stages of development and their order of sequence. But we may still hold that this fails to give us the life of values of conscious experience.<sup>2</sup>

The crucial point in the transition process from passive to active adaptation in its higher manifestations, is the power of choice between two apparently different courses of action. Practically all monists tell us that all we mean by freedom of choice is that it is determined by individual character rather than by outward constraint; but this fails to satisfy. The logical conclusion,

<sup>1</sup> Duncan, *Life and Letters of Herbert Spencer*, pp. 237-239.

<sup>2</sup> Compare with this the conclusion of Professor Henderson of Harvard in his book, *The Fitness of the Environment*: "We may be sure that, whatever successes science shall in future celebrate within the domain of teleology, the philosopher will never cease to perceive the wonder of a universe which moves onward from chaos to perfect harmonies, and, quite apart from any possible mechanistic explanation of origin and fulfilment, to feel it a worthy subject of reflection. From this point of view, however, science need expect no interference, but without any last vestige of former shackles may pursue the search after mechanistic explanations of all natural phenomena," p. 311. He quotes Royce with seeming approval.

as Ward saw, is fatalism. According to this theory, when I awake in the morning some sense impression from without, some idea-suggestion from within, or some organic need sets going a psychical process which with its correlated activities fills the period of conscious activity during my waking hours. Every phase of that process is strictly determined. If I deliberate on a proposed course of action, I can neither prolong the deliberation nor bring it to a close until the proper combination has been reached which results in action. I am but a part of a machine, — a part, however, that has become conscious, — and strange to say deluded into the belief that I am more than a mere machine. Man is saved from despair by this illusion.

Now the ultimate solution of this whole question is metaphysical, hence outside the domain of social philosophy, yet one phase of it belongs to our consideration. What are the relative consequences of consistent monism and libertarianism (of some sort) on human well-being and group success? Let us suppose two competing social groups. In one we have all the adults consistent monists believing that every thought and act is a part of a strictly deterministic system; that at any crucial point in individual life the ultimate decision might have been foreseen by one who knew all the elements within the mind and in the environment without. The only responsibility of the individual, then, is to society. The feeling of responsibility is a purely social product. In the other group, while granting that heredity and environment determine very largely that character which in turn determines choice, there is still belief that by a sheer act of will the individual may tap new reservoirs of energy which will give him some new grip on life and life's tasks.<sup>1</sup> The people in this group believe that there is at least power to prolong or close a mental conflict involving a great decision; this decision, in turn, having the potency of changing the whole current of life. Which group will be most productive, increase most rapidly in wealth, numbers, power? Which group will win out in the long run?

<sup>1</sup> This view is very like that of James, *Energies of Men*, of Royce, *The Spirit of Modern Philosophy*, Lecture XII, and *The World and the Individual*, Lecture X, also of Bowne, *Personalism*.

After thousands of years of inter-group conflict and cultural development, the common-sense philosophy of the winning groups is essentially libertarian. Historically, fatalism has led to stagnation and decay. If belief in freedom is necessary, and this belief is nevertheless a delusion, then this is not a rational universe, but rests ultimately on falsity not truth.

Social philosophy must rest its case on this pragmatic test: The ultimate truth as to the relation between mind and matter, and the ground of distinction between passive and active adaptation will be based on that philosophy which is most inspiring to man. Science can give us at best but relations of co-existence and sequence between phenomena. Our ultimate explanation is hyper-scientific, — a matter of belief.

One author, John Fiske, deserves special consideration in the treatment of this subject because he has brought to light a bio-sociological factor of first importance in the transition from passive to active adaptation in the individual, and as in other cases we will glance at his general social philosophy before taking up his specific contribution.

#### JOHN FISKE (1842-1901)

##### *Prolongation of Infancy*

This great American disciple and interpreter of Herbert Spencer varied from the teaching of his master in some points and at others supplemented and developed it. Accepting the evolutionary formula as a test of social progress he places more stress than did Spencer on a secondary test, — “the continuous weakening of selfishness and the continuous strengthening of sympathy,” — thus reminding us of Comte. He goes beyond his master in his analysis of the spiritual environment which conditions the life of every individual and social group, but makes advance especially in the importance he places on the psychical factors in social evolution, coming to highest expression in the purposeful activity of men and in the organization of groups.<sup>1</sup> A spiritualistic monist and deeply religious, he stresses

<sup>1</sup> *Outlines of Cosmic Philosophy*, ii, chs. XXI, XXII.

the importance of religion in life and the conscious endeavor of the individual to conform his life to the divine will. Fiske was a bitter opponent of such teachings as those of Haeckel and Ward that minimize the importance of man's place in nature, for he looks upon humanity as the flower of cosmic evolution up to man, and the perfection of humanity as the goal of social progress. "Once dethrone humanity," he says, "regard it as a mere local incident in an endless and aimless series of cosmical changes, and you arrive at a doctrine which, under whatever specious name it may be veiled, is at bottom neither more nor less than atheism. On its metaphysical side, atheism is the denial of anything psychical in the universe outside of human consciousness."<sup>1</sup>

Of greatest importance to the present subject is his discussion of the change in the cosmic process with the evolution of man. "When humanity began to be evolved," he says, "an entirely new chapter in the history of the universe was opened. Henceforth the life of the nascent soul came to be first in importance, and the bodily life became subordinated to it. Henceforth it appeared that, in this direction at least, the process of zoölogical change had come to an end, and a process of psychological change was to take its place. Henceforth along this supreme line of generation there was to be no further evolution of new species through physical variation, but through the accumulation of psychical variations one particular species was to be indefinitely perfected and raised to a totally different plane from that on which all life had hitherto existed. Henceforth, in short, the dominant aspect of evolution was to be not the genesis of species, but the progress of civilization. . . .

"In the human organism physical variation has well-nigh stopped, or is confined to insignificant features, save in the gray surface of the cerebrum. The work of cerebral organization is chiefly completed after birth as we see by contrasting the smooth, ape-like brain surfaces of the new-born child with the deeply furrowed and myriad-seamed surface of the adult individual

<sup>1</sup> *Destiny of Man*, pp. 12, 13, yet cf. *Cosmic Philosophy*, ii, p. 230, where he points out the value of skepticism.

brain. The plastic period of adolescence, lengthened in civilized man until it has come to cover more than one-third of his lifetime, is thus the guaranty of his boundless progressiveness. . . .<sup>1</sup> In its crude beginnings the psychical life was but an appendage to the body, in fully-developed humanity the body is but the vehicle for the soul."<sup>2</sup>

Fiske goes on to show the necessity of prolongation of infancy with the development of higher forms of animal life, in order that the organism may adjust itself to the ever increasing complexity of its environment. In lower forms the reactions are automatic or instinctive, but such are not sufficient for higher forms which must learn by experience, and a prolonged infancy affords a period of training so that when independent life is entered upon the organism will have a fair chance of survival. "While the nervous connections accompanying a simple intelligence are already organized at birth," he says, "the nervous connections accompanying a complex intelligence are chiefly organized after birth. . . . Infancy, psychologically considered, is the period during which the nerve connections and correlative ideal associations necessary for self-maintenance are becoming permanently established. Now this period, which only begins to exist when the intelligence is considerably complex, becomes longer and longer as the intelligence increases in complexity. In the human race it is much longer than in any other race of mammals, and it is much longer in the civilized man than in the savage."<sup>3</sup>

According to our author this prolongation of infancy had a profound sociological effect in uniting the parents in a more permanent family life required for the protection of the helpless infant, in this way developing sympathy, the basis of sociality. "Thus we cross the chasm which divides animality from humanity, gregariousness from sociality, hedonism from morality, the sense of pleasure and pain from the sense of right and wrong."<sup>4</sup> The prolongation of infancy is of vital importance, then, not only in the development of the nervous system and its acquirement of modes of activity making for adaptation, but in the establish-

<sup>1</sup> *Destiny of Man*, pp. 30, 56.

<sup>2</sup> *Ibid.*, p. 65.

<sup>3</sup> *Cosmic Philosophy*, ii, p. 342.

<sup>4</sup> *Ibid.*, p. 346.

ment and maintenance of family life, a training school of greatest value in social adjustment.

With the genesis of permanent family relation, according to our author, the evolution of man may be said, in a certain sense, to have been completed. We thus have three stages in biological evolution, the organic, including the development of the brain, the psychical beginning in the organic and continuing to the establishment of the family including the training of children, and the social, having to do primarily with man in his extra-family relations.

Fiske has contributed to our subject by the comprehensive way he has used the concept of adaptation to explain social evolution, although almost entirely in the passive sense, clarifying and expanding some of Spencer's unclear statements and making many valuable additions. He places more stress than the latter on the power of the great man<sup>1</sup> though he believes that this power is limited by the general trend of the age and character of the group to which the man belongs, and gives greater prominence to man's control over nature.<sup>2</sup>

Our author applies the doctrine we are considering to man's adjustment to his social environment using the phrase *moral adaptation*, also to man's knowledge and use of natural law under the term *intellectual adaptation*, — here approaching the use of the concept in its active sense.<sup>3</sup> Finally, he applies the theory to man's conscious endeavor to harmonize his life with the cosmic spirit, — a process he discusses under the caption "Religion as Adjustment," though his God is not more definite than Spencer's Unknowable.<sup>4</sup> His chief contribution, however, as already intimated, is his analysis of the sociological significance of the prolongation of infancy.

<sup>1</sup> *Excursions of an Evolutionist*, pp. 183 f.

<sup>2</sup> *Destiny of Man*, p. 33.

<sup>3</sup> *Cosmic Philosophy*, ii, p. 252.

<sup>4</sup> *Ibid.*, pt. iii, ch. V.





PART IV

ACTIVE MATERIAL ADAPTATION



## CHAPTER XII

### INVENTION AND PRODUCTION

ACTIVE adaptation as a process was defined in our Introduction as the "purposeful modification of any organic or quasi-organic unity to suit it to its environment, or the purposeful modification of the environment to make it favorable to the unity." In the preceding chapter we noted the difficulty in drawing any line between passive and active adaptation, so here we have the same difficulty in distinguishing between activities that are deliberately purposeful and those that are the outcome of a personal life acting occasionally with forethought but usually as a result of impulse and habit. Though foresight and purposeful activity are the flower of the process of human development, their beginning far outdates history,—indeed they are to be found among the lower orders.

For practical purposes, then, active material adaptation will comprise the whole process of industrial development, or about what Professor Ward includes under the term material achievement.

As representative writers who have laid supreme emphasis on material achievement as the basis of cultural, or on material adaptation as the basis for spiritual (including social) development, we will consider in this chapter the social theories of Ward, Simon N. Patten, and Carver.

#### LESTER FRANK WARD (1841-1913)

##### *Material as the Basis of Spiritual Achievement*

Professor Ward has the most thorough-going system of any English writer since Spencer, including as it does *Dynamic Sociology*, *Psychic Factors in Civilization*, *Outlines of Sociology*, *Pure and Applied Sociology*, and *Glimpses of the Cosmos*.<sup>1</sup>

<sup>1</sup> Posthumous work now in press.

A geologist and botanist of authority, Professor Ward was an ardent admirer and disciple of Darwin, but in the controversy between the neo-Darwinian and neo-Lamarckian schools he ranged himself with the latter, holding that there was a "bathmic-force" ever pushing out to larger life expression and to new forms, accepting also the principle of use-inheritance.<sup>1</sup>

In philosophy a strict monist, he endeavored to interpret life in terms of the inter-action of mechanical forces. A great admirer of Comte, he made use of his "hierarchy of the sciences" and like Comte emphasized the affectional nature as the dynamic of social evolution, even conceiving feeling as a cosmic force, — a function of the world-soul. Unlike Comte with whom cosmic evolution culminated in humanity and whose philosophy eventuated in the worship of humanity as the Great Being, Professor Ward considered humanity as but an incident in the cosmic process and the love of nature as the highest type of religious sentiment.<sup>2</sup>

The greatest contribution of Professor Ward to social philosophy is his stress on the all-importance of the intellect in social evolution making possible permanent human achievement, this being the characteristic which differentiates man and society from lower orders of creation, and sociology from the other sciences.<sup>3</sup> Nature in its processes, he holds, is wasteful. Man is an economizer.<sup>4</sup> He alone is an *economic animal*. To be sure human intelligence is rooted in animal intelligence, with no break in the process, but man is characterized by forethought, — telic activity.

Our author endeavors to explain or at least describe the process by which the cosmic soul evolved into the human soul as follows: —

The birth of the soul was the dawn of the psychic faculty. It marks an era in the cosmical history of the earth. Dimly and imperceptibly it worked through the primordial ages in the Silurian mollusk, the Devonian fish, and the Mesozoic reptile, producing scarcely any modification in the normal course of biologic evolution. During all these vast eons of time the only organic products of beauty or utility were such as nature in her objectless

<sup>1</sup> In later life he accepted De Vries' mutation theory.

<sup>2</sup> *Pure Sociology*, p. 430.

<sup>3</sup> *Ibid.*, pp. 17 f.

<sup>4</sup> *Ibid.*, pp. 470, 471.

march chanced to produce. But with the advent of the highly developed insects in late Cretaceous and early Tertiary time the psychic factor began to react upon the plant world, and . . . flowers were the direct product of a growing aesthetic faculty, — the response to the demands of a true soul force in nature. Later the same agency, working in bird life and mammalian life ushered in the rich, showy and nutrient fruits of the forest and the bread-yielding grains of the meadow and the marsh. The wonderful revolution wrought by this same growing soul in relations of the sexes among the creatures last mentioned . . . might fittingly form the theme of the future poetry of science. In human society . . . the soul is the great transforming agent which has worked its way up through the stages of savagery and barbarism to civilization and enlightenment, the power behind the throne of reason in the evolution of man.<sup>1</sup>

Let us consider briefly Professor Ward's contributions to our subject: —

1. *Sympodial Development*. — After contrasting sympodial with monopodial development in biology which results in the former case in a zigzag instead of linear development, he applies the principle to social development as follows: —

We may look upon human races as so many trunks and branches of what may be called the sociological tree. The vast and bewildering multiplicity in the races of men is the result of ages of race development, and it has taken place in a manner very similar to that in which the races of plants and animals have developed. . . . Every one of these races of men, from the advanced nationalities . . . back to the barbaric tribes that arose from the blending of hostile hordes, is simply an anthropologic sympode, strictly analogous to the biologic sympodes.<sup>2</sup>

This leads Professor Ward to a distinction between specialization and evolution: “The former consists chiefly in modification of form and size without change in the type of structure. The latter depends entirely on modification in the type of structure to adapt it to changes in the environment.” The former is merely natural growth and progressive adaptation to a slightly changing environment, the latter a more radical change such as is necessary for continuous adjustment to a marked change in the environment.

Ward shows that highly specialized forms are more or less unstable. “The highly specialized forms do not degenerate or

<sup>1</sup> *The Psychic Factors of Civilization*, pp. 48, 49.

<sup>2</sup> *Pure Sociology*, pp. 76, 77.

retrograde at all, but perish as they were, being simply crowded out of existence. What persist are the unspecialized forms of the same type that were contemporary with the specialized ones, but escaped competition because not specialized." <sup>1</sup> Ward goes on to show how this principle applies to races.

Races and nations become overgrown and disappear. Peoples become over specialized and fall an easy prey to the more vigorous surrounding ones, and a high state of civilization is always precarious. Races and peoples are always giving off their most highly vitalized elements and being transplanted to new soil, leaving the parent country to decline or be swallowed up. . . . Race and national degeneration or decadence means nothing more than this pushing out of the vigorous branches or sympodes at the expense of the parent trunks. The organicists see in colonization the phenomenon of social reproduction. This is at least a half truth. Colonization often means regeneration; it means race development; it means social evolution.<sup>2</sup>

Thus from England has grown the United States, Canada, Australia, South Africa. Even should England perish as a nation, her civilization, her ideals, her achievements would live on. With Ward this social process and social progress is more important than the continued existence of the sovereign group.

2. *Creative Synthesis*. — This contribution of Professor Ward comes next in order in *Pure Sociology* and introduces us to his cosmic philosophy. He compares cosmic creation to chemical combination which results apparently in something different from a sum of the causes that enter into the compound. "The only rational or thinkable idea of creation," he says, "has always been that of putting previously existing things into new forms."<sup>3</sup>

Ward assumes that the initial force differentiates and that later portions come together forming ever new combinations and that thus the cosmic order is ultimately evolved culminating in the free intelligence of man.

The synthetic creations of nature have their characteristic properties or modes of acting, and it is through these that they produce effects. Taken together these active properties constitute the forces of nature. These separate and apparently different forces are, however, only so many modalities of the one universal force, but it is not only convenient but practically correct to treat them as distinct. . . . Man possesses feeling in common with

<sup>1</sup> *Pure Sociology*, p. 78. Such analogical reasoning, while suggestive, turns the attention away from a study of the real social causes that produce the results.

<sup>2</sup> *Ibid.*, p. 79.

<sup>3</sup> *Ibid.*, p. 81.

the lower animals, and it is important to note . . . that feeling constitutes the dynamic agent, and is therefore the highest attribute that we have to consider so long as we are dealing with the dynamic agent. . . . Now feeling is a true cosmic force . . . and constitutes the propelling agent in animals and in man.<sup>1</sup>

Feeling is used by Ward in two different senses: as the *property of self-awareness* which is the chief differential attribute of the animal,<sup>2</sup> and as a force or the *dynamic agent in animal and human evolution*.<sup>3</sup> It would seem as though Ward were guilty of the fallacy of the universal and like Spencer confuses logical classification with ontological reality. Because man has a multitude of specific feelings and because animals behave as though they had inner experiences similar to man does not prove that feeling is one force, something like gravitation, always acting, and a common antecedent to all activity. There is a general sense of awareness which Ward considers as feeling; there is a certain vital feeling or awareness of the general operation of vital processes, especially the vegetative, according to Höfding,<sup>4</sup> and there is the consciousness of certain specific agreeable or disagreeable states or experiences, but there is no warrant for assuming a general feeling, as a force. Thought, feeling and will are class terms. The phenomenal realities are specific thoughts, specific feelings, and specific attitudes which eventuate in action. These are all functions of personality. To assume feeling as a force presupposes a cosmic personality that feels, but this is contrary to Ward's philosophy.

3. Ward's third contribution is his doctrine of *synergy* which he explains as follows:—

Just as in biology the world was never satisfied with the law of organic evolution worked out by Goethe and Lamarck until the principle of natural selection was discovered which explained the workings of that law, so in sociology it was not enough to formulate the law of social evolution, however clear it may have been, and the next step has been taken in bringing to light the sociological homologue of natural selection which explains the progress of

<sup>1</sup> *Pure Sociology*, p. 99.

<sup>2</sup> *Ibid.*, pp. 95, 124 f. For criticism of Ward's theory of the dynamic agent and of social forces, see E. C. Hayes, *Publications American Sociological Society*, vol. v.

<sup>3</sup> *Ibid.*, p. 99.

<sup>4</sup> *Psychology*, p. 97. Cf. Small's criticism, *General Sociology*, pp. 532 f.

social evolution. That principle is not the same as natural selection, but it serves the same purpose. It also resembles the latter in growing out of the life-struggle and in being a consequence of it; but, instead of consisting in the hereditary selection of the successful elements of that struggle, it consists in the ultimate union of the opposing elements and their combination and assimilation. Successively higher and higher social structures are thus created by a process of natural synthesis, and society evolves from stage to stage. The struggling groups infuse into each other the most vigorous qualities of each, cross all the hereditary strains, double their social efficiency at each cross, and place each new product on a higher plane of existence. It is the cross-fertilization of cultures.<sup>1</sup>

This theory, developed more at length by Gumplowicz and Ratzehofer, is especially valuable as an antidote to the over-worked natural selection theory of the biological sociologists though the materialistic postulates on which it rests are questionable.

A further quotation from Ward is necessary to appreciate his doctrine of synergy:—

The true nature of the universal principle of synergy pervading all nature and creating all the different kinds of structure that we observe to exist . . . is a process of *equilibration*, i. e., the several forces are first brought into a state of partial equilibrium. It begins in collision, conflict, antagonism, and opposition, but as no motion can be lost it is transformed, and we have the milder phases of antithesis, competition and interaction, passing next into the *modus vivendi*, or compromise, and ending in collaboration and co-operation. . . . Synergy is the principle that explains all organization and creates all structures.<sup>2</sup> . . .

Upon the perfection of these structures and the consequent success with which they perform their functions depends the degree of social efficiency. In the organic world the struggle has the appearance of a struggle for existence. The weaker species go to the wall and the stronger persist. There is a constant elimination of the defective and survival of the fittest. On the social plane it is the same, and weak races succumb in the struggle while strong races persist. But in both cases it is the best structures that survive. The struggle is therefore raised above the question of individuals or even of species, races and societies and becomes a question of the fittest structures. We may therefore qualify Darwin's severe formula of the struggle for existence and look upon the whole panorama rather as a *struggle for structure*.<sup>3</sup>

Another name for social structures is *human institutions*,<sup>4</sup> and the function of these is the control and utilization of social

<sup>1</sup> *American Journal of Sociology*, xii, p. 585; cf. *Pure Sociology*, pp. 171 f.

<sup>2</sup> *Pure Sociology*, p. 175. It is by no means certain that mechanical principles work in social processes as indicated in this quotation.

<sup>3</sup> *Ibid.*, p. 184.

<sup>4</sup> *Ibid.*, pp. 185 f.



energy in the interest of the greatest possible sum total of pleasure over pain.

4. *Individual and Social Telesis*.—Closely linked with creative synthesis is his doctrine of individual and social telesis or anthropoteleology as against theo-teleology of popular religion, yet this does not indicate that Ward believes in arbitrary freedom of the will. All acts are but parts of a cosmic process and the result of the inter-action of mechanical forces.<sup>1</sup> This doctrine is explained as follows:—

Progress below the human plane is altogether genetic and is called development. In the earlier human stages it is mainly genetic, but begins to be telic. In the later stages it is chiefly telic. The transition from genetic to telic progress is wholly due and exactly proportional to the development of the intellectual faculty. . . . There are two kinds of telic progress, or telesis, individual and collective. The former is the principal kind thus far employed. The latter is as yet so rare as to be almost theoretical. Society itself must be looked upon as mainly unconscious. . . . The intermediate step between individual telesis and social telesis is an organization of individuals into a limited body. . . . If a small number of individuals may think and act for a common purpose, a larger number may, and there is no necessary limit until the totality of a people is embraced in the number.<sup>2</sup>

Having surveyed briefly some of the main principles of Ward's social philosophy we are prepared to consider the one that is most important of all so far as our subject is concerned, viz., that form of telesis which he calls *human achievement*. This is of two kinds, material and spiritual, the latter the flower of the former. "The subject matter of sociology," he says, "is human achievement. It is not what men are, but what they do."<sup>3</sup> He differentiates *biological and social evolution* by a formula with which we are familiar: "The formula that expresses this distinction the most clearly is that *the environment transforms the animal, while man transforms the environment*."<sup>4</sup> That is, in one case we have *passive material adaptation*; in the other, *active material adaptation*. Civilization is defined as the sum total of human achievements, material and spiritual. "Material civilization," he says, "consists in the utilization of the materials and forces of nature.

<sup>1</sup> *Pure Sociology*, ch. III, pp. 465 ff.

<sup>2</sup> Dealey and Ward, *Text-book*, pp. 267, 268.

<sup>3</sup> *Pure Sociology*, p. 15.

<sup>4</sup> *Ibid.*, p. 16.

. . . The spiritual part of civilization is at least conditioned upon material civilization." "It does not derogate from its worth," he continues, "to admit that without a material basis it cannot exist; . . . but the moment such a basis is supplied it comes forth in all ages and races of men. It may therefore be regarded as innate in man and potential everywhere, but a flower so delicate that it can only bloom in the rich soil of material prosperity. . . . No amount of care devoted to it alone could make it flourish in the absence of suitable conditions, and with such conditions it requires no special attention. It may therefore be dismissed from our consideration, and our interest may be centered in the question of material civilization, and this will be understood without the use of the adjective."<sup>1</sup>

"Involved in the idea of achievement,"<sup>2</sup> he says, "is that of permanence. Nothing that is not permanent can be said to have been achieved, at least in the sense in which that term is here employed. Now, material goods are all perishable. . . . Achievement does not consist in wealth. Wealth is fleeting and ephemeral. Achievement is permanent and eternal. . . . The products of achievement are not material things at all. As said before, they are not ends but means. They are methods, ways, principles, devices, arts, systems, institutions."<sup>3</sup> In a word, they are *inventions*. . . . It is anything and everything that rises above mere imitation and repetition. Every such increment to civilization is a permanent gain, because it is imitated, repeated, perpetuated, and never lost. It is chiefly mental or psychical, but it may be physical in the sense of skill."<sup>4</sup> He enumerates and discusses other forms of achievement such as language, literature, philosophy, science, the invention of tools, instruments, utensils, missiles, traps, snares and weapons crowned by the products of the modern era of machino-facture with power of artificial

<sup>1</sup> *Pure Sociology*, p. 18.

<sup>2</sup> *Ibid.*, pp. 22 ff.

<sup>3</sup> Institutions, however, are not permanent as he himself says on p. 31. The only permanent thing is the process itself or intelligence that is its source. Cf. Bradley, *Appearance and Reality*, ch. V; Bowne, *Metaphysics*, ch. III. For criticism of this doctrine of achievement, see Gillette, *American Journal of Sociology*, July, 1914.

<sup>4</sup> *Pure Sociology*, p. 25.

locomotion and electric-intercommunication. The process by which achievement is handed down is called social heredity; and the personality who is the source of social variation is the genius of which there are three varieties: the inventive genius, the creative genius and the philosophic genius.<sup>1</sup>

This doctrine, too, is given religious significance.

Achievement comes to constitute a form of immortality and has an exceedingly attractive side. This hope of immortality has doubtless formed one of the important motives in all ages, but as the hope of personal immortality wanes under the glare of scientific truth, especially of biological truth, there is likely to be a still stronger tendency in this direction. Whatever other forms of immortality may be taught and believed in, the immortality of deeds is not an article of faith but a demonstrated fact. The real immortality is the immortality of achievement. And after all it is a personal immortality. Thus far it resembles Christian immortality in that only a few attain it. Only the elect are saved. They only are immortal who have achieved.<sup>2</sup>

Although this doctrine of the immortality of achievement will never satisfy those who anticipate conscious existence beyond the grave, nor does it offer hope to the toiling masses as does the Christian doctrine, it supplements the orthodox view in a most helpful way, and is a source of inspiration to the comparatively few leaders of social progress whose reward is not primarily from their contemporaries for whom they labor and give their lives, but whose reward comes in the consciousness that their labor is not in vain and that whether or not future generations connect their name with their achievement, humanity at large will enjoy greater well-being because they have lived. It has special significance, however, when applied to the social group.

To summarize the bearing of Ward's social philosophy on our subject: The process of cosmic evolution up to man is by *passive physical adaptation* interpreted largely in mechanical terms in much the same way as did Spencer whom he follows closely in many respects. Our author introduces psychical terms, however, even here, and considers with Schopenhauer that the world-soul with feeling as a dynamic has been pushing out blindly in every direction, the adaptive variations blazing the path of progress.<sup>3</sup>

<sup>1</sup> *Pure Sociology*, pp. 493 f.

<sup>2</sup> *Ibid.*, p. 43.

<sup>3</sup> *Ibid.*, chs. VI and VIII.

In the exposition of his theory as applied to social evolution he has made large use of principles elaborated by Gumplowicz, Ratzenhofer, Tarde and others with some modifications and additions. The process is almost entirely one of *passive spiritual adaptation* described by such terms as social assimilation, social karyokinesis (analogous to cross-breeding), compound assimilation and pacific assimilation, all working in accordance with the principle of synergy.<sup>1</sup> In this discussion natural selection is given a prominent place but reinterpreted and modified in view of psychical and social factors that enter into the higher phase of the cosmic process under consideration.<sup>2</sup>

His discussion of the dynamic factors of social progress forms a transition from passive to active adaptation. The first of these dynamic principles is "difference of potential," this term taken over from mechanics and illustrated by sexual reproduction in biology, being used by analogy to describe that phase of the social process which most sociologists today are explaining in terms of social suggestion and imitation. The second principle, "innovation" is interpreted also in terms of mechanics, following Tarde, but even more in terms of biology, having its biological analogue in the "sport," or fortuitous variation which our author considers to be the chief method in the origin of species.<sup>3</sup> The

<sup>1</sup> *Pure Sociology*, pp. 171 f.

<sup>2</sup> The prominence given to the doctrine of adaptation is seen by the following: "If the individual is at all adjusted to his environment his action will contribute in some degree either to the preservation or the continuation of life. At the lower animal stages . . . all desires are adapted to the needs of the creature and their satisfaction conduces to the life of either the individual or the species. Any continuous tendency to the contrary would result in the death of the former or the extinction of the latter. It is not really otherwise with society. We have fully shown how everything in society works for the conservation of the group and the race, and how the wayward tendencies of mankind have been subjected to natural and spontaneous restraints in the interest of social order. This social adaptation is well-nigh as complete as organic adaptation, and it would be impossible for any considerable number of men to persist in anti-social acts for any considerable time without disrupting society altogether. . . . Human desires are, therefore, more or less completely adjusted to individual and social needs, and it is safe to assume that the satisfaction of any normal desire also contributes in some degree to the preservation of the life of the individual or of other individuals . . . or to the maintenance of society, or both," *ibid.*, p. 250.

<sup>3</sup> *Ibid.*, pp. 240 f.

third principle is conation or social effort which, when directed to material ends, belongs to our division "active material adaptation" and results in achievement. Every dynamic action, he holds, has three effects: to satisfy desire, to preserve or continue life or to modify the surroundings. This last effort results largely from the projection of desire into the future, and is directly proportional to the distance between desire and its fulfillment. The effort put forth to attain this delayed satisfaction is the cause of the transformation of the environment, — a process summarized by the term achievement.<sup>1</sup> Active adaptation or anthropoteleology, or again, individual and social telesis come into prominence only among the most highly cultured men, with most people and groups the satisfaction of desire being the only conscious aim of endeavor.<sup>2</sup> In the analysis of conation two elements are emphasized, human desire and the instinct of workmanship the latter under normal conditions leading to the satisfaction of desire by work which is pleasure-giving.<sup>3</sup> As man always follows the line of least resistance or preponderant motives, and as the satisfaction of material wants is of primary importance for survival, there must be a surplus of wealth before the higher wants can be satisfied and a surplus always furnishes the conditions favorable for the development of cultural wants.<sup>4</sup>

In the discussion of individual and social telesis Professor Ward contributes to the fourth division of our subject, active spiritual adaptation, the former leading man to react on the mores of the group in the line of variation,<sup>5</sup> the latter making it possible for a group so to co-operate as not only to transform their material environment, but their spiritual environment as well in the interest of increased well-being.<sup>6</sup>

In his analysis of the function of the genius, Ward holds that here we have an illustration of the non-advantageous faculties of mind, though they are the outgrowth of those that are advantageous. The origin of the genius is not to be explained according

<sup>1</sup> *Pure Sociology*, pp. 248 f.

<sup>2</sup> *Ibid.*, pp. 465, 545, 555 f. Human invention, however, antedates history, *ibid.*, pp. 515 f.

<sup>3</sup> *Ibid.*, p. 245.

<sup>5</sup> *Ibid.*, p. 244.

<sup>4</sup> *Ibid.*, p. 59.

<sup>6</sup> *Ibid.*, ch. XX.

to the principle of natural selection, but rather to that of "spontaneous variation" issuing in a "sport." The aesthetic faculty is not considered to be primarily of adaptive value, but to minister to the satisfaction of individual feelings. Thus art in its manifold forms is not to be explained or justified according to the principle of adaptation but on that of egoistic satisfaction. Religion, though originally connected with the group sentiment of safety and so of adaptive value to the race, yet has differentiated into many forms, most of which are now probably somewhat disadvantageous.<sup>1</sup>

Finally, in his persistent emphasis on the potency of "nurture" as over against "nature," and on the necessity of social activity to preserve the "social germ plasm" by universal education, our author has contributed still further to this division of our subject. His *Applied Sociology* is a monument of painstaking work along this line and his general conclusions have been verified recently, to a considerable extent, as we have noted in previous chapters.

In scope, ripeness of scholarship, thoroughness of analysis and originality, Professor Ward's achievements in sociology remind us more than those of any other English writer in this field, of the characteristics attributed for the most part only to German scholars. These very qualities, however, have made his system almost inaccessible to the public, and difficult of reading even for students of the subject as their approach to social philosophy has not been through the natural sciences so much as through psychology, history, the social sciences and philosophy, — especially through economics and social psychology. Moreover his reasoning is largely deductive and analogical rather than inductive. He describes in terms of physics, chemistry, and biology rather than analyzes in terms of economics and psychology and this tends to prejudice the modern student.

The very comprehensiveness of his work together with the fact that much of it was done in times of sociological pioneering, has laid it open to criticism at many points:

1. His Lamarckian bias has made his biological interpretations unacceptable to those who, with the leading biologists of the

<sup>1</sup> *Pure Sociology*, ch. XVIII.

present, are more inclined to follow Weismann, De Vries and Mendel.

2. His materialistic monism<sup>1</sup> is opposed by those sociologists who prefer to follow such idealistic philosophers as Hegel or Kant, by the pragmatists who follow James, by the theists to whom the "personalism" of Bowne furnishes the most acceptable explanation of cosmic evolution, and especially by those who consider that sociology should be a science rather than a philosophy. A monist, yet supremely interested in emphasizing the place of purposeful activity in social progress, Ward is forced to face the dilemma of determinism and free will which he admits is a "fool's puzzle."<sup>2</sup> He grants the necessity of practical belief in free will but denies a place for it in philosophy. The difficulty here, as in all monism, is its endeavor to interpret life in terms of discursive thought.

3. Growing out of his monism and his preference for deductive reasoning, have arisen certain fallacies connected with his theory of the "dynamic agent" and with his analysis of "social forces."<sup>3</sup> Modern psychologists are calling our attention to the fact that there is no such thing as feeling in general, or thought or will. Experience gives specific feelings, ideas, volitions.<sup>4</sup> These may

<sup>1</sup> i. e., an endeavor to interpret cosmic evolution in terms of the redistribution of matter and force. This is shown in the following quotations:—

"No line between the properties of matter and physical forces. . . . It is now known that all matter is active, and the only difference between substances is the different ways in which they act. . . . Matter is causality," *Pure Sociology*, p. 19.

"All life has sprung from a homogeneous, undifferentiated plasm, which contained within itself the potency of all the varied forms that have evolved out of this plasm," *ibid.*, p. 85.

"This eternal pelting of atoms, this driving of the elements, this pressure at every point, this struggle of all created things, this universal nisus of nature, pushing into existence all material forms and storing itself up in them as properties, as life, as feeling, as thought, this is the hylozoism of the philosophers, the self-activity of Hegel, the will of Schopenhauer, the atom-soul of Haeckel: it is the soul of the universe, the spirit of nature, the 'First Cause' of both religion and science, — it is God," *ibid.*, p. 136.

<sup>2</sup> *Ibid.*, p. 21.

<sup>3</sup> Cf. "The 'Social Forces' Error," by Professor E. C. Hayes, *Publications of American Sociological Society*, vol. v.

<sup>4</sup> Especially Thorndike, *The Original Nature of Man*.

be classified for logical purposes, but Professor Ward seems to identify the product of logical classification with ontological reality.

4. Approaching social philosophy from the point of view of biology and individual psychology, and an individualist much like Spencer, his philosophy culminates in an emphasis on pleasure and consumption which on the whole seems to be its weakest point. Although in *Pure Sociology* abundance of life is set forth as the apparent end of cosmic evolution,<sup>1</sup> in *Dynamic Sociology*, pleasure is given a place of pre-eminence, this being correlated with increase in the complexity of organisms.<sup>2</sup> This emphasis, however, does not grow out of his system necessarily, indeed seems almost to have been grafted on. If abundant life is the end; if adaptation is the means to abundant life, as he holds, and if pleasure and pain are sign-boards indicating the ways of life and death,<sup>3</sup> as he shows also, the end of telic endeavor should be adaptation, not pleasure; and the test of progress should likewise be adaptation and abundance of life, — an objective test which Spencer insisted rightly was necessary for science. This error, if it be one, is the result of his thesis that feeling is the dynamic agent in social progress. [Desire, with him, is the mainspring of human endeavor.<sup>4</sup> Modern functional psychology, on the contrary, makes organic reactions the fundamental phenomena, sensations of pleasure and pain being considered as arising in connection with these reactions because of their adaptive value. The organic needs that impel to activity may well be termed "interests" as with Ratzenhofer.

<sup>1</sup> *Pure Sociology*, p. 114; cf. p. 1.

<sup>2</sup> *Dynamic Sociology*, ii, pp. 173 f. Cf. *Pure Sociology*, p. 126, where feeling is considered as an end.

<sup>3</sup> *Pure Sociology*, p. 130.

<sup>4</sup> "Preservation, continuation, and augmentation are the three aspects of the cosmic end. . . . But it merely *happened* that at a certain point it became necessary, in order to secure these ends . . . to furnish . . . later creations with some form of *interest* that should enable them to assist in the prosecution of the plan. Hitherto the products of creative synthesis had been passive. Henceforth they were to become active. . . . The form which this interest took was the faculty of feeling, whereby these tocogenetic creations were made to care for themselves. . . . Henceforth there was to be *animated nature*. . . . In it [feeling] were contained the psychic world and the moral world. With it came pleasure and pain



5. Ward's teaching that all the stress should be placed on material achievement — the outcome of his monism, deductive method and hedonism — is open to question. The cycle of national growth and decay as illustrated in history, as has been pointed out by many sociologists, shows that *emphasis on production of material goods for the sake of consumption results in national degeneration*. If now we take the group instead of the individual as the sociological unit, we are warranted in saying that stress on material achievement when linked with hedonism furnishes the most destructive kind of a social philosophy so far as the welfare of the social group is concerned.

6. Closely linked with the above criticism is that of his interpretation of the function of art and religion. These are the product of sociological "sports" according to our author, as noted above, and not to be evaluated because of their influence on the life and success of a group. Indeed they are now, for the most part, of no adaptive value, if not positively disuseful except as they satisfy individual desire. The genius who is the innovator hence the source of those variations which make for social progress is likewise a "sport." Religion in the beginning was of adaptive value, according to Ward, else it could not have gotten a start, and this value was due to its relation to the "group sentiment of safety." This sentiment, however, is considered to play an ever decreasing part in social evolution; patriotism is discounted,<sup>1</sup> and the decay of a group or nation considered of little moment. Individual pleasure and the process of civilization are the "be all" and "end all" of telic activity and, with apparently little appreciation of the potency of group self-consciousness and loyalty as factors in increasing social and so individual well-being, such concepts as social innovation, social suggestion and social imitation are given almost no consideration.<sup>2</sup> With more recent emphasis on the species as the biological unit, and a social with all their momentous import, and out of it ultimately grew thought and intelligence. Nature cared nothing for any of these. They were unnecessary to her general scheme, and not at all ends of being. Mind was therefore an accident, an incidental consequence of other necessities,—an *epiphenomenon*," *Pure Sociology*, pp. 127, 128.

<sup>1</sup> *Ibid.*, pp. 211 f.

<sup>2</sup> Cf., however, *ibid.*, pp. 568 f.

group of some sort as the sociological analogue, — especially the state; with the present teaching, also, which distinguishes the mere “sport” from the mutation that has adaptive value for the species, the real genius in human society and his products, in so far as they foster idealism, lead to group unity, and stimulate to productive endeavor, are of the very greatest utility to the group.

Finally, in his failure to give due consideration to social psychology with its concepts of group consciousness and the expanding self-regarding sentiment, he has left untouched one of the most potent dynamics in social cohesion and social telesis.

The social philosophy under review, however, with emphasis on material achievement, on the power of intelligent volition and on the value of that education which makes for control over the forces of nature, has been so well adapted to the “age-spirit” of all western nations during the past fifty years that it has exerted a profound and lasting influence on sociological thought throughout the world. More recent advance in biology, inductive social science and especially psychology, tend to discredit some of Ward’s conclusions, yet he will ever rank as one of the foremost of American sociologists and as one who has contributed most of any, perhaps in the world, to the development of the doctrine of *active material adaptation*.

SIMON N. PATTEN (1852— )

*Pain-Pleasure-Creative Economy*

In the writings of Professor Patten we have a forceful example of the statement made in the Introduction that the historical tendency in social philosophy from Comte and Spencer to the present has been in the line of increasing emphasis on active as against passive adaptation. In Professor Patten’s earlier writings, even in his *Theory of Social Forces*, the latter point of view is dominant, whereas in his latest, *The Reconstruction of Economic Theory*, his former position is criticized and corrected in the light of changes that he admits have come into his own views in the line of greater emphasis on creative activity.<sup>1</sup>

<sup>1</sup> Cf. Seager’s criticism, “Professor Patten’s Theory of Prosperity,” *Annals, American Academy Social and Political Science*, March, 1902.

An apparent strain after the novel characterizes all his writings, and in the earlier, especially, deductive rather than inductive reasoning. That he has given the world hastily-formed hypotheses unsupported by scientific investigation is indicated by the fact that he has had but few followers, though many admirers, and that he has so frequently shifted his position and negated former conclusions. Such a writer is frequently suggestive but rarely convincing.<sup>1</sup>

One doctrine formulated by him, however, seems to have found an enduring place in social philosophy which will be strengthened, I believe, in the light of his recent corrections, — his theory of the contrast between a pain and a pleasure economy, or progress as the result of a surplus rather than a deficit economy.

This doctrine rests upon certain biological and psychological postulates which must be sketched briefly: —

1. Biological evolution is neither the result of chance variations of adaptive value, preserved by natural selection as with the neo-Darwinians, nor the result of the inheritance of acquired tendencies or characters as with the neo-Lamarckians but is due to the acquirement of surplus energy or variations resulting from such surplus which lead to change in environment and this, in turn, to permanent modifications.<sup>2</sup>

Invading the domain of cytology to get a basis for his psychological approach, he makes the following assumptions: (1) that consciousness and movement are opposite poles of the same forces and that both are present in the beginning of cell growth; (2) that the original germ cell has a capacity for consciousness but no content until a structure is developed through which will and memory are evolved; (3) that growth creates folds and they become incipient ovaries, the sex-products of which are nerve cells which become differentiated until finally sensation, memory, and consciousness are eventually evolved by the process of selection.<sup>3</sup>

<sup>1</sup> Cf. Ward's appreciation, *Pure Sociology*, p. 105.

<sup>2</sup> *Heredity and Social Progress*, pp. 28 f., 63; *Theory of Social Forces*, pp. 14 f., 50 f.; *Theory of Prosperity*, pp. 20, 159 f., 196.

<sup>3</sup> *Heredity and Social Progress*, pp. 76, 89, 90. These hypotheses have no inductive support.

Advancing from cytology to physiology, Patten argues analogically back from sociology, endeavoring to explain the association of cells in the mind by the conscious association of men in society.<sup>1</sup> This is novel and suggestive if not convincing. All improvement in mental power, he holds, is due to improvement in mental mechanism, i. e., in the mechanical arrangement of the constituent elements<sup>2</sup> and this improvement comes on the one hand from surplus energy secured in a favorable environment which expends itself in motor activity resulting in the development of the motor feelings of pleasure and pain, and in growth; and, on the other hand, as a result of forced migration to escape competition, which results in the development of new organs and sensory feelings.<sup>3</sup>

“There are thus,” he says, “two stages of progress, — the biologic and the social, — corresponding to the two possible environments. In the biologic stage beings are pushed into a local environment where the objective conditions are so complete that little thought is needed to supply the necessities of life. Under these conditions the development of the motor powers determines who shall survive. The organism becomes a more nearly perfect individual because of the growth of organs on the one hand and an increase of desire on the other. In the struggle for such an environment the beings with the superior motor powers drive out those with inferior motor powers. Some of the latter class are, however, better fitted to occupy a general environment where their sensory powers are of more use than in the local environment from which they were driven. The conquered thus find a place to live and by the development of some of the social forces create for themselves a new society with new requisites for survival. When the struggle for existence begins within this new environment, those with superior motor powers will again survive, while those with an imperfect motor organization, but with improved sensory powers, will be forced again into a more general environment where new social instincts must be acquired.”<sup>4</sup> This last quotation takes our author into the domain of psychol-

<sup>1</sup> *Theory of Social Forces*, pp. 18 f.

<sup>2</sup> *Ibid.*, pp. 19 f.

<sup>3</sup> *Ibid.*, pp. 48, 51.

<sup>4</sup> *Ibid.*, p. 52.

ogy which is very important in his social philosophy, especially the theory of psycho-physical parallelism in so far as it asserts that energy derived from metabolism must find expression in some other form of activity, — muscular, intellectual or emotional, — which theory is the basis of his doctrine of surplus energy.<sup>1</sup>

The development of social forces according to Patten is not due entirely to an objective environment to which the organism must adapt itself, perish, or move to a new environment, but to a subjective environment made up of forms of thought and ideals,<sup>2</sup> which crystallize into knowledge and belief,<sup>3</sup> and ultimately find expression in customs, habits, social institutions and race ideals.<sup>4</sup>

The change from one environment to another, demanding a change in habits, beliefs and ideals, is fraught with great danger.<sup>5</sup>

Extension of knowledge comes through organic reactions first to sense of touch, then to vibrations in the surrounding medium through sensations of light, sound and smell. Fear is the first sensation which a perception of these vibrations creates, — and fear is usually connected with moving objects. The recognition of the world as an aggregate of materials shifts the interest from pains to pleasures, with a corresponding increase of knowledge.<sup>6</sup> Soon the distinction is drawn between the natural and the supernatural, — the former connected with pleasure, the latter with pain. "The growth of knowledge is not due to developed men coming in contact with more of nature. It is due to beings of limited sensory powers gradually increasing their powers as they are forced to know nature more intimately or to come in contact with larger areas of the world. Each new requisite for survival has caused the development of some new sensory power, and has thus created an area of knowledge independent of the older areas, and in no logical connection with them. Knowledge comes by leaps and bounds when a new environment with new requisites for survival is entered."<sup>7</sup>

<sup>1</sup> *Theory of Social Forces*, pp. 26 f., 64; *Heredity and Social Progress*, chs. XI, XVI; *Theory of Prosperity*, ch. XI; *Annals, American Academy Political and Social Science* (1897) p. 34.

<sup>2</sup> *Theory of Social Forces*, p. 54.

<sup>3</sup> *Ibid.*, pp. 49 ff.

<sup>4</sup> *Ibid.*, pp. 53, 119.

<sup>5</sup> *Ibid.*, p. 56, ch. IV.

<sup>6</sup> *Ibid.*, p. 60.

<sup>7</sup> *Ibid.*, p. 63.

This leads our author to discuss the distinction between a pain and a pleasure economy, the former based on necessity of struggle for existence carried on under the dominating impulse of fear, the latter based on life lived under conditions favorable to survival, relatively free from competition, resulting in abundance of surplus energy which manifests itself in motor activity, accompanied by the motor sensation of pleasure.

Under the former economy human institutions have as their basis the fear of enemies and pain,<sup>1</sup> causes lying in the environment. But "the development of human society has gradually eliminated from the environment the sources of pain. The civilized world has been freed from dangerous beasts and reptiles, and the growth of large nations has cut off the danger of invasion by barbarous and warlike human foes. . . . The sensory powers have free play in analyzing this material into its elements, and in reorganizing these elements into valuable goods. These changes make a pleasure economy possible and destroy the conditions which make the subjective environment of the old pain economy a necessity."<sup>2</sup> This transition is perilous and has caused the downfall of many nations owing to their inability to make a readjustment.

The human race is now, he holds, in a state of transition from a pain to a pleasure economy.<sup>3</sup> Under an ideal pleasure economy "there would be two prominent groups of motives, — the one prompting actions which increase the pleasure of the individual, and the other prompting actions which promote the progress of the race. . . . Each tendency to get pleasure at the expense of social welfare would be counteracted by the formation of some ideal or social institution with which would be coupled impulses prompting to their realization. The requisites for survival would be those social impulses which preserve individuals from temptation, disease and crime. The number of ideals and institutions would be gradually increased until their united effect would be strong enough to determine the choices of individuals and make their conduct conform to the interests of the race."<sup>4</sup>

<sup>1</sup> *Theory of Social Forces*, p. 75.

<sup>2</sup> *Ibid.*, p. 76.

<sup>3</sup> *Ibid.*, p. 80.

<sup>4</sup> *Ibid.*, p. 84.

In the ideal commonwealth under a pleasure economy there must be the elimination of all such rivalries and conflicts as produce fear.<sup>1</sup> In such a commonwealth "the economic forces would constitute the first and elementary bonds uniting the members of such a society," leading to division of labor, the storing of energy in the form of capital, and, as a result of differences in soil, climate, and universal products, to commerce. Self-interest would call for co-operation and organization. The conditions of consumption as well as of production would assist in uniting men.<sup>2</sup>

Increase in standard of living with variety in diet results in greater social interdependence as well as in increased individual well-being.<sup>3</sup> Increasing range of desires and the demand for harmonious groups of utilities are potent factors in the formation of social organizations.<sup>4</sup> "The economic forces, therefore, are sufficient to create powerful bonds uniting the individuals into a social commonwealth even if they feel no other motives than those due to the pursuit of pleasure."<sup>5</sup> "The race ideals are an outgrowth of the same process through which harmonious groups in consumption are formed."<sup>6</sup> The aesthetic ideals are the first to be formed, then the moral and finally the religious.<sup>7</sup>

Thus according to our author, up to the present man has been dominated largely by fear and pain due to lack of adjustment with his environment and this failure, in turn, has been due primarily to lack of productive power. With increased power over his environment (active material adaptation) there results normally a surplus of energy, motor activity and pleasure, the process of industrial evolution leading to ever increasing social bonds and institutions, these being supplemented by associations arising out of consumption. The greatest danger in this process arises from the tendency to expend this surplus energy in wasteful consumption, i. e., consumption not resulting in health, growth, and in those forms of activity that increase individual and social well-being. Such wasteful consumption is dissipation leading to degeneration and elimination by the law of selection.<sup>8</sup> The con-

<sup>1</sup> *Theory of Social Forces*, p. 83.

<sup>2</sup> *Ibid.*, pp. 85 f.

<sup>3</sup> *Ibid.*, pp. 86 f.

<sup>4</sup> *Ibid.*, p. 89.

<sup>5</sup> *Ibid.*, p. 90.

<sup>6</sup> *Ibid.*, p. 91.

<sup>7</sup> *Ibid.*, p. 94.

<sup>8</sup> *Theory of Prosperity*, pp. 166 f., 180.

trast between a pain and a pleasure economy is reflected also in religion, the former being linked with a religion of fear, sacrifice, etc., the latter with a religion of love, worship and service.

Professor Patten finds that the classical economists, in fact nearly all up to the present, have built theories on a pain or deficit economy and he pleads now for a reconstruction of economic theory based on a pleasure or surplus economy. He holds, also, that the practical problems of social science can be solved only by increasing the surplus of the mass of wage earners and by guiding them in wise consumption. The surplus in the case of the rich should be drawn off in social service.<sup>1</sup>

Passive adaptation, both material and spiritual, finds large place in Patten's social philosophy especially in his early writings. Nearly all of his *Theory of Social Forces* and *Heredity and Social Progress* is from this point of view, so, too, much of his *Theory of Prosperity*. The key-note of *The New Basis of Civilization* and *Reconstruction of Economic Theory*, however, is active adaptation. The resources of nature under man's control should provide for all his increasing needs.<sup>2</sup> Surplus and leisure for the lower classes will lead to culture and efficiency<sup>3</sup> and tend to break down social classes and distinctions.<sup>4</sup> Reflective morality, idealization, and religion are needed to inspire to productivity, self-control, efficient consumption, and social service, and social control has a most important function in bringing about such an industrial and social reorganization as shall make widespread the surplus that tends to issue in growth, variation, pleasure, idealization and progress.<sup>5</sup>

The law of rhythm as manifested in the phenomenon of growth and decay in nations is not necessary according to our author, but it can be prevented from operating only on the condition that consumption is controlled with reference to future efficiency. "The normal man seeks to establish a direct relation between his consumption and production, and forms of consumption that do not result in the creation of surplus energy are dissipation and hinder him in his struggle for existence and superiority. The

<sup>1</sup> *Theory of Prosperity*, p. 168.

<sup>2</sup> *The New Basis of Civilization*, ch. I.

<sup>3</sup> *Ibid.*, pp. 63, 156, 160 f.

<sup>4</sup> *Ibid.*, ch. IV.

<sup>5</sup> *Ibid.*, ch. VIII.



dissipated are thus steadily eliminated, leaving those whose use of goods tends to create surplus energy. Every increase of productive power adds to the quantity of goods consumed, and these if properly used augment the surplus energy of workers."<sup>1</sup>

Nowhere is his recent emphasis on active adaptation so clearly revealed as in his criticism of his own theory of "pleasure-pain" economies. "I now regard this division as defective," he says. "To love pleasure is a higher manifestation of life than to fear pain; but the pleasure of action is in advance of the pleasure of consumption. Action creates what pleasure uses up. This would divide progress into three stages: a pain economy, a pleasure economy and a creative economy. Each stage has its own mode of thought, and its own social institutions." His new complete theory is thus visualized.<sup>2</sup>

Stage of Progress	Form of Struggle	Form of Control	Character of the Social Bond
1. A pain economy	Race struggle	Ancestral control	Blood bonds
2. A pleasure economy	Class struggle	Wealth control	Interest bonds
3. A creative economy	Self-direction	Character control	Social beliefs

Type of Thought	Thought Limitations	Kind of Philosophy	Type of Morality
1. Theological	Substance	Anthropomorphic	Traditional
2. Rational	Space	Material	Utilitarian
3. Pragmatic	Time	Ideal	Telic

The importance of the active factor in securing adjustment is revealed in his list of checks to expenditure which tend to bring the family budget to an equilibrium.<sup>3</sup> His conclusion is of interest for it is his last word to date in his social philosophy. "Surplus promotes activity and that activity transforms the natural surplus into wealth. With wealth come price relations through which ancestral control is broken and wealth control put in its place. Price relations give rise to budgetary concepts. In the endeavor to bring the family budget to an equilibrium, activity is increased and consumption is put on a cultural basis by increasing the intensity of new wants. This brings on a self-repression which is the essence of character building. The

<sup>1</sup> *Theory of Prosperity*, p. 15; Seager, *op. cit.*, p. 83.

<sup>2</sup> "Reconstruction of Economic Theory," *Annals, American Academy Political and Social Science*, 1912, (Supplement), p. 92.

<sup>3</sup> *Ibid.*, p. 62.

struggle for supremacy is now changed from a race and class struggle to an internal struggle for self-control. Primitive feelings and instincts are repressed, sex and appetite are curbed, and cultural motives replace the older sentiments due to race and class antagonisms. . . . The new and the old types of culture, motive and character are bound to come into sharper conflict as the century advances. The older tendencies are coercive and will strive to impress themselves as state socialism. The newer forces will express themselves in voluntary association. It will be a struggle of tradition, race and class with the blending influences that make for unity and character.”<sup>1</sup>

Professor Patten is his own best critic of many of his early theories. If time and intellectual vigor permit he may round out a consistent social philosophy. His greatest advance has come from his transition from an almost exclusively deductive method to emphasis on, though not successful use of, the inductive method, and from stress on pleasure-pain motives and tests, to objective tests measured in terms of health, wealth and culture.<sup>2</sup>

His theory that progress is due to surplus energy and that historically social progress has passed from a pain to a pleasure economy and is now entering a creative economy, is so suggestive that it is most unfortunate that he has developed the theory in such a way as to meet disapproval from the specialists in every field he has touched.

<sup>1</sup> “Reconstruction of Economic Theory,” pp. 94, 95.

<sup>2</sup> *Ibid.*, p. 91: cf. pp. 61, 86, 87.

## CHAPTER XIII

### INVENTION AND PRODUCTION (CONTINUED)

THOMAS N. CARVER (1865- )

#### *The Super-Group*

WITH Professor Carver the chief function of sociology is to work out a consistent and thorough-going theory of social progress and its only justification is social amelioration.<sup>1</sup> It is thus a social philosophy. To the methods of sociological investigation outlined by Comte he adds a fifth, viz., the study of social forces now at work, and holds that instead of interpreting present events solely in the light of historical analyses the more effective method is to interpret both the present and the past by an analysis of forces now at work.

Two preliminary assumptions are made: first, that this is a rational universe, — a cosmos rather than a chaos; and second, that life is a good thing; i. e., that life is better than death. If life is a good thing, then more life is a better thing. He goes a step further in *The Religion Worth Having*, and assumes that this is God's world and that the laws of the universe are God's laws. From a religious point of view it is necessary to be obedient to the will of God, but this calls for an understanding of that will as revealed in the cosmic process.

Professor Carver does not stop with mere abundance of life as the goal of the cosmic process, but emphasizes quality; as a neo-Darwinian, however, he believes that quality can be secured only by a process analogous to that which prevails in biological evolution, i. e., superabundance of life, variations, struggle for existence, elimination of the ill-adapted and inheritance of adaptive qualities, a process leading gradually to the production of new and higher species, — higher, that is, because better adapted to life conditions. As the cosmic process, according to

<sup>1</sup> *Sociology and Social Progress*, Introduction.

his view, has issued in man who is not merely the product of passive adaptation, but who is able to react on that process and guide it within certain limits in the interest of increased well-being, his cosmology is anthropocentric, or better, perhaps, socio-centric, for while recognizing that the individual has a metaphysical reality such as cannot be posited of any other creature or of society, yet with him the sovereign group is the sociological unit and its success necessary to the well-being of the individuals that constitute the group.

His strong neo-Darwinism is indicated by the choice of selections in his *Sociology and Social Progress* and shown conclusively in *The Religion Worth Having*<sup>1</sup> and *Essays in Social Justice*<sup>2</sup> in which the biological doctrine of struggle and survival is applied rigidly to human life and progress with emphasis, however, on the struggle between sovereign groups.

The key to Professor Carver's social philosophy as suggested in our Introduction is the doctrine of adaptation, as set forth in the following scheme:<sup>3</sup> —

Kind of Adaptation	ENVIRONMENT	
	Material	Social
Passive	{ Biological Evolution	Moral development Education
Active	{ Industrial Progress	Social Control

Professor Carver follows Weismann closely in his interpretation of the doctrine of selection, holding that the ill-adapted are eliminated only "by-and-large and in the long run," and that the struggle is chiefly between species. He believes with all biological sociologists that the highest human powers and faculties and institutions have been evolved by an analogous process.

In social development the group corresponds to the biological species and although the primordial struggle for existence prevailed among primitive groups this has been supplanted by a struggle between nations for the markets of the world. Within the group there is struggle for wealth, place, power, etc., and this

<sup>1</sup> *The Religion Worth Having*, pp. 20 f., 42-45, 88 ff.

<sup>2</sup> *Essays in Social Justice*, ch. I.

<sup>3</sup> Class lectures; cf. *Sociology and Social Progress*, pp. 9, 10.

has gone through three distinct stages: "The first stage is struggle by destruction, that is private war; the second is struggle by palaver, that is politics; the third is struggle by production, that is economic competition."<sup>1</sup>

Struggle for existence, according to our author, indicates scarcity, for if all wants were satisfied there would be no scarcity. Scarcity is thus relative.<sup>2</sup> Its cause is attributed to the niggardliness of nature, for the commodities that nature has supplied in such abundance as to satisfy all man's wants have no economic value. "The fact that there are human wants for whose satisfaction nature does not provide in sufficient abundance, in other words, the fact of scarcity signifies that man is, to that extent at least, out of harmony with nature." This makes labor and fatigue necessary which are, therefore, signs of mal-adaptation.<sup>3</sup> "That there is a deeper harmony hidden somewhere beneath these glaring disharmonies is quite possible," — but this problem is passed over to philosophy. The whole evolutionary process, he holds, both passive and active, both biological and economic, is a development away from less toward greater adaptation, from less toward greater harmony between the species and its environment.

Economic scarcity, according to our author, is the chief cause of the disharmony between man and man, and in the conflict of interests thus resulting we have the origin of the problem of evil.<sup>4</sup> "Fundamentally," we are told, "there are only two practical problems imposed upon us. The one is industrial and the other moral; the one has to do with the improvement of the relations between man and nature, and the other with the relations between man and man."<sup>5</sup>

As to the cause of economic scarcity, it is due primarily to the indefinite expansion of human wants, and to the multiplication of numbers, and for both man is in a large measure responsible. "It would be difficult to find any question in the whole science of jurisprudence, or of ethics, or politics, or any of the social sciences for that matter," says our author, "which does not grow out of

<sup>1</sup> *The Religion Worth Having*, p. 55.

<sup>2</sup> *Essays in Social Justice*, ch. II.

<sup>3</sup> *Ibid.*, pp. 38, 40.

<sup>4</sup> *Ibid.*, pp. 41 f.

<sup>5</sup> *Ibid.*, p. 43.

the initial fact of economic scarcity and the consequent antagonism of interests among men. This reveals, as nothing else can, the underlying unity of all the social sciences . . . and it shows very clearly that the unifying principle is an economic one."<sup>1</sup>

Passing to a consideration of methods of escape from the difficulties imposed upon us by economic scarcity, the simple life is found insufficient if linked with uncontrolled passion, and insufficient, too, and for the same reason, industrialism, due to the fact pointed out by Malthus that population tends to increase faster than the means of subsistence.

Only one way of escape seems open. "Even under the conditions of economic scarcity there would be no antagonism of interests between man and man if human nature were to undergo a change by which altruism were to replace egoism."<sup>2</sup>

As a practical working program of meliorism our author suggests: (1) improvement in methods of production; (2) simpler life, especially on the part of the wealthier class; (3) an increasing sense of the responsibilities of parenthood, especially among those classes who can least afford to spawn; and (4) a more widespread spirit of altruism. "In spite of all these methods, however, there will still be antagonistic interests to be adjudicated. The state must therefore continue to administer justice."<sup>3</sup>

This doctrine of economic scarcity is closely connected with the laws of diminishing returns and proportionality, which Professor Carver has elaborated as has no other economist.<sup>4</sup>

These laws have profound bearing on all labor problems, for they are due, fundamentally, to the fact that there are too many unskilled laborers in proportion to the amount of land, capital and organizing ability involved. If capitalists are getting too large reward, says Professor Carver, it is because they are too few in proportion to the other factors in production. One way, then, to increase the wages of the lowest economic class is to increase the number of capitalists. Another way is to decrease the number of unskilled laborers. The reason wages are higher in one occupa-

<sup>1</sup> *Essays in Social Justice*, p. 50.

<sup>2</sup> *Ibid.*, p. 51.

<sup>3</sup> *Ibid.*, pp. 52, 53.

<sup>4</sup> *Distribution of Wealth*, chs. II and IV. Cf. Marshall's *Principles of Economics* (1910), p. 169; also *Efficiency Society Transactions*, i, no. 63.

tion than in another is due to a relative disproportion of numbers in the two occupations. The reason prices of food are high in one place and low in another is due primarily to the operation of the same law. In the solution of the labor problem we may be sure that there are not too many capitalists for their return in interest is great; that there are not too many captains of industry for their income is enormous; that there is not too much land, for rent is ever increasing; that there are not too many skilled mechanics, for their wages are high. We may be sure, however, that there are too many unskilled laborers, for their wages are low.<sup>1</sup>

A third economic law is given almost equal prominence with these two and that is the law of productivity as a measure of value. And here, again, Professor Carver has gone far beyond any other economist, for he has elaborated Ricardo's productivity theory of land value and rent, and the modern productivity theory of wages and applied it as a measure of man's value to society. Just as the value of any piece of land can be determined by what it adds to the total productivity of the community, and just as a man's wages are determined by what he adds to the total productivity of the concern for which he works, so a man's value to society may be measured, theoretically, by the increase of economic goods produced as a result of his contribution, — and this holds not merely of the manual laborer but of the teacher, preacher, and artist.<sup>2</sup> That is, education, art, morals and religion are not ends in themselves, nor is their end individual enjoyment or perfection. The social unit is the group, and intergroup competition makes group strength the criterion of the good. Inasmuch as production of wealth is the *sine qua non* of group strength, education, art, morals and religion are to be evaluated in proportion as they increase the productive and competitive power of the group. Just in proportion as society rightly appreciates the utilities needed for group strength, and in harmony with the law of supply and demand, will wages measure man's value to society.

<sup>1</sup> Adapted from Professor Carver's lectures; cf. *Essays in Social Justice*, ch. XIV.

<sup>2</sup> Cf. *Distribution of Wealth*, chs. I and IV; "Diminishing Returns and Value," *Rivista di Scienza*, iv, pp. 12-14; *Essays in Social Justice*, ch. VII.

This law of man's value to society is expressed by means of the following formulae:—

“The value of a man is equal to his production minus his consumption. His economic success is equal to his acquisition [i. e., his income] minus his consumption. When his acquisition is equal to his production [i. e., when a man receives as income the equivalent of what he has added to the total productivity of the group of which he forms a working part], then his economic success is equal to his value.”<sup>1</sup> This puts a premium on merit and strengthens the group in competition with other groups. The function of the state, then, is to see to it that a man receives as income what he produces, or in other words, to prevent the miscarriage of the law of productivity applied to wages. “That is justice.”<sup>1</sup>

Civilization is interpreted by Professor Carver largely in terms of productivity as it is also by Dr. Ward. “Civilization,” he says, “is essentially a storing of surplus energy, and is due to the fact that men have had more energy to expend than was necessary to procure subsistence.”<sup>2</sup> The beginning of this process, so far as the group is concerned, is considered to be due to the rise of a despot, but “slavery, religious fear, aristocracy, — these have all doubtless been agencies for the accomplishment of the same purpose.”<sup>3</sup>

Private property as reward for efficiency, and pride in family building closely linked with it, are considered to be of primary importance. Indeed the two are inseparably connected, in the thought of our author, both historically and logically. Our present industrial system places the responsibility for the rearing of children upon the one who is responsible for their coming into the world, and this is the best check yet evolved or devised for limiting population to means of subsistence according to the prevailing standard of living. Remove this check and population would increase so rapidly as to entail wide-spread misery, leaving only the natural checks of war, pestilence and famine, and

<sup>1</sup> *Essays in Social Justice*, p. 173.

<sup>2</sup> *Sociology and Social Progress*, p. 13.

<sup>3</sup> *Ibid.*, p. 13; *Essays in Social Justice*, p. 134.



artificial checks imposed by social control. The monogamic family has no other justification than this, — the regulation of the increase of population in the interest of social efficiency. Abolish private property and the logic of the situation, as many socialists assert, makes probable the disintegration of the domestic institution. But with private property, family pride is a great incentive to the production of wealth.<sup>1</sup>

As the utilization of every possible motive is necessary to secure maximum productivity, all socialistic schemes that look to the abolition of private property or of competition and economic reward, are considered disastrous.

In his introduction to *Sociology and Social Progress* emphasis is given to the power of idealization as one of the important psychic factors in the development of civilization. "This may be defined not very inaccurately as the power of *making believe*, — a factor which sociologists have scarcely appreciated as yet. . . . One of the greatest resources of the human mind is its ability to persuade itself that what is necessary is noble, or dignified, or honorable, or pleasant." The idealization of war in the military stage of civilization, and the idealization of work in more recent times are given as illustrations. "Work is still a necessity as imperious as war ever was. Looked at frankly and truthfully work is a disagreeable necessity and not a good in itself. Yet by persuading ourselves that work is a blessing, that it is dignified and honorable, our willingness to work is materially increased, and therefore the process of adaptation is facilitated; in other words, progress is accelerated. For this reason, he who in any age helps to idealize those factors and forces upon which the progress of his age depends, is perhaps the most useful man, the most powerful agent, in the promotion of human well-being, even though from the strictly realistic point of view he only succeeds in making things appear other than they really are. From the

<sup>1</sup> Class lectures; cf. *Principles of Rural Economics*, p. 337. Professor Carver seems to have overlooked the function of the monogamic family in the process of social adaptation. The children, closely resembling the parents, are easily assimilated to the customs of the family group and by this means to those of the larger social group; moreover the monogamic family has great possibilities in training for social efficiency.

sociological point of view this is the mission of art and preaching of all kinds." <sup>1</sup>

Desire for social esteem is a fourth motive for productivity and functions advantageously in proportion as society appreciates and rewards the producer.<sup>2</sup> The dollar yard-stick so frequently anathematized today by moralists, is after all an effective means of securing the surplus so necessary for social good.

Patriotism, when properly conceived, is a most potent force. Every one who is interested in the success of the group must be interested in doing that which will insure success. The highest form of patriotism is not that which is awakened merely when the nation faces a crisis, but the form that responds daily to the nation's daily need. True patriotism calls for a willing subordination of individual to group welfare; and as the multiplication of numbers and production of economic goods, or in other words, the increase and economizing of human energy, are of prime importance, patriotism calls for the subordination of consumption to production. Pleasure cannot be an end in itself according to this philosophy, but on the one hand the sign board of health and efficiency, and on the other, the means of securing increased production.

Finally, and in some respects most important of all, is religion. Religion is defined as "such belief in or regard for supernatural agents as to influence conduct." The only religion worth having is the one which so energizes life as to make it most productive, and the best religion is the one which is the most energizing. "That is the best religion which (1) acts most powerfully as a spur to energy, and (2) directs that energy most productively."<sup>3</sup> In discussing this he makes use of the biological formula and concludes: "The religion worth having is the religion which brings the largest success in the final and ultimate sense to the peoples and nations which adopt it and enables them to survive in competition with peoples and nations possessing any other type of religion. . . . The religion which enervates or subdues the

<sup>1</sup> Cf. Comte, *Positive Philosophy*, ii, p. 315; *A General View*, ch. VI.

<sup>2</sup> Cf. *The Religion Worth Having*, pp. 65 f.

<sup>3</sup> *Ibid.*, p. 13.

spirit of a people, which does not develop their latent energy, or which wastes their energy in a kind of effort which does not support life or support it abundantly, will fail because it will cause the failure of the people who are handicapped by it. But the religion which stimulates to high endeavor and develops the latent energy of its people, and directs that energy wisely and productively, will succeed because the people who are fortunate enough to possess it will succeed and hold dominion over the world.”<sup>1</sup>

The third general division of Professor Carver's social philosophy is passive social adaptation which includes moral development and education. As already indicated the welfare of the sovereign group is the *summum bonum* and the standard for judging all other good. In this discussion we are reminded of both Nietzsche and Spencer. He differs from the former in substituting the concept of the super-group for that of the super-man thus making large place for sympathy, sociability, co-operation and religion, negatived by Nietzsche. He differs from Spencer chiefly in the following points:—

1. Adaptation rather than increasing complexity is considered the test of progress with no expectation of attaining a state of perfect equilibrium.

2. Spencer's negative regulative theory of government is replaced by a strong doctrine of social control.

3. The well-being of the group is placed above that of the individuals that compose it. Spencer held this position for the group when endangered by another group but thought this menace would decrease continually under industrialism. Professor Carver sees no possibility of removing the causes of inter-group conflict because of the working of the Malthusian law of population and the law of diminishing returns.<sup>2</sup>

With Professor Carver, then, that is good which tends to strengthen the group in competition with other groups. That is evil which tends to weaken the group. As his social theory is a

<sup>1</sup> *The Religion Worth Having*, pp. 22, 23.

<sup>2</sup> In this he agrees with Van Dyke Robinson. See *Selections*, p. 133. Cf. *Essays in Social Justice*, chs. I and II.

synthesis of biological "adaptation" and economic "productivity" so his ethical theory is a synthesis of intuitionism and evolutionary utilitarianism. We have intuitions of right and wrong, but these are not absolute. Our moral intuitions are our personal interpretations of the mores of the group to which we belong. These mores are the result of social evolution and social utility. We first passively adapt ourselves to them, then in some small degree react on them in the line of variation, and in a few cases men have gotten a deeper insight into social values and become prophets or moral reformers.<sup>1</sup>

The moral is the socially useful. The one who acts contrary to the mores of the group is adjudged immoral. The one who acts contrary to these mores or conventions that have become crystallized into law is adjudged a criminal. Motive does not count except as it determines conduct.

As the moral is the useful, and the useful is that which has enabled the group to win out in its struggle with other groups, and as in the process of social and industrial evolution economic productivity has been found to be above all else that which makes for group success, therefore the most moral man is the one who contributes most to the strength of the group. By this yardstick the rich parasite who consumes more than he produces, is highly immoral.

Men should be moral, then, because only thus are they of value to their group, and the very fact that they are of value makes them moral. Morality, however, has to do not only with economic productivity but also with the relations of man to his fellow-men within the sovereign group, in other words, with social adaptation. Lack of homogeneity and friction within the group tend to weaken it in competition with other groups, hence are evil. Morality requires a man to be socially efficient and that means development of personal efficiency, physical and mental, and such response to his social environment as to make for co-operation and social adjustment. The so-called vices are morally bad, not because they violate any divine command, but because they make for personal and social mal-adaptation.<sup>2</sup>

<sup>1</sup> *Essays in Social Justice*, pp. 14 f.

<sup>2</sup> *Principles of Rural Economics*, p. 187.

Self-control is a virtue, for only through it can social adjustment be secured. This self-control must be extended to the procreative impulse, for the bringing into the world of those who, because of defect in the organism or deficiency in training, cannot be socially efficient, is immoral.

Each sovereign group is called upon to work out its own salvation and to struggle for world-mastery, and in so doing every act is justifiable and good which gives promise of securing this result. Under this system of group ethics we may conceivably have a double standard even as has prevailed from earliest times; i. e., a code of conduct may be used in dealing with foreign groups or representatives of these groups which would not be used in intra-group relations. Such a group ethics is justified by Professor Carver on the following grounds:—

1. Group success furnishes a test of the good and true. This is a pragmatic test based on the neo-Darwinian theory of biological evolution applied to society. The good and the true are not absolute, but relative to group success. What is right in one age and nation may be wrong in another.

2. By inter-group rivalry we have the only adequate method of evolving the most efficient social organization. We have no other test than just this of workability. That form of organization is best which makes the group most efficient in competition with other groups.

3. By this method, also, the largest degree of individual well-being is secured, for individual happiness is linked with group success. In primitive struggles the losing group was annihilated or enslaved. In the modern struggle for the markets of the world the losing group will be thrown back ultimately on its own resources and forced to remain a poverty-stricken agricultural nation with limited population or accept the lowest wage for manufacturing, except as location and resources give it monopolistic advantages. The group winning because of economic efficiency can increase in population, power and wealth with accompanying largeness of life.

Finally, although the emphasis is on group success, Professor Carver believes that this gospel of productivity provides the only

method of securing the ultimate triumph of that civilization which would bring maximum well-being to all individuals, — or in religious terminology, the triumph of the kingdom of God. Most sociologists accept as inevitable the historic cycle of the rise and fall of nations. Passing from a pain to pleasure economy, to use Professor Patten's phraseology, consumption comes to be regarded as an end and the nation thus worshipping at the shrine of pleasure, falls a victim before a powerful group still struggling in the productive stage. The nation that would become immortal and carry its civilization with its government and religion to the farthest parts of the inhabitable globe, must accept the gospel of the productive life, grow in population and wealth, win the markets of the world, colonize, take possession of unoccupied territory, force back the social laggards and ultimately, and by sheer force of efficiency, possess the earth.

Religious sanction for such a program is claimed from the teachings of Jesus.

The perception of this great economic principle of valuation, and the application of it to non-commercial objects, such as mental and moral qualities, is the leading characteristic of Christ's teaching respecting the Kingdom of God. He who gives much and takes little, whose service exceeds his demands by the largest margin, is greatest in the Kingdom. The Kingdom of God, as set forth by its greatest expounder, is nothing more nor less than a kingdom in which this principle of valuation prevails. That is the only objective characteristic of the Kingdom which he ever emphasized. The nation which adopts the same principle of valuation as its basis of selection will approximate as nearly to the ideal of the Kingdom as is possible in a world of physical reality.

This is the only conception of a Kingdom of God on earth which is possible to a person who believes that this physical world is God's world and that the laws of selection now in operation are God's laws. If that be true, the kind of a group which best meets the conditions and requirements of this struggle and survival, and which can therefore win the world in competition with all other forms and types of social organization, must, of logical necessity, be God's Kingdom. That group will survive which evaluates most accurately the fitness of its men to help in the struggle, and which distributes power and responsibility on the basis of that fitness.<sup>1</sup>

As to the psychical factors involved in the historical and present process of passive social adaptation, our author has not contributed anything new. In this field he has followed, in general, the

<sup>1</sup> *The Religion Worth Having*, pp. 76, 77.

lead of those from whose writings he has made selection in his *Sociology and Social Progress*.

The importance of formal education as a method of social adaptation is stressed and his constructive social philosophy provides an educational goal of "social efficiency" and a principle of value in educational management.

In the discussion of "Active Social Adaptation" the emphasis is on social control, but the process is illustrated also in the *innovator* and *moral reformer* who try to adapt their social environment to their personal ideals of the right and good, although this latter part is not stressed.

Social control is necessary largely because the social instincts have not as yet been sufficiently developed to secure by spontaneous action the type of social life that is most efficient. In discussing this subject Professor Carver sounds another comparatively new note for the function of government is considered to be pre-eminently that of suppressing uneconomic competition and of encouraging economic co-operation. As competition among the lower biological orders is advantageous in the development of the species so is it in society. The competitive industrial system which rewards according to merit gives the meritorious the opportunity to succeed in the struggle and leave the largest number of offspring as a social asset. But not all competition is economic. Co-operation within the group is essential to strengthen it for its inter-group struggle.<sup>1</sup>

The abstract discussion of individual rights and the limits of social control is vain. With the sovereign group, might is right, and the individual has no rights apart from social utility.<sup>2</sup> There is no real issue as to woman's rights in the matter of suffrage. It is purely a matter of social expediency, and Professor Carver does not believe it is expedient.

One of the great problems for social control in the line of social efficiency is the improvement of the quality of the race-stock. This opens up the whole question of eugenics which is considered to be of the greatest importance.<sup>3</sup> Family pride, especially

<sup>1</sup> *The Religion Worth Having*, pp. 42 f., 88 ff.; *Essays in Social Justice*, ch. V.

<sup>2</sup> Class lectures; *Essays in Social Justice*, ch. I.

<sup>3</sup> *Principles of Rural Economics*, pp. 354 ff.

among the most efficient is emphasized as of the greatest value in helping to counter-balance the increase of population which is now so largely from the lowest economic classes. As noticed above, economic efficiency is considered by our author to be the best principle of selection yet discovered, though he admits that this principle is not now working because of the practical sterility of the most efficient.

Regulation of marriage as well as of divorce should be a function of the sovereign group. A minimum wage law rigidly enforced is considered one of the feasible methods for race-stock improvement, for the incapables would be thrown upon society for subsistence and by segregating these the race-stock would be improved in an appreciable degree within a few generations.

As the chief function of social control is considered to be the economizing of human energy, all forms of waste must be eliminated. Professor Carver gives attention to two in particular, waste land and waste labor. The following scheme sets forth his analysis of these forms of waste:—

Causes of waste land <sup>1</sup>	{	1. Bad physical conditions	{	(a) Too stony,
				(b) Too wet,
				(c) Too dry.
		2. Bad chemical conditions	{	(a) Too much acid,
				(b) Too much alkali.
		3. Bad social conditions	{	(a) Bad taxation,
				(b) Too much speculation.

Forms of waste labor <sup>2</sup>	{	1. The involuntarily unemployed.
		2. The imperfectly employed.
		3. The improperly employed.
		4. The voluntarily idle.

The class of involuntarily unemployed is made up mostly of defective individuals; the imperfectly employed of those whose idleness is due to enforced "lay-offs" and seasonal occupations; the improperly employed, of those who are not doing the work for which they are best adapted and the voluntarily idle, of the tramps and idle rich. There are two classes of the latter, those who have produced sufficient wealth for their maintenance and have retired from the productive life, and those whose sole occu-

<sup>1</sup> *Principles of Rural Economics*, p. 132.

<sup>2</sup> *Ibid.*, p. 185.



tion is to spend what others have produced. Society's most serious problem is with the fourth class, and especially with the idle rich whose talents presumably are above the average and who could thus be of great value to society as producers.

This gospel of the productive life is applied to the problem of social service concerning which so much is being said and written of late.

The result is that as much cant is being preached in the name of social service as ever was preached in the name of spirituality. This is to be expected of those who do not realize that all productive work such as growing corn, wheat or cattle to feed the world, or growing wool or cotton to clothe the world, is social service; and that the best social service which the average man can perform is to do his regular work well, — to grow good crops if he is a farmer, and to bring up his family in habits of industry, sobriety, thrift and reliability, and mutual happiness; that anything, in short, is social service which builds up the country and makes it strong, powerful, progressive and prosperous.<sup>1</sup>

One other kind of adaptation is suggested by Professor Carver but not labeled, — the adaptation of man and society to the evolving cosmic process, phrased by John Fiske as religious adaptation. It is implied where the thought is emphasized that this is God's world and that the highest type of obedience is to find out God's will as revealed in the cosmic process, and having found out, conform both individual and social life to that will.<sup>2</sup>

Progress by struggle and survival is God's will for it is God's way. Success for the individual man and the race by the economizing of human energy, and by testing all consumption by its bearing on future production is also God's will for it is God's way. Support is found, too, in interpreting God's will, by appeal to the Bible, and especially to the words of the Great Teacher.

Amid the pessimistic utterances of those who see the inevitable downfall of the Anglo-Saxon race in accordance with those laws that have effected the downfall of the other great races which have become rich, effete, and thus the prey of stronger, struggling races, Professor Carver utters a strong prophetic message of hope, — but on one condition: "Repent or ye shall all likewise

<sup>1</sup> *Principles of Rural Economics*, p. 355; *Essays in Social Justice*, ch. XVI.

<sup>2</sup> *The Religion Worth Having*, pp. 85 f.

perish," — and repentance means turning from the " pig-trough " to the " work-bench " philosophy of life; turning from the ideal of " graceful consumption " and " eminent leisure " to that of production, of the economizing of human energy, and of consumption not as an end but as a means to further production.

This social theory, like all " prophecies " will meet with theoretical and practical opposition. It will be opposed on the latter side by those who have been taught by experience that sole emphasis on one phase of life is narrowing and deadening and who do not believe that a race can be evolved which can combine this excessive emphasis on the production of material goods and on reproduction, with emphasis on cultural values to the degree assumed by our author, and to the degree required to make his theory effective. It will be opposed on this side, too, by those who live to consume.

On the theoretical side it is open to criticism along the following lines: —

(1) It is logical and abstract and of value as a social philosophy in proportion as its premises are true, but even so, it is concerned too largely with " by-and-large " and " in-the-long-run " without sufficient regard to individual, concrete conditions.

(2) It is built up on a rigid application to social progress of the neo-Darwinian formula for biological evolution and fails to be convincing just in proportion (*a*) as this formula fails to explain biological evolution, and (*b*) in proportion as this formula needs to be modified or is shown to be inapplicable to social evolution.

(3) Over-emphasis is placed on the sovereign, territorial group as the sociological unit. There seems good reason for holding, on the contrary, that the sovereign group is not an end in itself, but only a means to the well-being of the largest possible number of individuals and it is by no means certain that this result can be attained only by the conflict between territorial groups.

(4) In his desire to give prominence to the objective standard of the good, the right and the just, Professor Carver has denied all worth to motive as such; but a man's attitude toward life, his ideal, his intelligent purpose are most potent factors in enabling him to find that place and do that task which shall prove most

serviceable to the group.<sup>1</sup> "Hearty" co-operation between an employer and his employees has proven to result in increased production. An employer who is interested merely in output may introduce a system of profit-sharing or welfare work with the sole purpose of securing increased dividends, another employer may be interested in his men as fellow human beings and co-workers in increasing the well-being of the community and sovereign group, and work directly to foster this spirit of co-operation. Surely this latter attitude on the part of an employer is a desirable quality to emphasize and the one having such an attitude is on the whole more apt to secure the co-operation of his employees than the one who does not have it. To be sure the important thing is the result,—but to emphasize the worth of the attitude or motive and the *duty* of having such an attitude would seem to be of some intrinsic value.

(5) His psychological analyses are not satisfactory. The individual is always set over against other individuals or groups with emphasis on conscious conflict of interests and a solution of the conflict is sought on the basis of rational self-interest.<sup>2</sup> Modern social psychologists, as Baldwin, McDougall, Dewey, Ellwood *et al.*, have shown how the self-regarding sentiment expands to include other individuals in such a way as to prevent the consciousness of conflict, or to reduce it to a minimum through co-operation for the attainment of a common purpose. There is not ordinarily such a cold calculation of interests as assumed. Most responses of the ego are to interests which are either instinctive or developed by social experience and education. These responses are for the most part automatic rather than reflective and controlled by social impulses, by a sense of duty, by regard for public opinion and other motives working to a very large extent below the threshold of consciousness.

(6) The theory in question does not make sufficient place for rational imitation, individual and social, as a method of social advance, nor for the possibility of race-stock improvement by this method linked with social control.<sup>3</sup> If our interest is in

<sup>1</sup> *Essays in Social Justice*, p. 4.

<sup>3</sup> Mentioned, however, *Essays*, ch. V.

<sup>2</sup> *Ibid.*, ch. III.

humanity rather than in the success of the territorial group we may well believe that wise social control of the defective class in one group would be reflectively imitated by others and result ultimately in a higher type of physical organism and psychical endowment for humanity as a whole than we have reason to believe would result merely from inter-group conflict even of the commercial type.

(7) The appeal to Biblical sanction for the "productive life" as interpreted by our author, is questionable. It is not difficult to find support for such a doctrine in the parable of the ten talents, but it is not so easy to interpret thus the parable of the lord of the vineyard who rewarded alike the workmen commencing at the third hour and the one at the eleventh hour, thus apparently negating the theory that motives do not count; nor does it "feel" like the Gospel of the Kingdom as proclaimed by Jesus with emphasis on obedience to the will of God, love toward even one's enemies, and such service as can hardly be interpreted in terms of "self-centered appreciation" and inter-group competition. We believe that the constructive theory outlined in our conclusion is more in harmony with Biblical teaching.

Despite these points which are at least open to question, Professor Carver's social philosophy is most suggestive and stimulating, and illuminating, too, in helping one to understand the present European war which is the result in large measure of the commercial rivalry between Germany and England. It is a social philosophy very similar to the one under discussion that has caused the marvelous growth and industrial expansion of Germany during the past half-century. On the whole the people of that country have been inspired by a purpose to produce rather than to consume, and ultimately to possess the earth.<sup>1</sup> They have had the vigor, the ambition, — and the conceit, — characteristic of adolescence whether individual or social. But certain of

<sup>1</sup> Professor Carver does not justify Germany's militarism, however, but believes that the desired results might have been attained by populating contiguous territory, buying up the land and eventually by annexation. A coalition of nations jealous of success was almost inevitable in any case with war as a result. Indeed war seems to be the logical outcome of such a social theory with so great emphasis on the success of the territorial group.

the wisest of English social philosophers have seen the inevitable outcome of such commercial rivalry and have called their countrymen to rally to the industrial and political defence of their fatherland,<sup>1</sup> — and these two are peculiarly linked in England. The commercial rivalry between these two sovereign groups has resulted in the development in each of a strong national consciousness and in methods of education and social control having as their aim the strengthening of the group and the securing of greater efficiency and well-being among the people. The war has called attention to various forms of waste of human energy, — as from the excessive use of alcohol, — and thought is being given to a solution of the problem. It is almost certain that one of the results of this war will be to make acceptable to all western nations a program of social control very similar to that outlined by Professor Carver,<sup>2</sup> and if so, it will not take many years to secure for the people of these nations a degree of well-being which might not have come otherwise in centuries. Should the other nations of Europe adopt a program of expansion like that of Germany, the inter-group struggle will become as acute as portrayed by our author and in that event *the nation with the most efficient standard of living* will win out. This, in the view of our author, will probably be the basis of the final conflict.<sup>2</sup>

<sup>1</sup> Cf. Pearson's, *National Life from the Standpoint of Science*.

<sup>2</sup> *Essays*, ch. X, "Constructive Democracy."



PART V

ACTIVE SPIRITUAL ADAPTATION





## CHAPTER XIV

### ACTIVE SOCIAL ADAPTATION

ACTIVE spiritual (including social) adaptation was defined in the Introduction as "the purposeful adjustment of the individual to his spiritual environment, social, ideal and transcendental, the work of true teachers and social reformers, and purposeful social control." We have already noted many contributions to the development of this phase of our subject, but have reserved till now the discussion of it as a specific form of social progress.

This doctrine of active spiritual adaptation has one root in the monism of Schopenhauer with *Will* as the supreme characteristic of the All, especially as this has been interpreted through the writings of Nietzsche (combined in his social philosophy with neo-Darwinism), and through the philosophy of William Wundt with emphasis on "teleology," and adopted in sociology by Ratzenhofer and Ward. It has a second root in the *a priori*ism of Kant which brings into prominence the activity of the ego in the acquirement of knowledge, also in his doctrine of the practical reason with exaltation of the will, especially as this has issued in modern pragmatism. It has a third root in modern social psychology issuing in a kind of social realism with its doctrine of social will.

Since Darwin there has been a growing tendency to fuse these various philosophical teachings and interpret them in terms of life and adaptation. We have noted this tendency in our previous discussions and the contributions to it by various social philosophers, especially important being Tarde's theory of innovation, Bagehot's doctrine of progress by discussion, the teaching of Schäffle and other social psychologists concerning the social will, Ward's theory of individual and social teleosis, and the emphasis placed by Patten and Carver on idealization, religion and social control in the wide-spread production of surplus and its wise use. In this chapter and the next, under "active social adaptation" we will consider Novicow's "hierarchy of

struggles," Carlyle's Great Man theory, James' teaching concerning "Energies of Men," and Ross' Social Control. This will prepare the way for a discussion of idealization and religion or "active spiritual adaptation" in the narrower use of the term.

JACQUES NOVICOW (1849- )

*Social Progress by Cultural Attraction and Expansion*

Although Novicow is given scant recognition by American sociologists, his writings, especially *Les Luttes* are deserving of a prominent place in this book for two reasons: (1) He antedated by many years the four-fold analysis of adaptation worked out independently by Professor Carver which has formed the basis of this present discussion, and (2) his analysis of the European situation with its inter-group rivalry for territorial and commercial expansion is especially worthy of recall now that this rivalry has resulted as he feared and as he tried to prevent by turning the thoughts of cultured men and leaders in social progress to that highest form of conflict, struggle for excellence. His suggestion of a federation of nations is not far removed from that advocated at present by such American exponents of peace as ex-President Taft and Senator Lodge, but he stands almost alone in his emphasis on growth of nations by cultural attraction and expansion rather than by territorial or even commercial. This last point is particularly noteworthy in our present discussion and warrants his consideration in this division of our subject rather than earlier where the date of his writing and his biological and psychological postulates would otherwise cause him to be placed.

Novicow begins his study of "conflicts" by showing that struggle and alliance are twin phenomena in all cosmic evolution, — that "the universe is a totality of systems being continually formed and broken up." He holds, moreover, that "the groupings which we consider as irreducible units, the molecule, cell, individual, state, for example, are pure subjective categories of the mind"<sup>1</sup> as are also the divisions between the sciences.<sup>2</sup>

Passing from the domain of the inanimate to that of the animate, he shows that there are struggles not only between associa-

<sup>1</sup> *Les Luttes*, p. 5.

<sup>2</sup> *Ibid.*, pp. 7 f.

tional groups, animal and human, but between organisms within the group, and not only between organisms but among cells in an organism; that there is struggle between psychical elements resulting in consciousness; struggle for mastery between thoughts; struggle between industries; — struggle everywhere, but everywhere, also, *alliance*. He holds, moreover, that as no definite point can be fixed at which the associational process begins, so there is no known end until all humanity is organized (in alliance with all useful animals under domestication) in a struggle against inanimate nature and disuseful animals.<sup>1</sup>

Considering the different forms of struggle between living beings, our author says that there are two fundamental divisions: (1) those having as their purpose the assimilation more or less complete of the elements of the conquered to the advantage of the conqueror, — in a word, *absorption*, and (2) those having as their purpose the removal of an obstacle in the way of the attainment of the vital end of the individual, — in a word, *elimination*. Each of these is shown to have two phases: attack and defense; i. e., “living things struggle to absorb or eliminate others, on the one hand, and on the other, to preserve themselves from absorption or elimination.”<sup>2</sup> In the vegetable world, and between herbivorous animals, the struggle results in elimination; between animals and plants and between carnivorous animals it is chiefly one of absorption. In general, plants are subordinated to animals, weak animals to strong, and both plants and animals to man. These biological processes have their analogue in the forms of struggle between social groups.<sup>3</sup>

Struggle and alliance, according to Novicow, work in accordance with the law of adaptation and will always be in evidence, for absolute adjustment or equilibrium is impossible as the universe is in a state of perpetual creation or transformation.

In biological evolution we have passive physical adaptation as a result of the impact of external nature on the organism and active adaptation in a more or less telic effort put forth by a portion of the organism<sup>4</sup> to facilitate adaptation. This he calls production. Continuing he says: —

<sup>1</sup> *Les Luites*, p. 30.

<sup>2</sup> *Ibid.*, p. 19.

<sup>3</sup> *Ibid.*, pp. 21 f.

<sup>4</sup> This theory, formulated by Lamarck, is now discredited.

Adaptation to the physical environment is science. . . . The totality of the human sciences elaborates a conception of the universe as complete as possible and if this conception were perfect the adaptation of man to his cosmic environment would be absolute.<sup>1</sup>

The influence which one organism exerts on another is strong in proportion to their resemblance or to their affinity. In that case movements produced by one organism are reproduced spontaneously by the other. . . . Imitation is passive adaptation to the social environment.<sup>2</sup> . . .

Active adaptation to the physical environment has the same name in sociology as in biology, — production. As the mental horizon of man is much higher than that of animals he foresees the possibility of adapting his environment to his needs in a greater measure. Moreover as his faculty of prevision becomes greater, production takes two forms: man can transform external objects for his immediate use but he can also create utilities to enable him to adapt a portion of the planet to his needs (as digging canals, draining swamps, irrigating arid lands, etc.). . . . Organization and biological tools on the one hand and science and social tools on the other are in the closest co-ordination. . . .

The active adaptation of the social environment can be designated by the general term love. Indeed to love any one is to desire to make that person like oneself. Charity has for its goal to procure for others the material well-being which we ourselves enjoy. The apostle, the propagandist, have for their aim to lead others to think as they do. Charity and propaganda are the two forms which bring about the active adaptation of the social environment.<sup>3</sup>

The forms and processes of adaptation as explained by Novicow are shown in the following diagram: <sup>4</sup> —

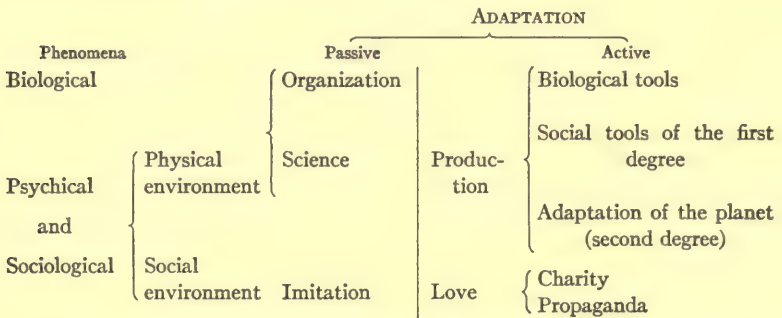

<sup>1</sup> Novicow with Aristotle identifies knowledge with power, but man's actual adaptation to his environment is never on a par with his knowledge.

<sup>2</sup> Here our author follows the now discarded theory of instinctive imitation. Such a theory fails to give sufficient prominence to individuality and the satisfaction of individual interests by instinct and habit.

<sup>3</sup> *Les Luites*, pp. 38-40.

<sup>4</sup> *Ibid.*, p. 41.

Passive adaptation (science) and active adaptation (production) go together, reacting on each other constantly. The more easily one receives impressions from without the more easily does he act on that which is external. . . . The struggle for existence results in the survival of the most apt. Now, *most apt* from the point of view of psychology is synonymous with most intelligent. . . . Man has conquered the animals because he was able to adapt himself more quickly to his environment than other living species, or (what is exactly the same thing) because he was the most intelligent.

What one calls intellectual culture is also a form of adaptation to the environment. Cultured man possesses a more or less complete representation of the universe and sums up in himself the mental labors of humanity. His horizon is greatly extended in space and time and this means that he is capable of representing to himself a great number of images and states of consciousness. . . . The struggle for existence assures the victory to the individuals and societies who possess the most exact conception of the universe.<sup>1</sup>

Novicow goes on to interpret life in terms of rhythm, and adaptation as "eurhythm" and holds that as the change from anarchic movements to those that are co-ordinated requires time, so adaptation, physical, mental and social, also requires time.

The various forms of struggle are analyzed, — the physiological, the economic, the political, the intellectual and those which arise in the domain of sentiment, — and these are shown to form a hierarchy, the most rapid, the most complete, and the most pleasure-giving being in the realms of mind and heart, these latter varieties, too, being the last to be attained. In the physiological realm man has passed from cannibalism (absorption) through murder, plunder and dispossession of territory (elimination), through wars for the possession of women and slaves to provide satisfaction of physiological interests, on to that highest form of struggle between the sexes known as love. "All love is a combat because in all love there is one being who subordinates his life to the ends of the other, hence a vanquished and a vanquisher."<sup>2</sup>

The physiological<sup>3</sup> and economic struggles<sup>4</sup> are practically the same on the lower levels of social life but the latter differentiates as society progresses and finally enters the domain of politics taking the form of invasions, demands for concessions,<sup>5</sup> etc.

<sup>1</sup> *Les Luttes*, p. 42.

<sup>4</sup> *Ibid.*, pp. 73 ff.

<sup>2</sup> *Ibid.*, p. 71.

<sup>5</sup> *Ibid.*, pp. 82 ff.

<sup>3</sup> *Ibid.*, pp. 64 ff.

The political struggle is rooted largely in physiological and economic interests, though later it enters the mental realm and has for its purpose religious coercion. The unit in this struggle is always the territorial group. Inter-group conflicts are held to have two fundamental purposes: (1) group aggrandisement or group safety on the one hand and (2) so-called rights either national or international on the other.

The intellectual struggle<sup>1</sup> comes relatively late and is closely related to the political, i. e., that nation will win out in the long run which has the language that best facilitates intercourse; that knowledge which makes possible the greatest production, hence gives industrial supremacy; that literature which is most inspiring and most successful in securing the "sympathy" of members of other nations; that philosophy which gives the most exact concept of the cosmic order and that religion which is most potent in expanding ideas.<sup>2</sup>

As feeling (le sentiment) is a most important element in struggle and adaptation, this psychological factor is analyzed at some length, but here, as in some other places, Novicow fails to be convincing because of his hedonistic psychology with its whole emphasis on the motives of pleasure-seeking and pain-avoiding. As with Ward, feeling is a "social force" though not labelled thus, and is the dynamic in social attraction and expansion.<sup>3</sup>

All the cultural elements, together with those social characteristics which give zest to life, are most potent in making the winning group.

It is by the totality of moral and intellectual qualities; by the power of seduction; by means of a high culture, artistic development, enthusiastic interest in the researches of science and the speculations of philosophy, that make a country interesting and evoke a sympathetic response in its neighbors. Now such a people attracts strangers. The stranger carries over new ideas and stirs the intellectual movement. This movement favors philosophical speculation. A good philosophical method contributes to the advancement of the sciences. Science leads to the improvement of technique and to the perfecting of social institutions. In turn these two factors [moral and intellectual] increase riches and riches create political power.<sup>4</sup>

<sup>1</sup> *Les Luttes*, pp. 96 ff.

<sup>2</sup> *Ibid.*, pp. 96 f.

<sup>3</sup> *Ibid.*, pp. 112 ff., 164 f.

<sup>4</sup> *Ibid.*, p. 120.

Now this winning quality of evoking sympathy (se rendre sympathique) is incompatible with the use of physical force.

No one can compel love by force. The only way one can evoke sympathy is by possessing the qualities which are admired. If one society experiences admiration for the intellectual culture of another, this admiration provokes sympathy and leads it to imitate the models which are pleasing. *To provoke imitation is the most efficient process in the domain of sentiment.*<sup>1</sup>

Although Novicow's use of the terms *sympathie* and *sympathetique* are not the best in this connection, his emphasis on the importance of "provoking imitation" as a factor in social progress is of the greatest significance in our discussion. The conclusion to his analysis of feeling is as follows:—

The power which one society possesses of assimilating a lower society and its power of radiating influence is in direct proportion to the sympathy it can evoke. Now the ability to absorb strange elements and to make conquests outside are the very conditions of the growth of societies. We conclude, then, that . . . other things being equal, the nation which evokes the most sympathy will be the most powerful.<sup>2</sup>

In discussing "denationalization" Novicow points out the value of homogeneity to a political group and shows how ineffectual are the coercive methods used almost exclusively up to the present time by rulers in their endeavor to assimilate subject peoples differing in language and culture.<sup>3</sup> He condemns the current political theory and practice which make the territory belonging to a nation under the absolute control of the rulers to be disposed of as they wish without regard to the desire of the private owners and occupiers of the land, and holds that migration, alliance, union and realignment of groups should be absolutely free and based entirely on the laws of social attraction or "sympathy." For example he believes that the northern states were not justified in '61 in preventing the secession of the southern states; that Alsace and Lorraine should themselves decide as to whether they would be a part of Germany or France.<sup>4</sup>

The reason assigned for the failure of coercion to secure group homogeneity is the fact noted above that assimilation is a matter of feeling. The "sympathy" of the subject people must be won

<sup>1</sup> *Les Luttes*, pp. 122, 276 ff.

<sup>2</sup> *Ibid.*, p. 127.

<sup>3</sup> *Ibid.*, p. 124.

<sup>4</sup> *Ibid.*, pp. 251, 252.

and then assimilation comes by imitation. It is of greatest importance, for example, that the ruler of such a conglomerate state as Austria-Hungary should have such personal magnetism as to win the affection and loyalty of the people whether Magyar, Italian, German, Jew or Slav. With personal prestige he can win not only by encouraging the spread of culture among the aliens, but even more by personal example exercised first on his friends but ultimately on all throughout the realm.<sup>1</sup>

Justice in all dealings with subject groups is also a supreme requisite in assimilation, and the granting of large civil and political rights.<sup>2</sup>

✓ Passing to an analysis of the successive phases in the development of social consciousness our author shows that just as individual consciousness arises out of struggle and the rupture of mental equilibrium, this rupture resulting either in pleasure or pain,<sup>3</sup> so social consciousness arises only in the presence of the unusual and "startling." Psychic pleasures, he holds, are far higher and more enduring than physiological, hence culture in its varied forms is most important for a group, — and culture tends to be made incarnate in human institutions.

The human body is a totality of organs of service to the psychic life of the brain. Society is a totality of institutions of service for intellectual production. This production is the end of the life of societies and naturally takes first place in national consciousness. In civilized societies the savants, philosophers, religious innovators, authors and artists are in the first rank. Their glory far transcends that of the rich and the men of state.<sup>4</sup>

Novicow shows that social consciousness up to the present has been developed largely by wars and conquests but that it is possible to have as a social goal the expansion of nationalism by intellectual conquest, — by the attractive power of a culture that

<sup>1</sup> "Pour être aimé, il faut être aimable. Aussi, sur ce terrain, le dominateur ne peut agir que par ses qualités personnelles. S'il est intelligent, noble de caractère, loyal, fier, avec cela affable, séduisant, bref s'il a ce prestige magique que donne la supériorité morale, il exerce un grand attrait sur son entourage . . . mais les sentiments se manifestent aussi dans les sociétés par le cérémonial et les moeurs. Ici a dominateur peut agir de nouveau par des mesures législatives, mais naturellement son action la plus puissante s'exerce par l'exemple." — *Les Luttes*, p. 149; cf. pp. 288 f.

<sup>2</sup> *Ibid.*, pp. 290 f.

<sup>3</sup> *Ibid.*, pp. 159 f.

<sup>4</sup> *Ibid.*, p. 166.



evokes sympathy because it promises the highest joys of life.<sup>1</sup> But to raise inter-group conflict to this peaceful, intellectual plane, there must first be a general recognition of the fact that power comes from wealth and wealth from intelligence and morality.<sup>2</sup> Success in the inter-group struggle for existence is thus dependent on psychic factors, — but so is it also, according to our author, among animals.

Beings possessed of a brain have triumphed over those which did not have one. At the moment when animals appeared on the earth endowed with a nervous system, they formed some conception of the universe. It is thus possible to say that struggle between species is at bottom a struggle between different conceptions of the universe.<sup>3</sup>

Almost no one today would agree with Novicow in thus attributing to the lower orders a power of abstraction so potent in the struggle for life. A life philosophy is potent, however, in the social struggle. India and China, for example, can never become progressive so long as they are dominated the one by mysticism, the other by ancestor worship.

As adaptation is synonymous with intelligence, according to our author, and as intelligence is continually increasing, we have in this fact a test of progress. Indeed this increase of intelligence is progress.<sup>4</sup> The connection between intellectual progress, struggle and adaptation is expressed thus: —

The more perfect a species becomes the more the individuals composing it multiply (human beings, for example, are far more numerous than other mammals), and the greater is the rivalry. The more violent the conflict, the more rapid are the physiological and psychological changes because of the importance for success of each point of advantage. That is, progress is in direct ratio to competition.<sup>5</sup>

Novicow sounds a new note in sociological discussion in his doctrine that the way for a society to preserve its national type is through imitation.

<sup>1</sup> *Les Luttes*, pp. 178 f.

<sup>2</sup> *Ibid.*, p. 182.

<sup>3</sup> *Ibid.*, p. 188.

<sup>4</sup> Or, comme adaptation est synonyme d'intelligence, on voit que c'est en vertu des lois universelles de la nature, que l'intelligence va toujours en s'accroissant. Cet accroissement s'appelle le progrès. — *Ibid.*, p. 188.

<sup>5</sup> *Ibid.*, p. 189. This is a misstatement, for as Spencer has shown, reproduction decreases with biological evolution.

If a society desires to preserve its type, it should possess a sum total of mental activity equal to that of all its rivals; i. e., it ought to assimilate all the ideas of its neighbors. As soon as a society is not capable of this effort its denationalization is inevitable, its type is condemned. Passion for the new, then, is a special sign by which one can recognize that a nation is still in its period of growth. The connoisseur of spiritual things who is on the watch for every fresh exotic production, preserves his nation from stagnation and torpor. To understand everything, to feel everything, — this it is that makes the grandeur of nations as of individuals.<sup>1</sup>

That imitation as here used is not merely instinctive but rather reflective is shown not only by use of the simile expressed by the word connoisseur but also by the following: —

To provoke imitation is to attack; to endure a propaganda (or a system of teaching) with the purpose of selecting parts for personal advancement is to defend oneself. Now it is absolutely impossible to impose imitation by violent methods since such methods stir up antagonistic feelings which act by way of constraint. One can only provoke imitation. The nations which have this faculty in a high degree win out in the struggle for existence while those who have it in a low degree, fail. . . . Imitation varies, naturally, within wide limits. Up to a certain point it preserves national individuality but carried further it can destroy it. . . . The societies which know how to preserve a just balance . . . prosper; those who do not know how, perish.<sup>2</sup>

The means which assure mental preponderance, i. e., assimilation and expansion, are exactly analogous to those which today assure political preponderance: organization and equipment (outillage). The battle of the future is to be between ideas rather than armies, and for this intellectual struggle artists, poets, savants and women are needed.<sup>3</sup> Moreover there is need of an organization of peaceful propaganda.<sup>4</sup> The outcome will be the amelioration of every department of life. Among other things there will be an increase in the individuality of nations.

Each nation will endeavor to be self-sufficient, to individualize. Individuality is most marked among the most advanced civilizations. All savages are alike. To produce characters as different as Dante, Michael Angelo and Spinoza requires high intellectual culture in a group. In the first place division of labor is proportional to the degree of civilization. . . . But division of labor is true of societies with relation to humanity. After having attempted to cultivate in the same degree the totality of human knowledge there may come a time when nations will specialize, — certain nations, for example, having greater aptitude for the natural sciences will cultivate them in preference to the social sciences.<sup>5</sup>

<sup>1</sup> *Les Luttes*, p. 301; cf. p. 541.

<sup>3</sup> *Ibid.*, pp. 305 f.

<sup>5</sup> *Ibid.*, p. 324.

<sup>2</sup> *Ibid.*, p. 303.

<sup>4</sup> *Ibid.*, p. 438.

Contrary to the school of Treitschke, Novicow holds that war is not necessary to keep alive national spirit, but on the contrary, that the collective desire for intellectual supremacy will prove far more potent. Indeed the state is not the final form of human association, he holds, but even now that form known as "nationality," i. e., a group united by the bonds of cultural likeness and sympathy. Such intellectual rivalry, moreover, will provide the largest possible well-being and happiness, for intellectual activity is the very quintessence of life and pleasure.<sup>1</sup>

To live signifies to think, to feel, to will, to act; and the more vibrant the thought, the more profound the feeling, the more ardent the desire, the quicker the action and the more rapid the changes, the more intense is the life. . . . The law of acceleration which pervades all nature is also at work in the evolution of societies. Passing from the physiological phase through the economic and political, the struggle for existence ends with the intellectual phase where it attains its greatest intensity. When the nations shall have entered this struggle definitely, when the social transformations which it demands shall have been completely effected, there will be an activity and an intensity of movement throughout humanity in comparison with which our actual existence will appear to be mere lethargy.<sup>2</sup>

The hierarchy of human struggles culminating in free assimilation and in the provoking of imitation is shown in the diagram on the next page.

In a panoramic review of human struggles our author deduces several laws: —

(1) "Progress consists merely in abandoning the slower processes of adaptation to environment to adopt those that are more rapid."<sup>3</sup> But as this change is wholly dependent on the increase of knowledge and intelligence, progress may be defined as a progressive change from non-rational to rational processes or from passive to active adaptation.

(2) Self-interest has always been the mainspring of struggle and progress yet the unlooked-for result has been increasing advantage to the conquered and increasing social solidarity.<sup>4</sup>

(3) Methods and processes that are effective in the lower phases of struggle are not effective in the higher, as coercion, for example, in social assimilation.<sup>5</sup>

<sup>1</sup> *Les Luttes*, pp. 327, 410, 434.

<sup>2</sup> *Ibid.*, pp. 328, 329.

<sup>3</sup> *Ibid.*, p. 404.

<sup>4</sup> *Ibid.*, p. 406.

<sup>5</sup> *Ibid.*, p. 416.

TABLEAU OF HUMAN STRUGGLES<sup>1</sup>

PHASES	MODES	PURPOSE	PROCESSES	SLOW (IRRATIONAL) <sup>2</sup>	RAPID (RATIONAL)
Physiological	{ By absorption	Nourishment	Killing his own kind to eat	Cannibalism	(Homicide) <sup>3</sup> Producing inferior beings for food
	{ By elimination			Raids, appropriating food	(Brigandage) Producing food
Economic	{ Temporary	Private immovable goods	Killing or threatening to kill to secure goods	Raids, appropriating riches and slaves	(Brigandage) Producing for a better market than one's competitors and more quickly.
	{ Permanent			Confiscation of lands, houses, with bondage and servitude	(Usurpation)
Political	{ Temporary	Riches	Public movable riches	War tax	(Robbery by armed force) Governing well and increasing the revenues of the country.
	{ Permanent			Permanent tribute	(Spoliation, enslavement, servitude) (Monopoly rights) Leading foreign states to desire annexation, forming federations
Intellectual	{ Temporary	Mental satisfactions	The indirect profits of the government	Conquest. Political places and rights for the advantage of the conqueror <sup>4</sup>	Carrying on a propaganda, to spread ideas by persuasion
	{ Permanent			Religious wars, persecutions	(Intolerance) Free assimilation Provoking imitation
		A type of civilization	Coercive denationalization <sup>5</sup>		

these processes function naturally. They are irrational only on the part of the assailant.

<sup>3</sup> The terms in parentheses signify the judicial or usual terms.

<sup>4</sup> The phase in which civilized societies believe they are today.

<sup>5</sup> The phase in which civilized societies really are today.

<sup>1</sup> Opp. p. 493; cf. also p. 462.

<sup>2</sup> These processes also occur in the defensive form. Persons kill others to prevent being eaten, or persons threaten to kill others in order not to be dispossessed of their goods, in order not to deliver to strangers the profits of the government, to have the right to speak, etc. When the question is one of defense

(4) The different forms of social conflict are merely a continuation of astronomical and biological processes to be interpreted in terms of movement, rhythm, equilibrium and adaptation. "Matter tends constantly toward equilibrium. Biological equilibrium is adaptation to environment. Adaptation to environment is a correlation between exterior objects and their interior image, i. e., truth. Truth is the suppression of the notions of space and time." He goes on to show that as the economy of time leads to association, at first between cells, finally between millions of men, we are compelled to believe that an extension of association would lead to still great economy of time and increase of human well-being, hence to the suppression of war as the general rule of social life.<sup>1</sup>

As peace means death whereas conflict means life, conservatism in a society means death whereas liberalism and rapidity of change mean life. Nor does conflict necessarily produce pain. Defeat is painful but not struggle as such. Work, for example, is painful only when of a certain kind and carried on too long. Nor, again, does struggle for existence necessarily engender hatred. Industrial competition, for example, leads to co-operation and co-operation deadens the hatred stirred up by rivalry. Thus while conflict may arouse hatred it also unites men against a common enemy. The ideal of struggle, then, is that it be carried on with courtesy, that it lead to loyalty, and that it unite as many as possible in a common purpose. These conditions are fulfilled best when struggle is on the intellectual plane.<sup>2</sup>

After discussing the application of these principles to "security"<sup>3</sup> and "justice"<sup>4</sup> (including international), our author passes to a consideration of the interests of the units composing social groups.

Novicow agrees with Ferrière as against Spencer that in the biological organism as well as in the social, the whole exists for the good of the parts.<sup>5</sup> Each individual, he holds, tends to secure the greatest amount of happiness possible but he insists that the first condition of this is to adapt the earth to his needs in the

<sup>1</sup> *Les Luttes*, pp. 426 f.

<sup>2</sup> *Ibid.*, pp. 458 f.

<sup>3</sup> *Ibid.*, pp. 461 ff.

<sup>4</sup> *Ibid.*, pp. 481 f.

<sup>5</sup> *Ibid.*, p. 532.

greatest possible degree. "To live the best possible, this is the end of every member of society."<sup>1</sup> With this end in view, how the earth is divided among different political groups is of as little importance as the administrative divisions in the case of a state.<sup>2</sup>

How self-interest leads to social solidarity is brought out in his theory of the scale of interests: "To be the richest in the richest society; to be the first in the most powerful society; to be a part of the most civilized nationality, — this is the individual point of view. But considering each nation as a unit in a still higher order we may say that each society is interested in being the richest among the richest societies; the best organized (the most perfect) among the best organized; the most civilized among the most civilized."<sup>3</sup> In answer to the question as to how one can enrich himself without impoverishing another, he says: "By producing the most riches in the shortest time." So one can surpass others in intelligence without diminishing the development of society "by imposing his ideas on others merely by the power of persuasion."<sup>3</sup>

The continuity of organic, including social evolution is brought out in the following: —

To climb the ladder of being constitutes the interest of every living creature from the smallest microbe to the greatest nation. To be the most intelligent animal assures the victory over other animals. To be rich gives the possibility of cultivating the mental powers; to be rich and intelligent gives the possibility of occupying the foremost place in the state, and this, in turn, furnishes the opportunity of adapting one's social environment most quickly to one's needs. To be part of the richest society permits one to profit by the most complete material and mental equipment. This equipment gives political power and political power, in turn, assures the most rapid extension of nationality.<sup>3</sup>

Finally, self-interest and emphasis on rivalry in excellence leads to international solidarity, — all co-operating for the conquest of nature to secure the greatest possible satisfaction of human needs.<sup>4</sup>

That which causes suffering to humanity is the lack of adaptation between man and nature. When men come to understand that their true enemy is

<sup>1</sup> *Les Luttes*, p. 544.

<sup>2</sup> *Ibid.*, p. 547.

<sup>3</sup> *Ibid.*, p. 553.

<sup>4</sup> *Ibid.*, p. 571.

the inorganic world they will realize their solidarity. The differences which divide them are merely the toys of a child in the face of terrible dangers which come from nature who like a cruel foster-mother condemns millions of human creatures to misery and famine. Incapable of seeing what is their true enemy, — thanks to their dulness of mind, — men, divided, succumb by millions to the onslaughts of nature.<sup>1</sup>

The real worth of Novicow's contribution to social theory has been obscured by the many fallacies in his reasoning due chiefly to false postulates in biology and psychology. The *self-interest* that leads to co-operation is not merely the empirical self but the *conjunct self*, — to use the phrase of Professor Palmer,<sup>2</sup> — and this conjunct self, in turn, is the product of co-operation. The phenomena to be interpreted are individuals and groups struggling for existence. This struggle leads to co-operation and co-operation to an extension of self-consciousness and the self-regarding sentiment. At times the empirical self stands out over against some social group but again it is merged in the group. Now government, ideally, is nothing more or less than the corporate activity of the members of a group to secure their greatest individual well-being and the survival and expansion of the group. Any activity, therefore, is proper for the government which promises this result.

But again, Novicow's dual interest in emphasizing struggle on the intellectual plane, and individualism linked with *laissez faire* doctrine, has led him to confuse theoretical and practical measures, forgetting that as societies are now below the plane of struggle for excellency they cannot at present use merely those methods which belong to the latest phase of social evolution. Free trade, unrestricted immigration and absolute liberty in making and breaking alliances among border groups may be in harmony with social self-interest in some cases, but not in all at present. Nor is the endeavor to secure national homogeneity always consistent with unrestricted immigration. Our author shows lamentable ignorance of the practical phenomena of large scale immigration, segregation and race prejudice as a menace to homogeneity in some sections of the United States.

<sup>1</sup> *Les Luttes*, p. 572.

<sup>2</sup> *The Nature of Goodness*, pp. 170 f.

His theory is open to the same criticism as that of the neo-Darwinians: The inter-group rivalry is not so keen as to eliminate all but the best adapted, hence emphasis on mere activity and the assimilation of everything, is a dangerous doctrine. Activity and adaptation are by no means in direct ratio, nor are intelligence and adaptation.

Notwithstanding these shortcomings his four-fold analysis of adaptation with emphasis on active material adaptation interpreted in terms of the increasing elimination of space and time, and on active social adaptation secured by means of reflective imitation and the provoking of imitation in others through the power of an attractive example, together with his teaching concerning the hierarchy of struggles culminating in group rivalry for excellence, especially cultural, warrant *Les Luttes* being given the prominent place accorded it in this discussion.



## CHAPTER XV

### ACTIVE SOCIAL ADAPTATION (CONTINUED)

THOMAS CARLYLE (1795-1881)

#### *The Rôle of the Great Man*

Though antedating the period selected for the main part of our discussion, the great man theory of Carlyle has been too important in modern history, literature and social writings to be passed by without mention. Himself a genius, a prophet, a teacher, a moral reformer, he appreciated the contributions to social progress of those in whose souls and lives the best in others had been fused, and who gave it back to the world not only with the stamp of their personality but in such form and with such energy as to stir up new currents of thought, feeling and activity destined to change the whole flow of human history. But not only do great men give back to their fellow-men in new form what they have received, he holds, but great men are in touch with the divine. The spark that lights their souls and fires their wills is not of the earth, earthy, but from above. "The history of what man has accomplished in this world," he says, "is at bottom the history of the great men who have worked here. They were the leaders of men, these great ones, the modelers, patterns, and in a wide sense creators, of whatsoever the general mass of men contrived to do or to attain; all things that we see standing accomplished in the world are properly the outer material result, the practical realization and embodiment of thoughts that dwelt in the great men sent into the world; the soul of the whole world's history, it may justly be considered, were the history of these. . . . No time need have gone to ruin, could it have *found* a man great enough, a man wise and good enough; wisdom to discern truly what the time wanted, valor to lead it on the right road thither; these are the salvation of any time. But I liken common languid times, with their unbelief, distress, perplexity, with their languid doubting characters and embarrassed circumstances, impotently crumbling

down into ever worse distress towards final ruin; — all this I liken to dry dead fuel, waiting for the lightning out of heaven that shall kindle it. The great man, with his free force direct out of God's own hand, is the lightning. His word is the wise healing word which all can believe in. All blazes round him now, when he has once struck on it, into fire like his own. The dry mouldering sticks are thought to have called him forth. They did want him greatly; but as to calling him forth! — Those are critics of small vision, I think, who cry: 'See, is it not the sticks that made the fire?' . . . There is no sadder symptom of a generation than such general blindness to the spiritual lightning, with faith only in the heap of barren dead fuel."<sup>1</sup>

Refreshing indeed is this glowing appreciation of the power of personality, — this *reverence* of the great personality after our many excursions into those types of social philosophy which see only the great cosmic machine with man but a cog!

Carlyle makes practical application of the above thesis to his own time in England, — England suffering from a dearth of great men, — England but "dry mouldering sticks" awaiting the kindling touch of genius. He finds an analogy to the political and social condition of his day and a key to the solution of the problem in the condition of the monastery of St. Edmundsbury in the twelfth century and the reconstructive work of Abbot Samson as portrayed in the Chronicles of Jocelin.

Abbot Samson, we are told, was not a high dignitary but only *sub-Sacrista*; that he had learned during many years of faithful service the great lesson of *obedience* thus being supremely qualified to command; a man "whom no severity would break to complain, and no kindness soften into smiles or thanks." There is something in his selection to the high office of Abbot, too, as told by our author, which is significant of Carlyle's own ideal of selection to public office. He was not chosen by popular vote of any group of people but by a process of "winnowing."<sup>2</sup>

<sup>1</sup> *Heroes and Hero Worship*, Lecture I.

<sup>2</sup> The Chapter selects twelve monks who with the Prior are to confer with the King, the Bishop of Winchester, and the Chancellor, and secure the appointment of an abbot, if possible from their own convent. The thirteen are ordered to nominate three from their monastery and these names are given to the King, —

Samson the poor but *capable* monk is selected for the high office because of the instinctive wisdom of the thirteen. "Great souls, true governors," says our author, "go about under all manner of disguises now as then. . . . Those superstitious blockheads of the Twelfth Century had no telescopes, but they still had an eye; not ballot-boxes, only reverence for Worth, abhorrence of Unworth." He contrasts with this the methods of England's choice that placed George the Third as "head charioteer of the destinies of England" and allowed Burns, the genius and poet "to gauge ale-barrels in the Burg of Dumfries."<sup>1</sup>

Abbot Samson begins at once the task of bringing order out of chaos,<sup>2</sup> and he is able to do this supremely valuable social task because of what he is, because of his power over other men, and because of his unquestioned authority. The character-sketch of this "hero" is worth reproducing: —

In most antiquarian quaint costume, not of garments alone, but of thought, word, action, outlook and position, the substantial figure of a man with eminent nose, bushy brows and clear-flashing eyes, his russet beard growing daily grayer, is visible, engaged in true governing of men. It is beautiful how the chrysalis governing-soul, shaking off its dusty slough and prison, starts forth winged, a true royal soul! Our new Abbot has a right honest unconscious feeling, without insolence as without fear or flutter, of what he is and what others are. A courage to quell the proudest, an honest pity to encourage the humblest. Withal there is a noble reticence in this Lord Abbot: much vain unreason he hears; lays up without response. He is not there to expect reason and nobleness of others; he is there to give them of his own reason and nobleness. Is he not their servant, as we said, who can suffer from them, and for them; bear the burden their poor spindle-limbs totter and stagger under; and, in virtue of *being* their servant, govern them, lead them out of weakness into strength, out of defeat into victory!<sup>3</sup>

The Abbot begins his task with the reconstruction of the material aspects of his great problem, — with a "radical reform of with the addition of three others, — those on the nominating committee each nominating a fellow-member. The King orders three other names added from outside the convent, and then from the nine, orders three names to be struck off, then one declines, two more are ordered struck off, then still another, leaving but two names, those of Samson and the Prior, and of these, the choice is Samson. — *Past and Present*, ch. VIII.

<sup>1</sup> *Past and Present*, p. 86.

<sup>2</sup> "Man is the Missionary of Order; he is the servant not of the Devil and Chaos, but of God and the Universe." — *Ibid.*, p. 91.

<sup>3</sup> *Ibid.*, pp. 89-90.

his economies ” and with much-needed repairs of the Monastery itself. Material rubbish is cleared away, — and spiritual rubbish as well!

Faithful in his immediate tasks at St. Edmundsbury, he is equally faithful to his king in time of war and to his country as a member of Parliament in times of peace. Thus, “ by the heavenly Awe that overshadows earthly business, does Samson, readily in those days, save St. Edmund’s Shrine, and innumerable still more precious things! ”

“ By heavenly Awe! ” — for Carlyle ranks as vital in the great man and his power, *religious conviction*, — and by religion, he means, “ the thing a man does practically lay to heart, and know for certain ”; or again: “ the manner in which he feels himself to be spiritually related to the unseen world or no world.”<sup>1</sup>

Personality, then, is the key to Carlyle’s social philosophy, — a personality born a genius and developed by faithfulness in apprenticeship tasks, thus learning to guide others; — “ faithful over few things ” rewarded by being made “ ruler over many things.” The supreme need of every nation in every age according to him, is the willingness and the machinery for selecting as leaders the one born and trained to rule. And finding such he should be clothed with authority by the powers of earth, fortified with belief that this authority is also of God, so that he may be able to *compel* as well as merely *lead*.

In early times, such great men were heroes and worshipped as such, — and Carlyle would bring back that day, turning aside from all pretense of democracy for an aristocracy of the truly great.

#### WILLIAM JAMES (1842-1910)

##### *The Energies of Men*

Standing almost alone among the galaxy of great thinkers and writers whom we have passed in review, William James was a firm believer in *unconditioned* freedom of the will, at least in some small degree. His starting point for philosophical thought is the experience of life with all its contradictions; and unlike the

<sup>1</sup> *Heroes and Hero Worship*, p. 6, Lecture II.

absolutists in philosophy, whether materialistic or spiritualistic, he does not pretend to think through these contradictions and resolve them into an ultimate harmony.<sup>1</sup> For him, real freedom is a datum of experience hence a fact to be reckoned with in every attempt to interpret life in terms of thought.<sup>2</sup> The outcome of his philosophy is a "pluralistic universe"<sup>3</sup> on the one hand and "pragmatism" on the other; i. e., philosophy for him has no value except for life, no truth except as it is true to life, and no test of truth save the test of life,<sup>4</sup> and as thought cannot interpret all the facts of life in terms of unity it must use those of plurality.

From this point of view it is natural that he should criticize the monism of Spencer and the attempts of all strictly logical evolutionists to evolve the complexities of the universe as we know it and of life as we experience it, from one primordial principle whether matter, force, or matter-force.

Turning specifically to the subject of this chapter, James made a notable contribution in an article in the *Atlantic Monthly* in 1880 on "Great Men, Great Thoughts, and the Environment."<sup>5</sup> He proposes this problem: "What are the causes that make communities change from generation to generation, — that make the England of Queen Anne so different from the England of Elizabeth, the Harvard College of today so different from that of thirty years ago?" and answers, "The difference is due to the accumulated influences of individuals, of their examples, their initiatives, and their decisions." He sets his own solution over against that of Spencer and his followers who hold, according to James, that "the changes go on irrespective of persons, and are independent of individual control"; that "they are due to the environment, to the circumstances, the physical geography, the ancestral conditions, the increasing experience of outer relations, to everything, in fact, except the Grants, and the Bismarcks, the Joneses and the Smiths."<sup>6</sup>

<sup>1</sup> *Pragmatism*, pp. 20 f.

<sup>3</sup> *Pragmatism*, p. 161.

<sup>2</sup> *The Will to Believe*, p. 175.

<sup>4</sup> *Ibid.*, Lecture II.

<sup>5</sup> Reprinted in *The Will to Believe*, pp. 216 ff.

<sup>6</sup> John Fiske as a follower of Spencer repudiates this interpretation (*Excursions of an Evolutionist*, ch. VI), and quotes Spencer as saying that sociology "has in

James shows how impossible it is to find the causes of human variation either in heredity or in the environment, and holds that the deflecting cause which produces a genius instead of a dunce "must lie in a region so recondite and minute, must be such a ferment of a ferment, an infinitesimal of so high an order, that surmise itself may never succeed even in attempting to frame an image of it."<sup>1</sup> "The causes of production of great men," he continues, "lie in a sphere wholly inaccessible to the social philosopher. He must simply accept geniuses as data, just as Darwin accepts his spontaneous variations." For him, as for Darwin, the only problem is, these data being given, how does the environment affect them, and how do they affect the environment? "The mutations of societies . . . from generation to generation," he says, "are in the main due directly or indirectly to the acts or the example of individuals whose genius was so adapted to the receptivities of the moment, or whose accidental position of authority was so critical that they became ferments, initiators of movement, setters of precedent or fashion, centers of corruption, or destroyers of other persons, whose gifts, had they had free play, would have led society in another direction."<sup>2</sup>

From this quotation it is certain that James recognized the relativity of genius even as did Spencer, Fiske, Tarde, and Ward, but with this difference: with James, the work of the genius is relative to the receptivity of his group and age, with the others, the relativity of genius is due to the fact that he is the product of his group and age, though he may be so great a variation from the type as to warrant the appellation "sociological sport."<sup>3</sup>

every case for its subject-matter the growth, development, structure, and functions of the social aggregate, as brought about by the mutual actions of individuals, whose natures are partly like those of all men, partly like those of kindred races, partly distinctive." The fact remains, however, that the burden of Spencer's teaching is contrary to that of James. Cf. quotation from Spencer, *Will to Believe*, p. 232.

<sup>1</sup> *The Will to Believe*, p. 225.

<sup>2</sup> *Ibid.*, p. 227.

<sup>3</sup> Cf. Ward, *Pure Sociology*, pp. 243 ff. Lombroso held that the genius and the insane were but a step removed from each other. Galton showed by a study of many families that the genius was sometimes of sound family stock, but again related to a defective strain. Nordau and Sumner have distinguished between the genius who is a true leader in the line of advance, and the genius who is a degenerate although confining their discussion for the most part to the latter.

“Social evolution,” says James, “is a resultant of the interaction of two wholly distinct factors,—the individual, deriving his peculiar gifts from the play of physiological and intra-social forces, but bearing all the power of initiative and origination in his hands; and, second, the social environment, with its power of adopting or rejecting both him and his gifts. Both factors are essential to change. The community stagnates without the impulse of the individual. The impulse dies away without the sympathy of the community.”<sup>1</sup>

James has made another important contribution in his discussion of the inner source of power of individuals, under the caption, *The Energies of Men*.<sup>2</sup> His approach is through the familiar experience of “warming up” to a job, physical or intellectual, and especially through the experience of track athletes, who after reaching a point of fatigue push on by sheer force of will and tap a new level of energy, — a process known as “getting second wind.” “There may be layer after layer of this experience,” says James, “a third and a fourth wind may supervene.” “Mental activity,” he continues, “shows the phenomenon as well as physical, and in exceptional cases we may find, beyond the very extremity of fatigue distress, amounts of ease and power that we never dreamed ourselves to own, — sources of strength habitually not taxed at all, because habitually we never push through the obstructions, never pass those early critical points.”

James compares the phenomenon of “efficiency-equilibrium” with that of nutritive equilibrium and holds that “few men live at their maximum of energy, and second, that any one may be in vital equilibrium at very different rates of energizing.” This opens up an ethical and sociological problem of great importance. “In rough terms,” he says, “a man who energizes below his normal maximum fails by just so much to profit by his chance at life; and a nation filled with such men is inferior to a nation run at higher pressure. The problem is, then, how can men be trained up to their most useful pitch of energy? And how can nations make such training most accessible to all their sons and daughters?”

<sup>1</sup> *The Will to Believe*, p. 232.    <sup>2</sup> “The Energies of Men,” *Science*, March, 1907.

Two questions are raised in this connection, first, "What are the limits of human faculty in various directions ? and second, By what diversity of means, in the different types of human beings, may the faculties be stimulated to their best results ?"

Granting that as a rule men habitually use only a small part of the powers which they actually possess and which they might use under appropriate conditions, the question arises, "To what do the better men owe their escape ? and, in the fluctuations which all men feel in their own degree of energizing, to what are the improvements due, when they occur ?" — and he answers, "Either some unusual stimulus fills them with emotional excitement, or some unusual idea of necessity induces them to make an extra effort of will. Excitements, ideas, and efforts, in a word, are what carry us over the dam."

James illustrates his theory by several historical examples and points out especially the power of suggestive ideas to awaken the energies of loyalty, courage, endurance or devotion.

"Conversions," he holds, "whether they be political, scientific, philosophical, or religious, form another way in which bound energies are let loose. They unify us and put a stop to unscientific mental interferences. The result is freedom, and often a great enlargement of power. A belief that thus settles upon an individual always acts as a challenge to his will."

Christian Science, faith-cure and prayer are given credit for being instruments for the tapping of this reservoir of energy to the good of man, and he concludes: "The two questions, first that of the possible extent of our powers; and second, that of the various avenues of approach to them, the various keys for unlocking them in diverse individuals, dominate the whole problem of individual and national education. We need a topography of the limits of human power, similar to the chart which oculists use of the field of human vision. We need also a study of the various types of human beings with reference to the different ways in which their energy reserves may be appealed to and set loose. Biographies and individual experiences of every kind may be drawn upon for evidence here."<sup>1</sup>

<sup>1</sup> This James has done in his *Varieties of Religious Experience*.



James has thus contributed to our subject by holding that the relation of a man to his age and group is not wholly due to the fact that he is produced by it, but even more by the fact that rarely does a man have available energy to break away from the conventions that repress him and attain new heights, and further that though he himself gain a new vision of the true and good, the spread of this depends on the sympathy he may be able to secure in his social environment.

He shows further that certain emotional experiences and certain ideas have the power of tapping for man his ever-present reservoir of energy, or to change the figure of "carrying him over the dam." The true genius is the man who by heredity or by some inner power is able to attain levels of efficiency-energy far beyond those of the average of his group and inspire his fellow-men to like attainment. Such a man is an example, an exponent, and leader in active spiritual adaptation.

EDWARD ALSWORTH ROSS (1866- )

*The Psychology of Social Control*

Professor Ross has made contributions to our subject primarily along two lines: first, in his criticism of the theories of other sociologists and second in his constructive analysis of social control.

As a sociological critic he is perhaps without a peer among American scholars in this field; yet brilliant and suggestive as are these criticisms he seems to lack the ability to "see life steadily and see it whole," hence the many apparent inconsistencies in his writings.

As many of his criticisms have already been cited, and the rest are easily accessible in his *Foundations of Sociology*, we will consider here merely his distinction between change, adaptation and progress, and then discuss his analysis of social control.

Although Professor Ross denies any place to the term progress in social science,<sup>1</sup> he makes large use of it in his *Social Psychology* and *Social Control*, and defines it, now in terms of adaptation, as where he says "Progress follows the line of advantage, substituting always the better adapted,"<sup>2</sup> but again in terms of mere

<sup>1</sup> *Foundations of Sociology*, pp. 75, 76.

<sup>2</sup> *Social Psychology*, p. 94.

change as in the following: "The accumulation of changes in the rational principle is *progress*; of utilities, *practical* progress; of truths, *intellectual* progress. Moral progress and aesthetic progress do not come about essentially by origination and rational diffusion. Progress in these departments is usually the consequence of material or intellectual advancement."<sup>1</sup>

In his *Foundations of Sociology* he differentiates progress, change and adaptation as follows: "Change means any qualitative variation, whereas progress means amelioration, perfectionment. The one is movement; the other is movement in the direction of advantage. Progress is better adaptation to given conditions. Change may be adaptation, — at first, perhaps, very imperfect, — to new conditions." The difference is illustrated as follows: "When a mammal thrust northward gets a heavier coat of hair, or a bird acquires the nest-building instinct with the advent of a rodent that destroys her eggs on the ground, we have a case of adaptation. Now, this way of interpreting change is becoming ever more helpful to the student of society. . . . Movements that seem regressive are equally ambiguous. Militarism is hardly a regress when a people finds itself menaced by the approach of an aggressive neighbor. . . . The growth of one-man power is degeneration if it is caused by a lowered citizenship; it is only adaptation if the facilities for focusing public opinion have so improved that the cruder checks on the executive have ceased to be necessary. I conclude, then, that social dynamics ought to drop such vague and dubious conceptions as *progress* and *regress*, and address itself to the simple fact of *social change*."<sup>2</sup>

Now progress as used in these and other examples is defined very much as we have defined adaptation, and adaptation, he says, is becoming ever more helpful as a way of interpreting change. Indeed in none of these examples is there any necessary distinction.

We find that he uses adaptation in a way that would seem to make it the standard of progress in his discussion of "the genesis and evolution of ethical elements"<sup>3</sup> where he holds that something very like the struggle and survival principle of biological

<sup>1</sup> *Social Psychology*, p. 286. <sup>2</sup> *Foundations*, pp. 185-189. <sup>3</sup> *Social Control*, ch. XXV.

evolution is at work in society, and that in the struggle among "views," "customs," "methods" and "civilizations" some perish while others survive. "The genesis of ethical elements," he says, "as well as the genesis of customs and beliefs, is a process of selection and survival. Just as the development of Zuni or Lydian pottery is due to a competition which makes the handiest and handsomest form of pot the prevailing type, and to the renewal of this healthy competition whenever an inventive potter or a foreign art supplies a new pattern, so the improvement in the ethical standard of a civilization is due to the survival and ascendancy of those elements which are best adapted to an orderly social life. . . . It is just this selection which explains the snug fit of early ethical elements to the needs of the group that develop them." In this same connection he shows how certain conventions "develop very naturally by a process of *unconscious adaptation* out of the mental contacts and long intercourse of associates." <sup>1</sup>

This doctrine of adaptation as a theory of social progress seems to be the one thing lacking to make clear his interpretation of the "Vicissitudes of Social Control," <sup>2</sup> where he shows how *change in control* is brought about by *change in social need* due largely to change in the economic condition of the people. In other words *the vicissitudes of social control are due to society's need of adapting itself to changed conditions of existence.*

There seem to be some features of social progress which, according to Ross, make the biological categories of struggle and survival, or the principle of adaptation, inapplicable. Commenting on the struggle between civilizations, he says, "This struggle of rival elements of culture is by no means the same thing as the struggle between persons. When one race has overrun and trampled down another, it is always interesting to see if the spiritual contest of the two civilizations has the same issue as the physical contest of the two races. Will the upper civilization smother the lower, as in the case of the Spaniards and the Aztecs, the Germans and the Wends, the Romans and the Etruscans, the Saracens and the Roman Africans; or will the one beneath grow

<sup>1</sup> *Social Control*, pp. 342-345.

<sup>2</sup> *Ibid.*, ch. XXIX.

up through and subdue the one above, as the Romans were captivated by the Greek culture, the barbarians by Roman civilization, or the Mongols by Islam?"<sup>1</sup> This is a strong criticism of the neo-Darwinian sociologists and militates against the rigid use of the biological doctrine of selection applied to social progress but it does not militate against the use of the doctrine of *adaptation* or *adjustment*, for a new amalgam of cultures is the net result of a multitude of minor struggles, and the new political unit faces the problem of survival through adaptation. Ross seems to recognize this for he says: "The struggle between groups of men involves a testing of the codes and moralities that govern them, and must in the long run conduce to the triumph of those codes and moralities *which strengthen the group over those which do not.*" In this statement we have an approach to the application of group struggle and survival emphasized by the neo-Darwinian sociologists.

As a constructive sociologist Ross may well be classed as an "eclectic" because of the wide use he has made of the discoveries and formulations of others in the same field. He has also formulated many new laws but it is difficult to enumerate those due to him alone.

His most important contribution to our subject along positive lines is to be found in his *Social Control*. In this he discusses the functions of natural control in securing order and progress under the four headings of "sympathy," "sociability," "sense of justice," and "individual reaction." The rôle of each is presented in strong terms, but each and all together are found unequal to the task of securing social order and progress.

This is followed by a consideration of the "need," "direction," and "radiant points" of social control. In Part II we are presented with an able survey of the "means of control" such as public opinion, law, belief, social suggestion including education and custom, social religion, personal ideals, ceremony, art, personality, enlightenment and illusion. With the exception of law and personal ideals these forces for the most part act in such a way as to make it possible to classify the process by which

<sup>1</sup> *Social Control*, p. 340.

society is thus moulded, under passive adaptation. In law and consciously directed public opinion we have "social telesis"; in personal ideals, art, personality, enlightenment and social religion, we have "individual telesis" yet working for social control through suggestion and imitation in which the passive element predominates.

In considering the "genesis of ethical elements," variations in the discovery and enunciation of moral truths are held to be due to the prophet or moral genius owing to his superior social insight,<sup>1</sup> and the successful promulgation of these truths, to the élite. But variations having been accounted for in this way through "innovation," the ultimate triumph of the principle is held to be due to struggle and survival, the decisive factor being social utility.<sup>2</sup>

In his discussion of "the system of control" we have an analysis of the functions and methods of control as exercised in organized government. First to be considered is *class control* which is defined as "the exercise of power by a parasitic class in its own interest,"—as in the case of slavery and serfdom. Under class control private property develops and "is so shaped as to permit a slanting exploitation under which a class is able to live in idleness by monopolizing land or other indispensable natural means of production." The system of class control is modified "to economize coercion, to economize supervision, to economize direction."<sup>3</sup> As the parasitic class in control cannot easily bolster up their authority by use of art, personality and social religion, which emanate from the great man, the prophet or the élite, use is made of *force, superstition, fraud, pomp and prescription* which are degenerate forms of those natural supports of social order already considered, viz., law, belief in the supernatural, custom, ceremony and illusion.<sup>4</sup> "Born in aggression and perfected in exploitation," Ross says, "the State even now, when it is more and more directed by the common will, is not easy to keep from slipping back into the rut it wore for itself during the centuries it was the engine of a parasitic class."<sup>5</sup>

<sup>1</sup> *Social Control*, p. 357.

<sup>2</sup> *Ibid.*, pp. 376, 377.

<sup>3</sup> *Ibid.*, p. 386.

<sup>2</sup> *Ibid.*, pp. 342, 349, 357.

<sup>4</sup> *Ibid.*, pp. 381, 382, 386 f.

Social control is distinguished from class control by the fact that in the latter case society being on the competitive basis, "the hopelessly poor and wretched are, to a large extent, the weak and incompetent who have accumulated at the lower end of the social scale, because they or their parents have failed to meet the tests of the competitive system." In this case control is largely in the hands of the efficient and in the interest of the social whole.

Ross assumes in the above that the present competitive system is a success in producing social segregation on the basis of native ability and social worth, — a questionable assumption.

The vicissitudes of social control, he points out, are primarily in response to social needs, and of these the economic are considered of first importance.<sup>1</sup> Conflict of groups and conflict of classes within the group are also recognized as potent causes of change, the class conflict being due not alone to *sharp conflict of interest* but to *great contrast of means and a great inequality of opportunity*.<sup>2</sup> "Another cause of vicissitude," he says, "is *change in the culture and habits of a people*" whether due to fresh knowledge, new ideas, foreign influences, or novel experiences.<sup>3</sup>

Ross divides the supports of order into two groups, the *ethical*, including public opinion, suggestion, personal ideals, social religion, art, and social valuations based on sentiment rather than judgment of social utility, and the *political*, including law, belief, ceremony, education and illusion, — the last, "frequently the means deliberately chosen in order to reach certain ends."<sup>4</sup> The political supports are instruments of the ethical.

He believes that social control by the hero, by custom, by supernatural religion, and by mob, ban or boycott, is passing, and that enlightened self-interest, suggestion, moral idealism and social religion will become increasingly potent.<sup>5</sup>

In discussing the limits of social control he takes a decided stand against all social theories that place the good of the group above that of its constituent members, holding that "society is not a being, but just people in their collective capacity," and

<sup>1</sup> *Social Control*, p. 395.

<sup>2</sup> *Ibid.*, p. 402.

<sup>3</sup> *Ibid.*, p. 404.

<sup>4</sup> *Ibid.*, p. 411.

<sup>5</sup> *Ibid.*, pp. 415-416.

“that the only welfare there is, is the welfare of persons present or to come.”<sup>1</sup>

Ross formulates the following canons as to the limits of social control:<sup>2</sup>—

1. Each increment of social interference should bring more benefit to persons as members of society than it entails inconvenience to persons as individuals.

2. Social interference should not lightly excite against itself the passion for liberty.

3. Social interference should respect the sentiments that are the support of natural order.

4. Social interference should not be so paternal as to check the self-extinction of the morally ill-constituted.

5. Social interference should not so limit the struggle for existence as to nullify the selective process.

The criteria of social control are *economy*, *inwardness* (reaching the feelings, reason and will), *simplicity*, and *spontaneity*, fostered by *diffusion*, — as in public opinion, suggestion, social religion and art.

His conclusion harmonizes his theory of social control with the position we are advocating:—

The better adaptation of animals to one another appears to be brought about by accumulated changes in body and brain. The better adaptation of men to one another is brought about, not only in this way, but also by the improvement of the instruments that constitute the apparatus of social control. In the same way that the improvement of optical instruments checks the evolution of the eye, and the improvement of tools checks the evolution of the hand, the improvement of instruments of control checks the evolution of the social instincts. The goal of social development is not, as some imagine, a perfect love, or a perfect conscience, but *better adaptation*; and the more this is artificial, the less need it be natural.<sup>3</sup>

Ross does not believe that any one form of control is adapted to all races and temperaments, but that under the influence of social forces, the form of control best suited to a people is the one selected, and that those in authority should study and use these means of control though, as in the case of supernatural religion, they may rest on illusion.<sup>4</sup>

<sup>1</sup> *Social Control*, p. 418.

<sup>2</sup> *Ibid.*, pp. 419 f.

<sup>3</sup> *Ibid.*, p. 437.

<sup>4</sup> *Ibid.*, p. 441.

## CHAPTER XVI

### IDEALIZATION AND RELIGION

WE have already noted to some extent the influence of these factors in the various social theories passed in review, but have reserved till this later chapter a more complete analysis of the process of idealization in accordance with the principle of adaptation. This process may be interpreted in terms of "active moral adaptation" leading to "active social adaptation" and finally to "religious adaptation."

Idealization as a factor in social progress has three elements: (1) the intellectual by which the ideal is created, i. e., imagination, (2) the emotional response of the individual by way of attraction, and (3) the volitional expression of thought and feeling in art, religion and rational conduct. In the latter case, where the individual endeavors to harmonize his life with his ideal, we have a form of adaptation that may be termed *active moral*, and growing out of this is a fourth element, — the desire and effort to bring others to accept the ideal which dominates our life, due to the demand of our whole nature for internal harmony, and adjustment with our spiritual environment. Normal man can never be satisfied to live in solitude, even in his thought life, nor can he be satisfied to live in conflict.<sup>1</sup> John Wesley was wise when he urged his missionaries as they started for America to "find companions or make them." If man cannot find or make companions in the flesh he seeks them in the spiritual realm, either as revealed in their writings or as created by his imagination.

<sup>1</sup> Social mal-adaptation not only does violence to our egoistic and social interests and instincts and hence leads to dissatisfaction and an endeavor to secure adjustment, but it causes intellectual conflicts and the tendency of the mind is to secure harmony. The resolution of conflict is always pleasure-giving. Cf. Bradley, *Appearance and Reality*, ch. XIV; also Comte, *A General View*, pp. 387 f.



## IDEALIZATION AND RELIGION ACCORDING TO COMTE

The process of idealization issuing in religion was recognized and valued in the *Positive Philosophy* but not analyzed and developed as it was later in the *Polity* when Comte had come to rate the feelings more highly than the intellect, the beautifying of life above material achievement, and had come to worship woman because she was the highest expression of this phase of life.<sup>1</sup>

The idealizing activity of man finds expression, according to Comte in art in its various forms of poetry, oratory, music, painting and sculpture, and in religion. Art is defined as "an ideal representation of facts" and its object held to be "to cultivate our sense of perfection." In art, he holds, the unity of human nature finds its most complete and most natural representation, for it is in direct relation with the three orders of phenomena by which human nature is characterized. It originates in feeling, has its basis in thought, and its end in action, hence its power of exerting an influence for good alike on every phase of our existence, whether personal or social. Thus art, standing midway between philosophy and polity, should be controlled by the former, as the emotions, unguided, express themselves in extravagant and sometimes harmful ways. Art in turn should influence polity, since "in every operation that man undertakes, he must imagine before he executes."

Philosophy and art must work together in the formation of social Utopias, art to form the ideal and philosophy to see that this ideal is related to the real. "As humanity is subject to the order of the external world," he says, "the ideal must always be subordinated to the real."<sup>2</sup> . . . In our artificial improvements we should never aim at anything more than a wise modification of the natural order; we should never attempt to subvert it."<sup>3</sup>

Art of various kinds is a factor in progress, he holds, because it

<sup>1</sup> *A General View*, chs. V and VI.

<sup>2</sup> *Ibid.*, p. 316. He shows how this truth is illustrated in the developing mind of the child: "As his notions of fact change, his fictions are modified in conformity with these changes."

<sup>3</sup> *Ibid.*, p. 319.

has to do chiefly with the feelings. "Of all the phenomena which relate to man human affections are the most modifiable and therefore the most susceptible of idealization. Being more perfect than any other, by virtue of their higher complexity, they allow greater scope for improvement. . . . All aesthetic study . . . may become a useful moral exercise, by calling sympathies and antipathies into healthy play. The effect is far greater when the representation, passing the limits of strict accuracy, is suitably idealized. This, indeed, is the characteristic mission of art. Its function is to construct types of the noblest kind by the contemplation of which our feelings and thoughts may be elevated." <sup>1</sup>

There are three stages in the aesthetic process, imitation, idealization and expression. Poetry is the art which idealizes the most and imitates the least. The function of the poet is esteemed because of his power to idealize and to stimulate.<sup>2</sup>

As to the relation of art to social progress our author says: "Utopias are to the art of social life what geometrical and mechanical types are to their respective arts. In these their necessity is universally recognized; and surely the necessity cannot be less in problems of such far greater intricacy. Accordingly we see that, notwithstanding the empirical condition in which political art has hitherto existed, every great change has been ushered in, one or two centuries beforehand, by an Utopia bearing some analogy to it. It was the product of the aesthetic genius of Humanity working under an imperfect sense of its conditions and requirements." <sup>3</sup>

The function of art in education, in the propagation of positivism, in government and religion is discussed at some length, and he concludes "that the priest of Humanity will not have attained his full measure of superiority over the priest of God, until, with the intellect of the philosopher, he combines the enthusiasm of the poet, as well as the tenderness of woman and the people's energy." <sup>4</sup>

<sup>1</sup> *A General View*, p. 315.

<sup>2</sup> *Ibid.*, p. 325. Compare the teaching of Buckle who ignores this function of literature and art, — *supra*, ch. VI.

<sup>3</sup> *Ibid.*, p. 317.

<sup>4</sup> *Ibid.*, p. 354.

The process of idealization, directed by social utility, eventuates in the worship of Humanity. "Towards Humanity, who is for us the only true Great Being, we, the conscious elements of whom she<sup>1</sup> is composed, shall henceforth direct every aspect of our life, individual or collective. Our thoughts will be devoted to the knowledge of Humanity, our affections to her love, our actions to her service."<sup>2</sup>

The principle of adaptation is clearly manifested in this discussion for not only is the development of art dependent on social utility,<sup>3</sup> but its influence is based on the doctrine of relativity or "adaptability." The ideal must spring out of the real and inspire men to transform the real, *gradually*, in the line of perfectionment.

The ideal of humanity as a Great Being is a fiction of the mind, according to Comte, but though an illusion is in a sense true because this fiction and religious worship connected with it, are necessary to progress.

#### IDEALIZATION AND RELIGION ACCORDING TO ROSS

Idealization according to Ross is the product of self-esteem reacting reflectively in accordance with our mental and temperamental make-up. The process is both personal and social. Society, by a process of utility and selection, evolves certain "types" of character and conduct. The individual accepts these, with modification, as his *personal ideals*. The social type is always above the average man so that "it is able to lift him once he comes to live it and lay hold on it."<sup>4</sup>

Ross shows how each social class and calling has its type or ideal, in each case developed by the principle of adaptation, as for example, contempt of danger in the soldier type, harshness in the jailor, tenderness in the nurse; and how these types are magnified and glorified by literature, oratory, art and religion thus

<sup>1</sup> Feminine because the Great Being is a personification of those qualities that find their highest expression in woman.

<sup>2</sup> *A General View*, p. 365.

<sup>3</sup> *Ibid.*, p. 325.

<sup>4</sup> *Social Control*, p. 220.

making a strong appeal to the individual who desires social esteem and dreads the shame of social disapproval.<sup>1</sup> Types complete in every feature, however, are provided only for the chief positions in life. For the rest, society by dissecting and comparing normal conduct for all sorts of exigencies brings to light certain resemblances; but each individual has to work out for himself his own personal ideal.

The generalized types formulated by society by a process of passive adjustment furnish the background for conventional ethics; the personal acceptance of and reaction on these generalized types furnish the highest form of reflective ethics.<sup>2</sup> "The greatest effect of an ideal," says Ross, "is not attained when it is pitched very far above natural inclination," — otherwise it will attract such a slender portion of the whole area of variation that it will benefit very few people; yet on the other hand too low a standard may do no good by not being far enough above the average to raise it.<sup>3</sup>

Idealization, according to our author, is a powerful means of control and at present has more promise than any of its rivals, — though not a final form. "Social order will have to rest on artifice till there is joined to natural altruism, as we find it developing in the family, a clearness of vision that sees in the upright discharge of the requirements of every social office and station the highest ministry to the welfare of our fellows."<sup>4</sup> He does not show how this vision is to be secured, however, — for this vision itself needs to be interpreted in terms of adaptation.

Art, according to Ross, as with Comte, is the means of expressing ideals. It functions in social progress by arousing the passions, by kindling sympathy, by exploiting the aesthetic sense and the sense of the sublime, by perfecting social symbols and by fascinating with new types. It performs one of its greatest functions in transmuting realities and in veiling with some attractive image the grisly features of hardship, mutilation, and death, especially in its glorification of war and sacrifice when these are needed. Art softens inevitable ills, persuades to present hardship

<sup>1</sup> *Social Control*, p. 235.

<sup>2</sup> *Ibid.*, p. 242.

<sup>3</sup> *Ibid.*, p. 243.

<sup>4</sup> *Ibid.*, p. 246.

for the sake of future gain and lures man to the supremest sacrifices for the sake not of self, but of society at large.<sup>1</sup>

Closely related to idealization is illusion, — a device evolved to control those who cannot be controlled by other devices, such as the illusion of *pseudo-consequences* exploited in Sunday-school literature; that of *social solidarity* which has no real basis of appeal to the individual, and that of *asceticism*, — a symptom of bad race temperament, depressing climate, low physical tone, or the resource of a class desiring power. Another illusion is that of the dicta of intuitionist rather than social moralists who are interested in abstract duty rather than in social welfare.<sup>2</sup>

Ross' use of the term illusion in some of these cases at least is questionable. All are inductions from experience, perhaps exaggerated or mixed with error, or generalizations that are not applicable in every individual case.

*Social valuations* and the *genesis of ethical elements* are next discussed and large use is made of the principle of adaptation, some of these valuations being derived from race experience, others being the creation of genius. "The improvement in the ethical standard of a civilization," he says, "is due to the survival and ascendancy of those elements which are *best adapted to an orderly social life*."<sup>3</sup> The principle of selection, he holds, explains only the rise of the ethos of the clan. "We need invention to explain the rise of a national or race ethos."<sup>4</sup> In this distinction we have a contrast between passive and active adaptation.

Ross' discussion of religion is unsatisfactory because unclear if not contradictory. In one place he seems to accept the reality of mysticism from which springs legal religion,<sup>5</sup> but in other places this is held to be an illusion though necessary,<sup>6</sup> while the only true religion is held to be social idealism based on sympathy, — very like Comte's *Religion of Humanity*.<sup>7</sup> This *social religion* is defined as "the conviction that there is a bond of ideal relationship between the members of a society and the feelings that arise in consequence of this connection." In one place he seems to

<sup>1</sup> *Social Control*, pp. 264 f.

<sup>2</sup> *Ibid.*, ch. XXIII.

<sup>3</sup> *Ibid.*, p. 342.

<sup>4</sup> *Ibid.*, p. 350.

<sup>5</sup> *Ibid.*, pp. 197, 207, 216.

<sup>6</sup> *Ibid.*, pp. 209, 212, 441.

<sup>7</sup> *Ibid.*, ch. XVI.

accept the interpretation of religion as given by Jesus,<sup>1</sup> but again turns aside from all super-naturalism although apparently he rejects the religion of naturalism.<sup>2</sup>

On the whole Ross seems to consider religion to be an idealization of social relations and experiences, and one of the most potent factors in securing both order and progress. "A body of religious belief of the kind I have described [the faith that makes for ethical religion]", he says, "is a storage battery of moral emotion. It is a means of storing up for society the moral energy of the ethical élite, and enabling it to do work by producing sociable emotions and modifying conduct in desirable ways."<sup>3</sup>

Comparing the value of social religion with other means of social control he says: "The palm must always belong to that influence which goes to the root of man's badness, and by giving him more interests and sympathies converts a narrow self into a broad self."<sup>4</sup> He concludes that "social religion has a long and possibly a great career awaiting it." "As it disengages itself from that which is transient and perishable," he continues, "as the dross is purged away from its beliefs and the element of social compulsion entirely disappears from it, social religion will become purer and nobler. No longer a paid ally of the policeman, no longer a pillar of social order, it will take its unquestioned place with art, and science, and wisdom, as one of the free manifestations of the higher human spirit."

#### IDEALIZATION AND RELIGION ACCORDING TO BALDWIN

Professor Baldwin's *Social and Ethical Interpretations*<sup>5</sup> so abounds in material bearing on this phase of our subject that selection or a brief summary is difficult.

The imagination, according to our author, is not merely constructive in its activity but "creative" for the products of its activity are "new forms into which the materials of our thought are cast as a result of variations in our actions in the process of

<sup>1</sup> *Social Control*, pp. 204 f.

<sup>2</sup> *Ibid.*, p. 213. The Religion of Naturalism is not given the best possible interpretation.

<sup>3</sup> *Ibid.*, p. 212.

<sup>4</sup> *Ibid.*, p. 216.

<sup>5</sup> Also his *Individual and Society*.

adaptation to the ends of utility." "It is by adapted action," he continues, "that our mental life is held together in great consistent thought-systems; and it is by new refinements upon these adapted and correlated actions that new variations are introduced into the systems of our coherent thought."<sup>1</sup> Thus the truth is that thought is a function of doing as well as the reverse, that "what we do is always a function of what we think,"<sup>2</sup> and the thought that is eventually incorporated into our thought-system is the result of activity that has proven of adaptive value.

The idealizing as well as constructive function of the imagination is prominent in the dialectic of growth in the developing child, and in this process several "selves" emerge in consciousness: (1) the *habitual self* consisting of a "solidified mass of personal material which he has worked into a systematic whole by a series of acts";<sup>3</sup> (2) the *accommodating self*, still in the "projective," unfinished stage "that is constantly being modified by the influences outside, and in turn, passing the new things learned over to the self of habit,—the self that learns, that imitates, that accommodates to new suggestions"; (3) an *ethical self* gradually emerging partly by obedience and partly by suggestion, built up as a result of contact with father, mother, nurse, and others, whose actions he cannot interpret but whom he must obey, and who, he comes to learn, in turn obey a common law; (4) an *ideal self* "which represents his best accommodation to self in general," and (5) a *public self* the basis of the ideal self.<sup>4</sup>

Having described the process by which the ideal self arises in consciousness,<sup>5</sup> Baldwin says, "The regular, law-abiding, sanction-bringing, duty-observing self hovers over his thought, inspires it and regulates its tendencies to action." "This general notion of self," he continues, "is, like all general notions considered as general, not a presentation, not a mental content, but an attitude, a way of acting; and the child has to bring all the partial personal tendencies to action which spring up on the

<sup>1</sup> *Social and Ethical Interpretations*, p. 94.

<sup>2</sup> *Ibid.*, pp. 92, 97.

<sup>3</sup> *Ibid.*, p. 34.

<sup>4</sup> *Ibid.*, pp. 283, 284, 315.

<sup>5</sup> *Ibid.*, pp. 36 f.

thought of the partial more isolated selves of his habit, into the way of action which we call ethical conduct.”<sup>1</sup>

The concrete body of this ideal, that is, the child's actual mental picture of what is good in a person, is made up from his own acts and the acts which he conceives as possibly his own. “And then, so far as he feels it to be inadequate, he seeks to find, in the persons projective to him some one or more whose actions are better than his.”

Ethical conduct has one aspect which our author calls sentiment and defines as “the emotional or active tendency of consciousness away beyond the confines of its actual interpretations.”<sup>1</sup> This general sentiment has three phases the *ethical*, *social*, and *religious*, which are of special importance in our present discussion.

“The most general and important phase of ethical sentiment,” he says, “is that known in theoretical ethics as the sense of obligation.” This arises, he shows, from a sense of incompleteness, of *mal-adaptation*, of social restraint compelling obedience to a law higher than any worked out by himself.<sup>2</sup> When the child has attained an appreciation of right conduct he “ejects” this into his associates,<sup>3</sup> and by the dialectics of personal and social growth there is worked out a general public opinion.

By social or public sentiment is meant that pressure of social suggestion and constraint on the individual of which the child, — and all persons, — are more or less conscious much of the time, this sentiment growing out of the conflicts between the habitual self and the public self.<sup>4</sup> This public sentiment as felt and given intellectual form, becomes ethical judgment. The child judges and realizes that he is judged, — another dialectic process.<sup>5</sup>

The religious sentiment of the growing child is merely an extension of the ethical and social,<sup>6</sup> and has two elements, a *feeling of dependence* with three phases, *spontaneous*, *intellectual* and *ethical*, and a *feeling of mystery* engendered as a result of his ever increasing experience of the unexpected and inexplicable in his relations with persons.<sup>7</sup>

<sup>1</sup> *Social and Ethical Interpretations*, p. 295.

<sup>2</sup> *Ibid.*, pp. 36, 297.

<sup>3</sup> *Ibid.*, pp. 299, 331; cf. *The Individual and Society*, p. 72.

<sup>4</sup> *Social and Ethical Interpretations*, p. 315.

<sup>5</sup> *Ibid.*, p. 326.

<sup>6</sup> *Ibid.*, p. 441.

<sup>7</sup> *Ibid.*, pp. 347 f.



The developing sense of dependence in its intellectual phase gives rise to the two categories of cause and design<sup>1</sup> which enter as elements into the construction of his ideal of the *great spirit*; in its ethical phase it gives rise to such attributes of Deity as justice, mercy, grace, love and righteousness. This sense of dependence further explains the essential anthropomorphism of the religious consciousness.<sup>2</sup>

There are two elements in the "personal sense" as revealed in this anthropomorphism: "(1) There is the tendency to make ejective the ideal person reached by the road already traced; to make it real, a separate being or personality. There must be somewhere, feels the child, a self which answers to all the elements of the law: to the charity, the love, the beauty of the ideal, whose presence in my thought makes my own self morally so incomplete. . . . The *great spirit* becomes the way of speaking of this being, — that is, it is the race-child's way. (2) The other element in religious emotion is the child's expectation of yet more manifestations from this highest of all persons, — manifestations which he cannot anticipate nor cope with; which he must submit to when they come, learn of only when they have come, propitiate in the ways that please persons, and stand in awe of from first to last."<sup>3</sup>

"The ejective, personifying element, which the history of primitive peoples puts so clearly in evidence," our author continues, "gives positive content to the religious sentiment as mentioned above; while the projective or negative element, as seen thus in this latter aspect of the child's growth, is the awe-inspiring, something-over of mystery equally emphasized in the rites and cults of primitive ceremonial."<sup>4</sup>

This developing sense of mystery in the dialectic of personal growth is analyzed as follows: —

*First. The ethical child, — and man too, — must think of God as thinking of him; as having a positive ethical attitude toward him. . . .*

*Second. In this highest stretch, therefore, of the religious life into which the child is now entering, God is a real person, standing in real relations of*

<sup>1</sup> *Social and Ethical Interpretations*, p. 337; also to those of "omnipotence and omnipresence," p. 346.

<sup>2</sup> *Ibid.*, p. 346.

<sup>3</sup> *Ibid.*, pp. 330, 331.

<sup>4</sup> *Ibid.*, p. 331.

*approval and disapproval*, — says the religious sense, — *to me who worship him*. . . .

The divine person is, in the religious life, very much the same sort of a postulate that the social fellow is in the ethical life, and that the world of external and personal relationships is in the intellectual life.

*Third.* *The intelligence is baffled both by the limitations of its own growth and by the very "projective" and "prospective" nature of the movement upon which the religious sense rests.* . . .

*Fourth.* *The essential mysticism of the religious consciousness lives to the last.*<sup>1</sup>

Our author concludes his discussion as follows: "The place of religion in social development is, in view of its dependence upon the growth of self at all its stages, that of emotion of the social sort. It becomes most important in its alliance with the ethical life in the higher reaches of human development."<sup>2</sup>

Thus out of the activities, the conflicts and the relationships of life evolves in the child and in the race, by the dialectic of personal growth, *reverence for ideal personality*.

Professor Baldwin's analysis of the dialectic of personal growth issuing in reverence for personality is most suggestive and helpful, but there are other processes of idealization issuing in so-called religion which his analysis does not cover. He lays stress on the *esprit de corps*<sup>3</sup> to be found in certain groups and on the social instincts that give rise to the social self but he has not analyzed the expansion of self-consciousness to include a group so satisfactorily as has McDougall for example. The truth seems to be that whereas empirical self-consciousness is clarified and intensified by conflict with nature and with other individuals, social self-consciousness, i. e., self-feeling that includes a group, develops through co-operation with other selves united by common interests and by conflicts with other groups.

In proportion as *esprit de corps* is developed and enthusiastic effort put forth for the success of the group; in proportion as the members have *faith* in the organization or institution and in the ideal for which it exists; in proportion as they *love* and *serve* it, sometimes being willing even to die for it, a phenomenon results that has some warrant to be called "social religion." This was

<sup>1</sup> *Social and Ethical Interpretations*, p. 355 (italics in text).

<sup>2</sup> *Ibid.*, p. 357.

<sup>3</sup> *Ibid.*, pp. 232, 407 f.

Comte's attitude toward humanity idealized and personified as the "Great Being." Such is the attitude of many toward socialism. There is a third phenomenon that is frequently called religion, namely a worshipful attitude toward the cosmos. A sense of mystery and power above and beyond the highest reach of intellect or of experience evokes the negative self-feeling with a sense of dependence, submission, and obedience. With feeling dominant the result is mysticism; with the intellect dominant we are apt to have some form of religious monism, i. e., an attitude of belief and trust in the Eternal Source of Power. Now as the process of the evolving self-consciousness on the one hand and of the expanding self-consciousness or self-feeling on the other are not distinct processes but essentially one with two aspects, and as the processes of idealization growing out of them are valid for life activity, so the religious culmination of each may be considered as true. We need a reverence for personality, individual and transcendental, as we have in theism; we need also reverence for personality as incarnate in our fellow-men and as approached in the unity and power of intelligent social endeavor.

In the chapter on biological evolution we noted the value of the doctrine of adaptation in explaining the origin of consciousness and the development of the instincts (including the social) and of the higher intellectual qualities of man. In our discussion of the transition from passive to active adaptation we considered this same question further with the addition of new material, especially the importance of "prolongation of infancy" in enabling the individual to become adjusted to his spiritual environment. We have seen how Baldwin has endeavored to explain the development of idealization and religion by the "dialectic of personal growth," and have discussed the function of these two factors through the writings of several authors, especially Comte and Ross. The sum of the whole matter seems to be that beginning historically in the personification of the forces of nature as in animism, the process of idealization has culminated now in the personification and worship of the social ideal as with Comte, now in the personification and worship of the cosmic process itself

as in the spiritualistic monism of Fiske, but again in belief in and worship of the first cause considered to be a self-conscious personality, as with Baldwin.

Idealization must by its very nature be accompanied by some sort of emotional experience and a volitional tendency to satisfy the interest through which, alone, the process could have been initiated and carried to completion; i. e., the ideal is formed in response to felt need. It grows out of the experience of mal-adjustment with the spiritual (including social) environment, and is a force drawing the individual into assimilation with the ideal life of interest and desire. The mal-adjustments which lead to the formation of ideals are manifold, arising chiefly from the fact that the individual has many conflicting interests within his own personal life (as between the desire to satisfy hunger and the desire for intellectual or aesthetic enjoyment), and from the fact, also, that he is a member of various social unities with conflicting "mores" and conflicting ideals. But this very conflict of ideals and interests, is, as we have seen, the condition of development. As friction between the wheels and track is necessary for progress by the locomotive; as consciousness itself is born out of the friction developed in the process of personal growth,<sup>1</sup> so the higher reaches of intellectual and moral power are the outcome of conflicts won in struggles on the lower planes of living. This leads us to formulate the law that mal-adaptation on the lower planes of life is essential to progress to a higher plane. To use another illustration: as biological progress is marked by the development of "inhibitors" or factors that control or prevent the functioning of other factors or "characters,"<sup>1</sup> so social and moral evolution is marked by the development of *self-control*, and self-control, both individual and social, is secured only by the *experience of conflict and victory*, — of *mal-adaptation leading to a higher form of adaptation*.<sup>2</sup>

<sup>1</sup> Sabatier, *Outlines of a Philosophy of Religion*, p. 15.

<sup>2</sup> Professor C. B. Davenport would seem to make self-control wholly a matter of the presence of "inhibitors" in the germ plasm which under normal conditions come to expression and prevent anti-social conduct. In a letter to the author he says, "In the development of the child, the inhibitors develop one after the other in those who are self-controlled and fail of development in those who lack self-control";

To conclude this present discussion: Man must adapt himself to his physical environment and adapt it to his needs. Out of this problem and process arises the necessity of adapting himself to his social environment and in the case of the cultured man of influencing others for the purpose of satisfying his manifold personal interests (or needs). But among these needs are some that are social, intellectual, aesthetic, moral and religious, and the satisfaction of these demands co-operation with his fellow-men rather than exploitation. Thus the self develops both *intensively and extensively*, each experience of mal-adaptation making possible a higher form of adaptation culminating, as we have seen, in the formation of the *personal ideal*, the *group quasi-personal ideal*, and the *cosmic or divine ideal*.

The process of adjusting oneself progressively to the ever-enlarging personal and group ideal is a phase of spiritual adaptation which might be called *moral adaptation*, and if the personal and group ideal is given religious sanction, i. e., if the intellectual form is supported by belief in and adoration of an *objective correlate* of the ideal, and the individual endeavors to conform his life to that ideal we have *religious adaptation*.

Is there another phase of the religious life and thought which corresponds to active material and active social adaptation in the sense of a manipulation of the ontological correlate of the personal religious ideal in the interest of self-satisfaction? In other words, instead of conceiving of this object of religious thought and worship as a self-conscious intelligence to whose will the individual and society must conform, may it be conceived as the cosmic order in process of self-evolution, of which man is a part and which he, in turn, helps to create? The religious ideal as a

cf. article by him in *The Medical Times*, Oct. 1914. According to this theory, self-control is entirely spontaneous and primarily a matter of germinal qualities that develop, under normal conditions, in all but the feeble-minded. This automatic self-control, if there be such, is not the kind the author has in mind, but the control that comes through training and is at least in part the result of *conscious effort*. In both cases, however, there is struggle, for struggle, as we have seen, is a determining factor in the development of germinal capacity including these inhibitors; effective training has a considerable element of coercion, and conscious effort is anything but "spontaneous." We seem justified in saying, then, that power of active adaptation is dependent on struggle or mal-adaptation in some form and to some degree.

mental construction is a human invention. Is the final cause in some sense and degree a human creation ?

If the absolute is experience, as Bradley holds,<sup>1</sup> or if the cosmic process is itself creative, as according to Ward and Bergson, then man may have as his religious goal not simply conformity to the will of God or to the unfolding of the cosmic order, but he may even dare to make the cosmic order conform, in some small degree, to his ideal and minister to his needs. Primitive man endeavored to "manipulate" God or the gods by sacrifice, incense, prayers, etc. The Christian of today seeks to win favor and the supply of his needs by prayer, and in the thought of many, by the kind of life that merits divine favor. Comparatively few have attained the thought of *compelling divine favor* by living in conformity with divine (because cosmic) laws;— and fewer still have gone so far, probably too far, as to believe that there is no other divine law than just these laws we have been and are discovering, formulating and *controlling* in the realms of nature and mind. Are we warranted in taking the step, then, of asserting that as the incarnation of creative intelligence, men as creators are making cosmic laws, and in a sense *making the God they worship* ? If so, we have a new and final form of adaptation which might be called *active religious adaptation*, but as this assumes that there is no higher form of consciousness, thought, feeling or will than that possessed by man, we cannot give our assent to this hypothesis.

<sup>1</sup> *Appearance and Reality.*

## CHAPTER XVII

### SUMMARY AND CONCLUSION

THE purpose of our investigation as set forth in the Introduction was to make a historical approach to a constructive social philosophy having as its central theme adaptation in its four-fold aspect of passive material and spiritual and active material and spiritual, — this approach beginning with Auguste Comte and Herbert Spencer, though in a few cases including previous writers whose contributions seemed essential to an appreciation of those coming later. The method chosen was to review briefly the social theories of writers in this field who have been most influential in the development of the doctrine of adaptation, and in an order so far as possible, both historical and logical.

Comte's *Positivism* was reviewed as a fitting prolegomenon to social philosophy and it was shown how he had contributed to the problem and formulated this principle of adaptation in its various aspects though with different terminology. His chief contribution, we saw, was his insistence on the possibility of a scientific study of society, and the necessity of such a study as the basis of social reconstruction. Comte, however, did not believe in cosmic evolution, so his system was a "subjective synthesis" without a necessary objective correlate.

Herbert Spencer is to be credited with the first comprehensive attempt to formulate the principle of cosmic evolution and this he did in terms of increasing differentiation and integration. In his *Social Statics*, he formulated the principle of adaptation and applied it as a test to various institutions. In his *Progress, Its Law and Cause*, he worked out the organic analogy as applied to society. In his *Sociology*, he showed how the general law he had formulated for cosmic evolution applied to the development of society as a whole but especially to various social institutions, giving much consideration to primitive conditions. We noted that while the theory of passive adaptation, both physical and

social, was developed to a high point by this author, he gave almost no place to the concept of active adaptation.

With a discussion of these two founders of sociology considered both as a science and philosophy, we turned to a discussion of methodology, considering especially the statistical method as developed by Quêtelet, the analogical method finding its most complete expression in Lilienfeld, the method of classification as exemplified by De Greef, and the inductive method as outlined by Comte and used by Darwin and his successors, — this method including the historical and what we termed the inverse historical, or the study of the present as a key to the interpretation of the past.

Turning to the subject of passive physical adaptation, we contrasted the theories of Lamarck and Darwin, the former holding that variation and progress were the result of the activity of the organism in response to felt need of adjustment to life conditions, these useful variations being transmitted by heredity; the latter laying chief stress on the passivity of the organism and the active character of nature in selecting, as it were, for survival, those organisms and species particularly qualified to win out in the struggle for existence (including the leaving of offspring), though resorting at times to the supplementary principle of use-inheritance. We reviewed also his *Descent of Man* in which the same principles are used to explain the development of social instincts, conscience, and indeed, all the qualities that go to make the winning individual and group. The contributions of Weismann, De Vries and Mendel were mentioned and a brief survey given of the standing of Darwinism today among leading biologists. Their disagreement on points of vital importance in social philosophy led to the conclusion that biology furnished, as yet, a precarious foundation for a constructive theory of social progress. In almost every case, however, *adaptation* was the one thing insisted upon, though some gave wide latitude to the degree necessary for survival.

This general spirit of uncertainty or positive disagreement furnished us a background for the study of social philosophers who have built their theories on the neo-Darwinian formula and



we concluded that their analogical method was unsatisfactory, also that the biometric method of the Galton Eugenics Laboratory had not as yet yielded conclusive evidence as to the relative influence of "nature" and "nurture," because the data were unreliable and because of the inherent difficulty of separating these two factors. Evidence brought forward in later chapters has tended to confirm this conclusion and to leave us in uncertainty as to whether or not progress from the far distant period of the Neanderthal and Cro-Magnon types of man has been in native mental ability or merely in somatic variations in the line of organic adaptation to geographical environment, and in acquired intellectual and moral qualities transmitted by social heredity. The arguments of the neo-Darwinian sociologists are too largely deductive and analogical to be conclusive, whereas at least some of the evidence produced by the environmental school is inductive and indisputable. The former to a large extent have made the cardinal mistake of assuming that the different races of mankind are analogous to biological species whereas at present the consensus of opinion is that there is but one species, while the term "race" has no definite connotation. Evidence concerning the difference in social instincts, keenness of sense perception, and intellectual and emotional qualities between primitive and modern man is so conflicting as to counsel moderation of statement rather than dogmatism. The evidence on the whole, however, indicates that as there have been somatic variations making for better adaptation to life conditions, especially in the decrease in the size of the mandibles, in pigmentation and acclimation, so there have been variations in the nervous system and brain tissue making for greater adaptation to the conditions of existence and success imposed by modern life in civilized nations. Differences in individuals are unquestioned, but when the group is made the sociological unit the standard of ability is no longer individual but social, and we have no sure word concerning the native ability of the average in any civilized nation today as compared with the average in any primitive group now extant or that ever existed. No two groups come into competition now, and never have, so far as we know, under such conditions that we

can be assured that the success of the winning group has been merely on the basis of native ability rather than on opportunity and training.<sup>1</sup> This suggests as a definite criticism of the neo-Darwinian sociologists that just as the severity of competition among lower biological orders is in dispute, so among social groups it is by no means certain that inter-group competition is now or ever will be so acute as to eliminate all but the best adapted.

The biological sociologists make much of societal selection as a method of improving native ability, — and well they may, — but at present we have little knowledge of value as a guide. Before agreement can be reached on many of the points involved we must await further evidence concerning the correlation between physical qualities on the one hand and intellectual and moral qualities on the other, for societal selection in so far as it is non-purposeful, like natural selection, works only by death or sterility. As to positive eugenics, we need to know more concerning the native qualities which, when trained, will make for the most efficient group life. We need to know more also concerning the various methods of societal selection and “counter selection”<sup>2</sup> that we may encourage those that are favorable to the production and preservation of socially efficient individuals and prevent from operation those that are unfavorable.<sup>3</sup> The goal, of course, is to work out

<sup>1</sup> If 1,000 babies born from the aristocracy of America, 1,000 babies from the proletariat class and 1,000 babies born from some primitive group could be reared under like conditions and at maturity brought into some kind of competition we would have the conditions for a sociological test of value in determining race-stock efficiency. But even in this case the test would not necessarily be physical vigor or military prowess except in so far as necessary for self-preservation, nor yet industrial superiority except in so far as necessary for cultural achievement. While these tests would be valid in proportion as existence and growth of the groups were vitally involved, if the competition was no more severe than among civilized groups today the test might well be the ability to work out a corporate life so manifestly desirable that it would be copied, with variation, by the other groups and not only in one instance but continually, for the supreme test is “in the long run.” The supremely desirable thing is not only the immortality of achievement as the term is used by Ward, but the continuous achievement of an immortal group, and immortal because it continues to achieve that which is worthy of imitation.

<sup>2</sup> See A. G. Keller, *Societal Evolution*, ch. VI.

<sup>3</sup> Cf. Walter, *Genetics*, ch. XI.

that kind of social life, social organization and social control which shall result eventually in the birth only of those who, when properly trained, will fit most effectively into the life of the group and of humanity at large.<sup>1</sup>

These criticisms of the neo-Darwinian sociologists have forced us to introduce conclusions from later chapters, — and now to return to the progress of our investigation. We turned from this school to a consideration of passive socio-physical adaptation, or the development of social groups with reference to their physical environment, and concluded that geographical conditions “set the life lines of groups,” condemning some to isolation and stagnation and opening up to others possibilities of enlarged life not only by affording better facilities for self-support but also by inducing inter-group contact.

Up to this point emphasis had been chiefly on the physiological basis of race-progress with race conceived in biological terms, but anthropologists having assured us that there are at present no pure races and that ethnic groups must be defined with reference to cultural even more than to physical characteristics, it was necessary to turn to some writers who had developed the thought of society as a psychical unity, and the more so as the concept “society” had been used without definite content.

In the discussion of Schäffle, Mackenzie, Le Bon, Durkheim and other social psychologists, we developed the concept of society as a psychical “somewhat,” variously organized, in a sense over against the individual, molding his life and in turn modified by his reaction. This brought us to the phase of our subject characterized as *passive spiritual adaptation* and an approach to social philosophy through social psychology, — though to a considerable extent of a deductive variety. We concluded that every group or social organization, united by common interests and co-operating for a common end was a psychical unity with the possibility that such a unity might at certain times and under certain conditions rise to such community of thought,

<sup>1</sup> For the most recent attempt to work out a social philosophy on the biological basis, using the terms variation, selection, transmission and adaptation as “key-words,” see the admirable book by Professor A. G. Keller of Yale, *Societal Evolution*.

feeling and volition as to warrant the application of such terms as *social organism*, *social consciousness* and even *social personality*.

The next line of development considered was through those social philosophers who had emphasized an inductive study of the social process, dividing the writers into three groups: the anthropological, dealing largely with primitive man and the beginnings of social evolution, the historical, endeavoring to analyze the forces at work in the progress of civilization and trace the causal nexus, and another group attempting to explain social evolution in terms of some one law or principle. We noted the large use of the concept of adaptation by Sumner and Boas, the one interpreting social progress almost entirely in terms of natural selection, the other, in terms of environmental influences, and showed how useful this concept had been in explaining ethnic and social origins. We saw how Gumpłowicz by his teaching concerning progress by inter-group conflict and cross-fertilization of cultures, and Ratzenhofer by his theory of interests had enriched our knowledge of progressive social adaptation, and finally how through the contributions of the third group of writers we had been enabled to understand the process of association and integration within each society.

As a net result of our study of the phenomena of association up to this point, we have reached the concept of society as a psychological organization with some sort of self-consciousness and will, revealed at least on occasion; we have seen how societies are evolved, on the one hand, by such inner forces and processes as social and sexual selection, division of labor, consciousness of kind and consciousness of supplementary difference, sympathy, mutual aid, suggestion, imitation and social constraint, — by a process, that is, of *inner co-adaptation* (largely passive), and we have noted, on the other hand how such societies are evolved by a process of progressive adjustment to their geographical and super-organic environments by natural selection and acclimation, by inter-group contacts and conflicts, by racial and cultural assimilation and amalgamation, by social suggestion, imitation and constraint, — by a process, that is, of *outer adaptation*, — and this, too, largely passive.

In all our discussion, however, while chief stress has been laid on progress by these non-purposeful reactions between societies and between societies and their constituent units, the function of individual and social *purposeful* activity has been brought to view, especially in the theories of Baldwin and Giddings with emphasis on the social goal of "the evolution of personality through ever higher stages until it attains to the ideal that we name humanity."<sup>1</sup>

With a brief discussion of some of the factors that enter into the transition from matter to mind, from unconscious to purposeful activity, — from passive to active adaptation, — with special attention to Fiske's theory of "prolongation of infancy," we turned to a consideration of the social theories of some who had stressed purposeful activity as expressed in active material adaptation. We noted Ward's contributions concerning material achievement, individual and social teleosis, and the power of "nurture" as contrasted with "nature." We considered Pat-ten's theory of "pain-pleasure-creative economy" with well-being measured in terms of health, wealth and culture, and reviewed at length the social theory of Carver with a criticism of his "gospel of the productive life." We saw that with him the goal of cosmic evolution was the super-group possessing the earth by virtue of its greater group efficiency, this efficiency, in turn, being measured by the sum of the efficiency of the individual members as properly organized, directed and controlled.

Having considered with these writers the fundamental need of active material adaptation we turned to a discussion of active spiritual adaptation and reviewed at length the social philosophy of Novicow as revealed in *Les Luttes*, bringing out his four-fold

<sup>1</sup> Giddings, *Principles of Sociology*, p. 421. Ellwood phrases the goal as follows: "The goal and purpose of our life . . . is not self-realization, but the progressive realization of a society of harmoniously adjusted individuals." — *Sociology in its Psychological Aspects*, p. 393. According to Mackenzie, the social goal includes three elements: the subjugation of nature, the perfection of social machinery and personal development including self-restraint. "What we want," he says, "is not a universe in which we may enjoy ourselves, but a universe that shall be interesting, i. e., one to which we may devote ourselves, and in devotion to which we may find the realization of a higher life than that of our individual selves." — *Introduction to Social Philosophy*, ch. IV.

doctrine of adaptation, his teaching concerning the hierarchy of struggles culminating in group rivalry for excellence carried on by free assimilation, by provoking imitation, and by an organized propaganda for the extension of its culture. We considered next a group of writers who have exalted the place of the individual as the instigator of social movements in the line of better adaptation and welfare, as Carlyle with his Great Man theory and James with his modification of this interpreted by his doctrine concerning the "Energies of Men," also Ross with his analysis of social control, concluding that natural sanctions must be supplemented by those that are artificial, created by the *élite*. We turned then to the function of idealization as set forth by Comte, Ross and Baldwin, noting its expression in art, reflective morality and religion and its culmination in reverence for ideal personality and religious adaptation. We concluded that idealization especially when reflective was one of the most potent factors in social progress.

In the study of this process of active spiritual (including social) adaptation, several concepts stand out with great clearness: idealization, innovation, reflective imitation, rivalry in excellence, and the provoking of imitation by the power of example, all of these processes, though primarily individual, having a social analogue. This analogy between the psychical activity of individuals and social unities, together with the fact that the individual is a social product and should have a social goal, warrants the use of the term social-personalism to indicate the social philosophy that has emerged in outline from our study of the development of the doctrine of adaptation as a theory of social progress. By this phrase is meant that the acme of cosmic evolution is not the social group even in its collective activity (unless it can be interpreted as a quasi-personality), but the individual person, for personality alone has power over the cosmic process, the group always acting on the initiative of persons, — but this personality socially determined and with a social goal.

To analyze this concept more in detail: Mind is superior to matter for it knows, feels and controls it, within limits. Reflective creation is the highest form of intellectual activity and personal

affection, of emotional activity. Now reflective creation and affection are functions of the individual, never of a group, however much the individual may be determined by his social environment. This truth, together with some metaphysical considerations, warrants the use of the term *personalism*.<sup>1</sup> But this very fact of the determination of the individual by society warrants the qualifying word *social*, and finally, the fact that in the highest forms of associational activity we have such a "togetherness" of self-conscious activity that approach is made to the phenomenon of personality, and that the goal of the individual is not merely personal but also some form of associational well-being, warrants the compound *social-personalism*. Let us note how this concept has grown out of our historical survey of the development of the concept of adaptation: —

In our study of biological evolution we saw how the individual organism was the product of the species and of the material environment (with due allowance for mutation), also how the good of the species including future generations seemed to have consideration above the welfare of the mere individual. We have seen that personality is likewise the product of physical and social heredity and of social suggestion, i. e., it is a social product, modified by individual reaction in the line of variation. Thus are evolved temperament, intellectuality, moral judgment, religious sentiment, — indeed all the qualities that constitute and differentiate personalities. But this personality cannot be satisfied with mere self-development. Social instincts and social interests impel to ever widening activities and an ever enlarging "self" and "self-regarding sentiment."<sup>2</sup> Thus normally the goal of the individual cannot be merely *selfish* in the narrow sense but *social* and one can find true happiness only in *social adaptation*, and the highest happiness only in the consciousness that the individual life is unfolding in harmony with the cosmic order or with the divine will, — i. e., in *religious adaptation*.

With self-development comes an expanding net-work of conflicting and co-operating interests, those of the "inclusive" group

<sup>1</sup> Cf. *Personalism*, by B. P. Bowne.

<sup>2</sup> McDougall, *Social Psychology*, pp. 174 ff.

taking precedence over those of the "included" groups, requiring sacrifice on the part of these smaller unities. The individual must at times deny his physiological and egoistic interests<sup>1</sup> for the satisfaction of his racial and social interests as represented in his family; and the welfare of the family and its constituent members must at times be sacrificed for the social interest as represented in the state. This problem of conflicting interests between individuals and groups finds a solution as soon as all can be united in the attainment of a common purpose. War does this temporarily, and Novicow has suggested the possibility of union for cultural expansion, but this is a far distant goal. Now organization, it would seem, offers the desired remedy. There is no friction in the perfect organism. The individual is able to organize his various interests, — often conflicting, — by making them all tributary to the attainment of a life purpose. Such is the power of personality. Just in proportion, too, as various social unities attain quasi-personality will such organization of interests be possible as shall reduce friction to a minimum.

Social evolution seems to be aiming not only at the development of groupings of ever increasing size and complexity but also of ever increasing integration and organization which means specialization on the part of the various unities that make up the whole.<sup>2</sup> In the human personality we have the highest type both of integration and of specialization with this difference between it and all other unities: The biological organism is constituted of parts that have no value except in relation to the well-being of the whole, thus specialization is entirely subordinated to the need of organic adaptation. In all social unities, however, as Spencer insisted, the individual has value on his own account. He is an end, not merely a means. The organization of group interests, then, and the demand for specialization on the part of the constituent members must be carried on with due regard for this worth of personality, — and so it is in the long run, for the group that does not follow this procedure is doomed to fail.

<sup>1</sup> Following Ratzenhofer's classification.

<sup>2</sup> There seems to be a limit, however, to this movement, noted especially of late in industry.



We agree with Giddings, Baldwin and others that society is a psychological organization but insist that "society" must be given content and interpreted so as to include these various conflicting, co-operating, combining unities, each a quasi-organism with a super-organic environment to which it must adjust itself, each a potential quasi-personality. We agree, too, with Schäffle who holds that the individual should seek to find his place in society, fit himself to function there as efficiently as possible and that society should assist in this process. We hold that the same should be true of every social unity, — of the family, of the church, of the club, political party or state.

*Just as individual personality, then, is not only socially conditioned but has a social goal, viz., to function as efficiently as possible in ever enlarging social unities, — so should each of these social unities as it attains quasi-personality seek to function as efficiently as possible in the more inclusive social organizations of which it forms an integrating part.*

Approaching this same problem from another point of view, we have seen that social evolution reveals an ever increasing power of active adaptation and of progress by co-operation, innovation and reflective imitation rather than by struggle for existence and survival. Now *that which is increasingly imitated is personal and group adaptive activity*; i. e., as the normal physical organism is continually reacting to stimuli along the line felt to be life-preserving and life-enlarging, so the conscious personality, in so far as guided by real interests, imitates, with adaptive variations, other persons in the line of increasing well-being; and groups, in proportion as organized and directed by intelligence, also imitate other groups in their adaptive activities. The individual, moreover, has as a copy for imitation not only the real but the ideal which, as Baldwin has shown, is a social product. So every quasi-personal social unity may form a group-ideal, — as in the case of labor unions, fraternities, communities, — which is far above the real of present attainment. This group-ideal, too, is a social product and one in which the super-organic environment plays a most important part, and usually this ideal includes not only the welfare of its members, but also that of a

more inclusive social unity. The church-ideal, for example, includes the "denomination" or Christianity as a whole; that of the local union includes the trade union or the "laboring class."

This leads to a point where we can suggest a social goal so far as I know not previously formulated in social philosophy,<sup>1</sup> and with no word to express it, I suggest *exemplification*<sup>2</sup> to complete the triad begun by *innovation* and *imitation*.

This ideal of living a life that shall enter into other lives by the power of example is by no means new as applied to individuals. It seems to have been prominent in the consciousness of Jesus when he said "Follow me"; when he taught that he was the Way, and when he said to his disciples, "Let your light so shine before men that they may see your good works." We find it in the words of Paul (I Cor. xi. 1): "Be ye followers of me even as I also am of Christ."<sup>3</sup> This ideal as applied to groups is new, however, so far as I know, with the possible exception of the Hebrew prophet who taught that Israel should be a "light to the Gentiles" (Isa. xlix. 6), but even here the thought seems to be that of social service by supremacy and social control, rather than by the persuasion of example.<sup>4</sup>

The doctrine is just this: Every social unity, — family, church, club, village, city, state, nation, — should have as its goal self-preservation and self-enlargement, and should be led to see that these can be secured best (1) by striving to develop such an

<sup>1</sup> Novicow's analysis of adaptation and his phrase "provoquer l'imitation" were unknown to the writer until the manuscript was in the hands of the printer. Chapter XIV was afterwards written and a few changes made in this chapter. With Novicow, however, individual pleasure is the goal of life and individual and social processes including "provoquer l'imitation" are considered but means to that end dictated by self-interest. Our position, on the contrary, is that active adaptation is the end and pleasure and pain sign-boards to indicate the right way.

<sup>2</sup> The words *exemplification* and *exemplariness* have somewhat different meaning.

<sup>3</sup> "Μιμηταί μου γίνεσθε, καθὼς καὶ γὰρ Χριστοῦ. Cf. II Thessalonians, iii. 7-10.

<sup>4</sup> Cf. Ward's "immortality of achievement." The highest form of struggle and rivalry, as Novicow has shown, and the form most potent in social progress, is rivalry in excellence, i. e., struggle for that attainment that shall become immortal through reflective imitation. "Imitation" as here used, so too, "example" have the broad meaning of Tarde and Baldwin with no thought of slavish copying. In this sense a person is imitated as his life is a source of inspiration and suggestion. Only in this sense is Jesus the example for man.

organized life and one so manifestly helpful to its members that it will increase by the power of attraction and by the spread of its principles and methods by reflective imitation on the part of other groups so situated that these principles and methods are practically imitable, and (2) by seeking to function as efficiently as possible in a more inclusive group; i. e., to find or make its place in a still larger organization. Its intrinsic goodness<sup>1</sup> may be determined by social judgment, its extrinsic goodness by its efficiency as a member of a more inclusive organization and by its spread through reflective imitation on the part of other groups likewise inspired by a purpose of attaining the highest possible success measured in terms of social well-being.

This social philosophy called social-personalism includes the following elements: —

I. *The supreme worth of the individual* because he is the highest expression of cosmic evolution as measured by his creative activity in the line of active material and spiritual adaptation, the former giving him power to coerce nature in the line of ministering to his needs, the latter giving him power (a) to react on society by imitative variation, innovation and suggestion; (b) to influence men in the interest of self-satisfaction; (c) to form ideals and conform or adapt his life progressively to them; (d) to win his fellow-men by example and persuasion, to the acceptance of his ideals and so restore the social equilibrium disturbed by his creative variation from the standards of the group, and (e) in conjunction with others, to compel social adaptation on the part of social laggards and the anti-social.

II. *The individual goal of self-development and social efficiency.* The first is called for (1) because of the intrinsic value of personality, and (2) as a basis for passive and active adaptation both on the part of the individual and of society, and the second is called for to give specific direction to self-development and activity; i. e., it is not mere self-development that makes for individual well-being and social strength, but the kind of development that fits the individual for the place in social life that he can fill supremely well according to his capacity. This goal of social

<sup>1</sup> For use of the terms intrinsic and extrinsic, see Palmer, *op. cit.*, pp. 18 f.

efficiency, moreover, requires that each should find his place in the various organizations to which he belongs, increase his efficiency for that place to the highest degree (with due regard to conflicting interests), and use his influence to strengthen the organization in its task of survival, growth and social utility, and in its attempt to form and attain the group-ideal of functioning in a larger social unity.<sup>1</sup>

III. *The responsibility of society for the character of every personality.* Every member of a group is now very largely a social product. A society can have the kind of members it really wants. Social conscience, then, should be made to feel that it is responsible for the character of every individual.

IV. *The general ideal for every social quasi-personality (or unity) of social exemplification; i. e., to work out such an organized life and one so fruitful in securing the highest possible well-being of its members and of humanity as a whole, that it will spread by reflective imitation<sup>2</sup> on the part of other social unities.*

V. *The social goal of functioning in a more inclusive unity (mentioned in II); but this goal is not to be confined to the national group as in the theories of Pearson, Carver and many German writers, but moves on in ever widening circles with the extension of co-operation and the expansion of the self-regarding sentiment until it embraces all humanity.*

The social philosophy briefly outlined, the outcome of a survey of many social philosophies written under greatly diverse conditions of thought and life, fused on a principle that seems to pervade all forms of cosmic development, — that of adaptation, — suggests answers to the problems propounded in the Introduction concerning the what, the how, the whence, the whither and the

<sup>1</sup> The goal of exemplification has not been applied to the individual for such a goal might possibly lead to a narrow self-consciousness, pride, and arrogance, though this is not probable if balanced with emphasis on social efficiency. Indeed this ideal of exemplification furnishes a principle of judging conduct that is more practicable than Kant's "Act as if the maxim of thy action were to become by thy will a universal law of nature." It is better for it makes place for the relativity which we have found is characteristic of all morality. An act might well be worthy of reflective imitation by others similarly situated and yet not such as could be used as the basis for a universal principle.

<sup>2</sup> See note 4, p. 324.

why of that process at least in its higher phases. As to the first: social evolution is the process of the formation and progressive adaptation of social unities to their ever changing physical and spiritual environment. As to the second, the "how," this process may be described in terms of the "dialectic of growth" or a "give-and-take" between the psychical unities and their physical and spiritual environment. The evolution of every social group is like an ascending spiral in the form of an ellipse with two foci, the *socius* and the various *associational groups* that are gradually formed by the process of differentiation and integration. In this process the conflict of interests and mal-adaptations on lower planes of life result in co-operation, in higher adaptations, and in the organization of interests both individual and social. But the process thus described in thought terms does not adequately represent the real life of values given in experience which is too rich and too large to be subjected to such an analysis. Life must be experienced and appreciated, not merely analyzed and described.

Viewed historically, this process of experience and appreciation shows development in three directions: (1) the self-conscious personality has attained greater power over self, nature, and fellow-man, and in its search for the true, the beautiful and the good, has come to believe in a Final Cause which it tends to personify in exaggerated terms of its own powers and values, and to worship as God; (2) the self-conscious personality has enlarged in interest, in sympathy, in purpose, in self-feeling, till it includes in certain experiences all humanity. Now this self-conscious personality in these experiences of power, of intuition, of evaluation, of up-reach and out-reach, is the highest form of reality that can be grasped by consciousness, but there is reason for belief that the God of idealization, and the *socius* of religious feeling, is a still higher form of reality and personality, though impossible of expression in terms of discursive thought; (3) experience and appreciation, though in the last analysis personal, have a social basis and a social outlook. Out of this fact have developed social organizations with common interests and a common goal. Such interest groups, as we have seen, may

become quasi-personalities, and as such are a second fruitage of cosmic evolution. Now out of these three lines of development of experience and appreciation, intensive personal, extensive personal, and social, together with the realization that development has come through struggle, issues the belief that cosmic evolution has not in any of its phases been the mere outcome of the interaction of blind forces but rather the expression of Intelligence and Love.

The "how" of the process suggests the "whither" and "why." If the phenomenal order is a universe, a *cosmos*, i. e., if there is a world-order dependent on infinite intelligence rather than a world-disorder which is the outcome of the permutations and combinations of blind forces, a study of the process should suggest its goal. Although our discussion has brought out several suggested goals, the outcome of it would seem to indicate that nothing higher has been formulated than the *increasing adaptation of men in societies to their physical and spiritual environment*, this adaptation being interpreted in terms of *power* and *fullness of life*, attained and expressed in its highest associational forms in reflective innovation, reflective imitation and exemplification, with emphasis, too, on the affectional nature and on idealization expressing itself in art in its varied forms and in religion.

As to the true type of religion, we have noted in our survey many diverse theories from the "Worship of Humanity" (Comte), and a mere "Appreciation of the Cosmos" (Ward), to a "Living Faith in a Self-Conscious, Personal, World-Ground" (Bowne, Baldwin), while others say that there is no one true religion but that like everything else religion is relative to the stage of social development and environmental conditions of a group. The philosophy of social-personalism lends itself easily to the belief that the ultimate religion will be along lines suggested by Bowne and Baldwin, with emphasis, however, on its social aspects and its pragmatic warrant. In any case a pragmatic test is provided in the way that the religion of a group influences its associational life, and in the survival and spread of the religion either by the success of the group thus inspired in possessing the earth or the success of the associational achieve-

ments of the group in being reflectively imitated. Professor Carver asserts that the only way the Kingdom of God can come throughout the earth is by the possession of the earth by the group that accepts the "gospel of the productive life," and that the religion of this group will thus be demonstrated to be the true religion. In contrast we believe that the Kingdom of God will come by the spread, through reflective imitation, of the achievements of the groups setting the best example of social organization and collective welfare, and that the "gospel of social-personalism" working by purposeful *idealization*, *innovation*, *imitation* and *exemplification* will demonstrate its superiority over any form of deterministic monism or the gospel of the productive life as interpreted by Professor Carver.

This test of the truth of social philosophy, however, is so indefinite and far distant as to seem of little present value, but a consistent social philosophy thus tested, while desirable, is not indispensable. Most important is a working program of social amelioration that commends itself to the enlightened judgment of the sociological élite<sup>1</sup> and this is provided in the four-fold doctrine of adaptation as worked out in this study, the apparent truth of this social theory and of the social philosophy growing out of it being revealed in its manifest utility as a key to the understanding and solution of practical life problems. As applied to social problems and conditions, the theory of adaptation and the philosophy of social-personalism would seem to call for emphasis on the following factors in associational life: —

I. Production of material goods as the basis of life, growth and cultural development;

II. The elimination of waste land, waste labor and the waste of natural resources;

<sup>1</sup> A group of persons with deep interest in a social problem and such training and experience as fits them for judgment, after mature deliberation frequently attain an "insight" into an apparent solution of the problem that is akin to intuition, indeed such collective insight might well be termed "social intuition." It is nothing supernatural or mystical or innate, but a short-circuited "insight" based on experience and discussion, and accompanied by a feeling of satisfaction. This is the tribunal of final authority with reference to an action worthy of imitation, — though it may err.

III. Efficient consumption, — interpreted in terms of production (Carver), of surplus energy (Patten) or of social well-being;

IV. Education for social efficiency which will include

(a) recognition of the family as the educational as well as sociological unit;

(b) the acquirement of such knowledge, skill and training on the part of each individual as will fit him best for the place he can best fill in the industrial system or in the supply of human needs, with such direction and encouragement as will tend to relative equality of income because of relative equality in social service rendered;

(c) the acquirement of such knowledge and training as will result in social adaptation and co-operation;

(d) the development of personality and individuality with self-control, self-direction and prophetic vision to see the line of action that will make for individual and social well-being;

(e) the attainment of that religious insight and experience which will link the human life with the Eternal Source of life, thus making for increased energy and social unity;

(f) the above elements unified and energized with the educational ideals of adaptation and social exemplification.

#### V. Social Control

(a) to secure efficient race-stock and to regulate population;

(b) to deal with the anti-social and the social laggards;

(c) to prevent that competition which experience shows to be uneconomic or detrimental to well-being;

(d) to encourage such co-operation as promises to be socially advantageous, and

(e) to secure a more just distribution of wealth.<sup>1</sup>

The individual who would succeed in life must adapt himself to his environment, physical and spiritual; but most to be envied is the one who can exert the greatest influence on his fellow-men in the line of the increased well-being of all humanity, — himself included.

<sup>1</sup> Cf. the program for a constructive democracy formulated by Professor Carver, *Essays in Social Justice*, pp. 264, 265.



The club, the religious sect, the political party, the social institution of every sort which would succeed must likewise adapt itself to its environment, — so, too, the sovereign group. But mere survival should not be the goal, but this, modified by the ideal of functioning in a more inclusive unity; and while these are most frequently in harmony they are not always so. The welfare of the group at times calls for the sacrifice of the individual; it may call for the sacrifice of a club, a sect, a party, an institution. The welfare of humanity may call for the sacrifice of a sovereign group. All these unities and all forms of associational life are means to the attainment of the one supreme goal, — the well-being of the greatest number of rational individuals including not only the present but future generations.

Professor Bowne holds with good reason that well-being has two constituent factors, outward fortune and inner worth and peace.<sup>1</sup> Emphasis on material progress may produce the outward fortune but destroy the sense of worth and peace which alone makes life worth living for the individual. Emphasis on the subjective side may lead to such neglect of material welfare as to result in individual and social stagnation and decay. Both elements must have place in a social philosophy that shall satisfy life conditions and inspire to that individual and social activity that shall attain ultimately the coveted goal.

No words are better fitted to conclude this discussion than those which bring to a close Professor Giddings' *Principles of Sociology*: "A social being, the normally organized man returns to society with usury the gifts wherewith he has been by society endowed; and this truth will be the starting point of the ethical teaching of coming years. Personality cannot live within itself to perish with the individual life. It goes forth into the everlasting life of man. And so, little by little, age by age, society, which has created man, is by man transformed. Of supreme importance in this work is the influence of those few transcendent minds whose genius pierces the unknown; of those pioneers of thought and conduct who dare to stand alone in untrodden ways; of those devoted lovers of their kind who, often in obloquy and pain,

<sup>1</sup> *Principles of Ethics*, p. 304.

reveal the possibilities of a spiritual life. It is chiefly through these that the mass of humanity is lifted in some small degree above the plane of physical necessity into the freer air of liberty and light. This is the way of life that Browning has so truthfully described: —

‘ . . . Already you include  
The multitude; then let the multitude  
Include yourself; and the result were new.  
Themselves before, the multitude turn to you.  
This were to live and move and have, in them,  
Your being, and secure a diadem  
You should transmit (because no cycle yearns  
Beyond itself, but on itself returns)  
When, the full sphere in wane, the world is o’erlaid  
Long since with you, shall have in turn obeyed  
Some orb still prouder, some displayer, still  
More potent than the last, of human will,  
And some new kind depose the old.’ ”

## BIBLIOGRAPHY



## BIBLIOGRAPHY<sup>1</sup>

- Anderson, B. M., Jr. *Social Value*. Boston, 1911.
- Angell, J. R. *Chapters from Modern Psychology*. New York, 1912.
- Bagehot, Walter. *Physics and Politics*. New York, 1902.
- Baldwin, J. M. *Development and Evolution*. New York, 1902.
- *Social and Ethical Interpretations*. New York, 1899.
- *The Individual and Society*. Boston, 1910.
- *The Story of the Mind*. New York, 1901.
- Barth, Paul. *Die Philosophie der Geschichte als Sociologie*. Leipzig, 1897.
- Bateson, W. *Materials for the Study of Variation*. London, 1894.
- *Mendel's Principles of Heredity*. London, 1909.
- Bergson, H. (Mitchell). *Creative Evolution*. New York, 1911.
- *Time and Free Will*. New York, 1910.
- Block, M. *Traité de Statistique*. Paris, 1886.
- Bluntschli, J. K. *The Theory of the State*. Oxford, 1901.
- Boas, F. *Abstract Report on Changes in Bodily Form of Descendants of Immigrants*. Washington, 1911.
- *The Mind of Primitive Man*. New York, 1911.
- Boodin, J. E. *American Journal of Sociology*, vol. xix.
- Bowley, A. L. *Elements of Statistics*. New York, 1907.
- Bowne, B. P. *Introduction to Psychological Theory*. New York, 1886.
- *Metaphysics*. New York, 1898.
- *Personalism*. New York, 1908.
- *Principles of Ethics*. New York, 1892.
- *The Christian Life*. New York, 1899.
- *Theism*. New York, 1887.
- *Theory of Thought and Knowledge*. New York, 1897.
- *The Philosophy of Herbert Spencer*. New York, 1881.
- Bradley, F. *Appearance and Reality*. London, 1893.
- *Ethical Studies*. London, 1876.
- Brinton, D. G. *Races and Peoples*. New York, 1890.
- *The Basis of Social Relations*. New York, 1902.
- Brooks, J. G. *The Social Unrest*. New York, 1903.
- Buckle, H. T. *History of Civilization*. 2 vols., New York, 1897.
- Butler, N. M. *The Meaning of Education*. New York, 1898.
- Caird, Edward. *The Social Philosophy and Religion of Comte*. Glasgow, 1895.

<sup>1</sup> The books listed in this Bibliography are not merely the ones cited in the preceding pages, but also those which have furnished the background for the criticism of the various authors, and for the social philosophy sketched in the Introduction and Conclusion.

- Carlyle, Thomas. *Heroes and Hero Worship*. New York, 1885.  
 — *Past and Present*. Boston, 1887.
- Carver, T. N. *Distribution of Wealth*. New York, 1904.  
 — *Efficiency Society Transactions*. Vol. i, no. 63.  
 — *Essays in Social Justice*. Cambridge, Mass., 1915.  
 — *Harvard Theological Review*. Vol. i, no. 1.  
 — *Principles of Rural Economics*. New York, 1911.  
 — *Rivista di Scienza*. Vol. iv.  
 — *Sociology and Social Progress*. Boston, 1906.  
 — *The Religion Worth Having*. Boston, 1912.
- Castle, W. E. *Heredity in Relation to Evolution and Animal Breeding*. New York, 1911.
- Chapin, E. S. *Social Evolution*. New York, 1913.
- Chatterton-Hill, G. *Heredity and Selection in Sociology*. London, 1907.
- Coe, G. A. *The Spiritual Life*. New York, 1900.
- Colvin and Bagley. *Human Behavior*. New York, 1900.
- Compayne, G. *Herbert Spencer and Scientific Education*. New York, 1907.
- Comte, Auguste. *A General View of Positivism*. (Bridges), Routledge, London.
- *Catechism*. London, 1858.  
 — *Positive Philosophy*. 2 vols. (Martineau), New York, 1853.  
 — *Subjective Synthesis*. Paris, 1856.  
 — *Système de Politique Positive*. 4 vols., Paris, 1851.
- Condorcet, Marquis de. *History of the Progress of the Human Mind*. London, 1795.
- Conn, H. W. *The Method of Evolution*. New York, 1900.
- Cooley, C. H. *Human Nature and the Social Order*. New York, 1902.  
 — *Social Organization*. New York, 1909.
- Croll, J. *Climate and Time*. New York, 1875.
- Darwin, C. *Descent of Man*. London, 1871.  
 — *Origin of Species*. London, 1872.
- Davenport, F. *Heredity in Relation to Eugenics*. New York, 1911.  
 — *Primitive Traits in Religious Revivals*. New York, 1905.
- Davis, M. M. Columbia University Studies, vol. xxiii.  
 — *Psychological Interpretations of Society*. New York, 1909.
- Defourney, M. *La Sociologie Positive*. Louvain, 1902.
- De Greef, G. *American Journal of Sociology*. Vols. VII and VIII.  
 — *Introduction à la Sociologie*. 4 vols., Paris, 1886.  
 — *Lois Sociologiques*. Paris, 1896.  
 — *Sociologie Général*. Bruxelles, 1894.
- Deniker, J. *The Races of Man*. London, 1900.
- Deploige, Simon. *Le Conflit de Morale et de la Sociologie*. Louvain, 1912.
- De Vries, Hugo. *Species and Varieties*. London, 1905.
- Dewey, J. *Psychology*. New York, 1896.  
 — *The School and Society*. Chicago, 1904.
- Dewey and Tufts. *Ethics*. New York, 1908.
- Drummond, H. *The Ascent of Man*. New York, 1894.  
 — *Natural Laws in the Spiritual World*. New York, 1884.

- Duncan, D. *Life and Letters of Herbert Spencer*. 2 vols., New York, 1908.
- Durkheim, E. *De la Division du Travail Social*. Paris, 1893.
- *Les Règles de la Méthode Sociologique*. Paris, 1904.
- Ellis, H. *The Problem in Race-regeneration*. New York, 1911.
- *The Task of Social Hygiene*. New York, 1912.
- Ellwood, C. A. *Sociology in its Psychological Aspects*. New York, 1912.
- Engels, F. *Socialism*. New York, 1892.
- Everett, C. C. *The Science of Thought*. Boston.
- Fairbanks, A. *Introduction to Sociology*. New York, 1900.
- Ferraz, M. *Étude sur la Philosophie*. Paris, 1877.
- Field, J. A. "Progress of Eugenics," *Quarterly Journal of Economics*, vol. xxvi.
- Fifty Years of Darwinism*. New York, 1909.
- Fiske, John. *Excursions of an Evolutionist*. Boston, 1884.
- *Outlines of Cosmic Philosophy*. 2 vols. Boston, 1890.
- *The Destiny of Man*. Boston, 1899.
- *The Meaning of Infancy*. Boston, 1909.
- *Through Nature to God*. Boston, 1899.
- Fite, W. *Individualism*. New York, 1911.
- Flint, Robert. *Historical Philosophy*. London, 1894.
- Fouillée, A. *La science sociale contemporaine*. Paris, 1904.
- *L'évolutionisme des idées-forces*. Paris, 1898.
- *Psychologie du peuple français*. Paris, 1898.
- Galton, Francis. *Hereditary Genius*. New York, 1870.
- *Inquiries into Human Faculties*. London, 1883.
- *Natural Inheritance*. London, 1889.
- Geddes and Thomson. *The Evolution of Sex*. London, 1895.
- Ghent, W. J. *Mass and Class*. New York, 1905.
- Giddings, F. H. *Descriptive and Historical Sociology*. New York, 1908.
- *Elements of Sociology*. New York, 1898.
- *Inductive Sociology*. New York, 1901.
- *Principles of Sociology*. New York, 1896.
- Green, T. H. *Prolegomenon to Ethics*. Oxford, 1883.
- Gumplowicz, L. *Der Rassenkampf*. Innsbruck, 1883.
- *Grundriss der Sociologie*. Vienna, 1885.
- *Ibid.* (translation by F. W. Moore) in *Annals, Am. Acad.*, 1899.
- *Soziologie und Politik*. 1892.
- Guthrie, M. *Mr. Spencer's Formula of Evolution*. London, 1879.
- Haberlandt, M. *Ethnology*. London, 1900.
- Haddon, A. C. *History of Anthropology*. New York, 1910.
- *The Study of Man*. New York, 1898.
- Haeckel, E. *The Last Link*. London, 1898.
- *The Riddle of the Universe*. New York, 1901.
- Hall, A. C. *Crime in its Relation to Social Progress*. Columbia University Studies, 1902.
- Hall, G. S. *Youth, its Education, Regimen and Hygiene*. New York, 1907.
- Hankins, F. H. *Adolph Quetelet as Statistician*. Columbia University Studies, vol. xxxi.

- Headley, F. W. *Problems in Evolution*. London, 1900.
- Healey, W. M. *The Individual Delinquent*. Boston, 1915.
- Heineman, T. W. *The Physical Basis of Civilization*. Chicago, 1908.
- Henderson, L. J. *The Fitness of the Environment*. New York, 1913.
- Hillebrand, Karl. *German Thought*. New York, 1880.
- Hobhouse, L. T. *Morals in Evolution*. 2 vols., New York, 1906.
- *Social Evolution and Political Theory*. New York, 1911.
- Höfding, H. *Outlines of Psychology*. New York, 1893.
- Hoernes, M. *Primitive Man*. London, 1900.
- Horne, H. H. *Philosophy of Education*. New York, 1904.
- *Psychological Principles of Education*. New York, 1906.
- Howard, G. S. *A History of Matrimonial Institutions*. Chicago, 1904.
- Hudson, W. H. *The Philosophy of Herbert Spencer*. New York, 1894.
- Huth, A. W. *Life and Letters of H. T. Buckle*. London, 1880.
- Huxley, T. *Evolution and Ethics*. London, 1893.
- Jacobs, P. *German Sociology*. New York, 1909.
- James, William. *Energies of Men*. New York, 1908.
- *Pragmatism*. New York, 1907.
- *Psychology*. New York, 2 vols., 1890.
- *Shorter Course*. New York, 1892.
- *Talks to Teachers*. New York, 1906.
- *The Will to Believe*. New York, 1897.
- Janet, Paul. *Final Causes*. New York, 1894.
- Kant, I. *Critique of Pure Reason* (Müller). New York, 1896.
- Keane, A. H. *Ethnology*. Cambridge, 1896.
- *Man, Past and Present*. Cambridge, 1899.
- *The World's Peoples*. New York, 1908.
- Keith, A. *Ancient Types of Man*. London, 1911.
- Keller, A. G. *Societal Evolution*. New York, 1915.
- Kellogg, V. L. *Darwinism To-day*. New York, 1908.
- Kidd, B. *Principles of Western Civilization*. New York, 1902.
- *Social Evolution*. New York, 1895.
- King, W. I. *Elements of Statistical Method*. New York, 1913.
- Kirkpatrick, E. A. *Fundamentals of Child Study*. New York, 1890.
- *Genetic Psychology*. New York, 1909.
- *The Individual in the Making*. Boston, 1911.
- Kirkup, T. *History of Socialism*. New York, 1909.
- *Socialism*. New York, 1887.
- Kropotkin, P. *Mutual Aid*. New York, 1902.
- Lapouge, V. *Sélections Sociales*. Paris, 1896.
- LeBon, G. *Psychology of Revolutions*. New York, 1913.
- *Psychology of Socialism*. New York, 1899.
- *The Crowd*. New York, 1903.
- *The Psychology of Peoples*. New York, 1898.
- Letourneau, Ch. *The Evolution of Marriage*. New York, 1911.
- Lévy-Brühl, L. *History of Modern Philosophy in France*. Chicago, 1899.
- *The Philosophy of Comte*. New York, 1903.
- Lilienfeld, Paul von. *Gedanken über die Socialwissenschaft der Zukunft*. 5 vols., Mitau, 1873-81.



- Lilienfeld, Paul von. *Pathologie Sociale*. Paris, 1896.
- Littré, E. A. *Comte et la Philosophie Positive*. Paris, 1863.
- Loeb, J. *Physiology of the Brain*. New York, 1904.
- *The Mechanistic Universe*. New York, 1913.
- Lombroso, C. *The Man of Genius*. New York, 1891.
- Loria, A. *The Economic Foundations of Society*. New York, 1899.
- Lubbock, J. *Prehistoric Times*. London, 1872.
- *The Origin of Civilization*. New York, 1870.
- Macdonald, L. B. *Life in the Making*. Boston, 1911.
- Mackenzie, J. S. *Introduction to Social Philosophy*. New York, 1890.
- Mackintosh, Robert. *From Comte to Benjamin Kidd*. New York, 1899.
- Macnamara, N. C. *Human Speech*. 1909.
- Macpherson, H. *Spencer and Spencerism*. New York, 1900.
- Manifesto of the Communist Party*, 1898. — 4
- Marett, R. R. *Anthropology*. New York, 1912.
- Marshall, A. *Principles of Economics*. New York, 1910.
- Marx, Karl. *Capital*. London, 1887.
- Mason, O. T. *Origin of Inventions*. New York, 1902.
- Mathews, Shailer. *The Church and the Changing Order*. New York, 1907.
- *The Social Teachings of Jesus*. New York, 1897.
- McDougall, Wm. *An Introduction to Social Psychology*. Boston, 1909.
- *Body and Mind*. New York, 1911.
- McKim, W. D. *Heredity and Human Progress*. New York, 1900.
- McLennan, J. F. *Studies in Ancient History*. London, 1876.
- Mencken, H. L. *The Philosophy of Nietzsche*. Boston, 1908.
- Metcalf, M. M. *Organic Evolution*. New York, 1904.
- Mill, J. S. *Auguste Comte and Positivism*. London, 1882.
- Miller, J. E. *Psychology of Thinking*. New York, 1909.
- Monroe, Paul. *A Text-book in the History of Education*. New York, 1910.
- Morgan, L. H. *Ancient Society*. New York, 1877.
- Morgan, T. H. *Evolution and Adaptation*. New York, 1903.
- Münsterberg, H. *Grundzüge der Psychologie*. Leipzig, 1900.
- *Psychology and Life*. Boston, 1899.
- *Psychology and the Teacher*. New York, 1909.
- *The Eternal Life*. Boston, 1905.
- *The Eternal Values*. Boston, 1909.
- Nearing, Scott. *The Super-Race*. New York, 1912.
- Nietzsche, F. *A Genealogy of Morals* (Hausmann). New York, 1897.
- *Human, All too Human* (Harvey). Chicago, 1908.
- *The Case of Wagner* (Common). New York, 1897.
- *Thus Spake Zarathustra* (Tille). New York, 1896.
- Nordau, Max. *Degeneration*. New York, 1895.
- Novicow, J. *Les luttes entre les sociétés humaines et leurs phases successives*. Paris, 1893.
- Osborn, H. F. *From the Greeks to Darwin*. New York, 1894.
- O'Shea, M. V. *Education as Adjustment*. New York, 1903.
- Packard, A. S. *Lamarck*. New York, 1901.
- Palmer, G. H. *The Nature of Goodness*. Boston, 1903.

- Parmelee, M. *The Science of Human Behavior*. New York, 1913.
- Patten, Simon N. *Heredity and Social Progress*. New York, 1903.
- *The Development of English Thought*. New York, 1899.
- *The New Basis of Civilization*. New York, 1905.
- *The Reconstruction of Economic Theory*. *Annals, Am. Acad.*, 1912.
- *The Social Basis of Religion*. New York, 1911.
- *The Theory of Prosperity*. New York, 1902.
- *Theory of Social Forces*. *Annals, Am. Acad.* 1896.
- Patten, William. *Evolution of the Vertebrates and their Kin*. Philadelphia, 1912.
- Paulsen, F. (Thilly). *A System of Ethics*. New York, 1903.
- Peabody, F. G. *Jesus Christ and the Social Question*. New York, 1901.
- *The Approach to the Social Question*. New York, 1909.
- Pearson, Karl. *Laboratory Lecture Series*. London. } (Periodical Publica-  
 — *Memoirs*. London. } tions.)
- *National Life*. London, 1901.
- *The Grammar of Science*. London, 1900.
- Pemberton, H. *The Path of Evolution*. Philadelphia.
- Perry, R. B. *The Approach to Philosophy*. New York, 1905.
- *The Moral Economy*. New York, 1909.
- Pratt, J. B. *Psychology of Religious Belief*. New York, 1907.
- Quètellet, L. A. J. *Du Système Social*. Paris, 1848.
- Rae, John. *Contemporary Socialism*. London, 1891.
- Ratzenhofer, G. *Sociologische Erkenntnis*. Leipzig, 1898.
- *Soziologie*. Leipzig, 1907.
- *Wesen und Zweck der Politik*. 3 vols., 1893.
- Rauschenbusch, W. *Christianity and the Social Crisis*. New York, 1907.
- Ripley, W. Z. *Races in Europe*. New York, 1899.
- Rogers, A. K. *Modern Philosophy*. New York, 1899.
- Romanes, G. L. *Darwin and after Darwin*. Chicago, 1896.
- Ross, E. A. *Foundations of Sociology*. New York, 1905.
- *Sin and Society*. Boston, 1907.
- *Social Control*. New York, 1901.
- *Social Psychology*. New York, 1908.
- Royce, J. *Herbert Spencer*. New York, 1904.
- *The Philosophy of Loyalty*. New York, 1908.
- *The Spirit of Modern Philosophy*. Boston, 1892.
- *The World and the Individual*. New York, 1900.
- Ruediger, W. C. *Principles of Education*. Boston, 1910.
- Sabatier, A. *Outlines of a Philosophy of Religion*. New York, 1897.
- *Religions of Authority*. Boston, 1904.
- Saleeby, C. W. *Methods of Race-Regeneration*. New York, 1911.
- *Parenthood and Race Culture*. New York, 1908.
- Schäffle, H. C. A. *Abriss der Soziologie*. Tübingen, 1906.
- *Bau und Leben des Socialen Körpers*. 4 vols., Tübingen, 1875-78.
- Seager, H. R. *Professor Patten's Theory of Prosperity*. *Annals, Am. Acad.*, 1902.
- Seligman, E. R. A. *The Economic Interpretation of History*. New York, 1903.

- Semple, Ellen C. *Influences of Geographic Environment*. New York, 1911.
- Shaler, N. *The Neighbor*. Boston, 1904.
- Sidgwick, H. *Outlines of the History of Ethics*. London, 1886.
- *The Methods of Ethics*. New York, 1893.
- Skelton, O. D. *Socialism*. Cambridge, 1912.
- Small, A. W. *General Sociology*. Chicago, 1905.
- Small and Vincent. *An Introduction to the Study of Society*. New York, 1894.
- Smith, Adam. *Theory of Moral Sentiments*. Philadelphia, 1817.
- Sociological Papers*. London, 1904, 1905, 1906.
- Sorley, W. R. *The Ethics of Naturalism*. Edinburgh, 1904.
- Spencer, Herbert. *An Autobiography*. 2 vols., New York, 1904.
- *Education*. New York, 1861.
- *Essays, Historical, Scientific, Political and Speculative*. Vol. 1, New York.
- *Principles of Sociology*. New York, 1909.
- *Social Statics*. New York.
- *The Data of Ethics*. New York.
- Spiller, G. *Inter-racial Problems*. London, 1911.
- Storr, V. F. *Development and Divine Purpose*. New York, 1906.
- Strong, J. *Our Country*. New York, 1890.
- *The New Era*. New York, 1893.
- *The Next Great Awakening*. New York, 1905.
- Sumner, W. G. *Folkways*. Boston, 1907.
- *What Social Classes Owe to Each Other*. New York, 1883.
- Tarde, Gabriel. *La Logique Sociale*. Paris, 1894.
- *L'Invention*. Paris, 1902.
- *Social Laws (Warren)*. New York, 1899.
- *The Laws of Imitation (Parsons)*. New York, 1903.
- Thomas, W. I. *Source Book for Social Origins*. Chicago, 1909.
- Thomson, A. *Heredity and Human Life*. New York, 1909.
- Thomson, J. R. *Herbert Spencer*. New York, 1906.
- Thorndike, E. L. *Educational Psychology*. Vol. 1, New York, 1903.
- *The Original Nature of Man*. New York, 1913.
- 6 Tyler, E. B. *Primitive Culture*. London, 1871.
- *Researches into the Early History of Man*. New York, 1878.
- Veblin, T. *Theory of the Leisure Class*. New York, 1899.
- Vincent, G. *Social Mind and Education*. New York, 1897.
- Waentig, Heinrich A. *Comte und seine Bedeutung für die Entwicklung der Socialwissenschaft*. Leipzig, 1894.
- Wallace, A. R. *Darwinism*. New York, 1890.
- Wallas, Graham. *The Great Society*. New York, 1914.
- Walling, W. E. *The Larger Aspects of Socialism*. New York, 1913.
- Walter, H. E. *Genetics*. New York, 1914.
- Ward, James. *Naturalism and Agnosticism*. New York, 1899.
- Ward, Lester F. *Applied Sociology*. New York, 1906.
- *Dynamic Sociology*. New York, 2 vols., 1883.
- *Outlines of Sociology*. New York, 1898.

- Ward, Lester F. *Psychic Factors of Civilization*. Boston, 1893.  
— *Pure Sociology*. New York, 1903.
- Watkinson, W. L. *Education of the Heart*. New York, 1904.
- Weber, E. A. (Thilly). *History of Philosophy*. New York, 1897.
- Weismann, A. *Essays upon Heredity*. 2 vols., Oxford, 1891, 1892.  
— *The Germ-plasm*. London, 1893.
- Westermarck, E. *The Origin and Development of the Moral Ideas*. 2 vols.,  
New York, 1908.
- Whetham, W. C. and C. D. *Heredity and Society*. London, 1912.
- Whittaker, T. *Comte and Mill*. London, 1908.
- Wilson, E. B. *The Cell in Development and Inheritance*. New York, 1906.

## INDEX



## INDEX

- Ability, 22, 25, 26, 110, 155, 180; natural, 22, 93, 143, 144, 155, 206; organizing, 284. *See also* Capacity.
- Abnormal, 38, 143.
- Abortion, 154.
- Absolute, 175, 311.
- Absorption, 268.
- Abstraction, 19, 22, 131, 209, 260.
- Acclimation, Acclimatization, 55, 62, 114-119.
- Accommodation, 202.
- Achievement, 27, 28, 47, 127, 155, 197-199, 221-236, 329.
- Acquisition, 250.
- Activity, 34, 282, 305, 323, 331; creative, 236, 325; mental, 25, 289; political, 21, 26, 39, 74, 119.
- Adaptability, 68, 94-97.
- Adaptation, analysis of, 8-11; for active and passive physical, and active and passive spiritual (including social), *see close of the discussion of each author*; intellectual, 217, 270; moral, 37, 133, 144, 159, 217, 298; religious, 259, 298, 311, 312; mal-adaptation, 27, 43, 48, 50, 124, 173, 247, 254, 306, 327. *See also* Adjustment.
- Adjustment, 15, 23, 33, 37-39, 74, 119, 188, 217, 241; mal-adjustment, 310. *See also* Adaptation.
- Adolescence, 17, 216.
- Aesthetic, 125, 223, 232, 241, 292, 300, 302.
- Agent, 225, 233, 234, 251.
- Agriculture, 175.
- Alcohol, 95, 263.
- Alliance, 268, 269, 273, 281.
- Altruism, 27, 29, 30, 200, 248, 302, 348.
- Ambition, 25.
- Amelioration, 5, 6, 20, 329.
- America, 114, 135 n., 156, 158.
- Analogy, Analogical, 30, 46-49, 91, 94, 123, 126, 164, 320.
- Anarchy, 14, 17, 90.
- Anthropo-geography, 111-120.
- Anthropological, Anthropology, 45, 142, 150-161, 163.
- Anti-social, 34, 230, 325, 330.
- Appetite, 194, 202, 204, 244.
- Appreciation, 202, 327.
- Aristocracy, 101, 110, 133, 176, 250, 286.
- Art, Artistic, Artists, 33, 47, 113, 127, 232, 235, 249, 252, 274, 276, 299, 328. *See also* Idealization.
- Artificial, 299. *See also* Selection, artificial.
- Asceticism, 303.
- Assimilation, 136, 138, 171, 204, 229, 230, 264, 269, 273, 277, 310.
- Association, 139, 146, 182, 189, 238, 244, 277, 279, 318; based on consciousness of kind, 204, 207; based on sympathy, 182; process of, 182; psychological analysis of, 207.
- Atheism, 215.
- Attention, 63, 157, 160, 171.
- Attraction, 268, 325.
- Authority, 13, 15, 24, 25, 81, 285, 329.
- Automatic, 207.
- Bagehot, W., 3, 177-180, 185.
- Baldwin, J. Mark, 192-199, 304-312, 328.
- Barbarism, 223.
- Barth, Paul, 13, 16, 50, 123, 202.
- Beauty, Beautiful, 132, 222, 327.
- Beliefs, 6, 90, 136, 139, 187, 191, 295, 214, 243, 293, 294, 309, 328.
- Bergson, H., 4, 38, 311.
- Biological, Biology, 9, 16, 42, 73, 82, 91, 113, 123, 133, 168, 199, 223, 237, 246, 269, 314. *See also* Evolution, biological.
- Boas, Franz, 151, 155-159.

- Body, social, 45, 124-128.
- Bowne, B. P., 38, 213 n., 228 n., 233, 328, 331.
- Bradley, J., 228 n., 298, 311.
- Brain, 64, 137, 156, 209, 215, 217, 275.  
See also Intellect, Intelligence, Mental, Mind.
- Breeding, 61.
- Buckle, H. T., 105-111, 159.
- Cannibalism, 154, 271, 278.
- Capacity, 45, 64, 87, 115, 116, 144, 156, 164, 175, 209, 325. See also Ability.
- Capital, Capitalism, Capitalist, 26, 48, 104, 176, 241, 248.
- Carlyle, T., 3, 283-286.
- Carver, T. N., 8, 36, 85, 111, 151, 245-263, 326, 329.
- Cause, Causation, 17, 18, 30, 46, 110, 151, 155, 162, 307, 311; final, 17, 233 n., 310, 327.
- Celibacy, 93.
- Cell, 32, 74, 172, 188, 237, 267.
- Ceremony, 152.
- Change, 291.
- Character, 45, 92, 115, 116, 118, 134, 186, 212, 243, 326; acquired, 67, 73, 76, 94, 134, 193, 237; group, 92, 134, 154; Mendelian, 70-75, 88, 94, 116, 310.  
See also Ability.
- Characterization, 202.
- Charity, 270.
- Chastity, 65.
- Choice, 66, 79, 154, 159, 211-214, 240.  
See also Will, free.
- Christian, Christianity, 82-86, 311, 324.
- Church, 15, 144, 189, 324.
- Citizenship, 97.
- City, 118, 189.
- Civilization, 17, 21, 100, 106, 109, 127, 134, 135, 136, 142, 166, 215, 223, 227, 250, 293.
- Class, 81, 93, 103, 104, 132, 152, 164, 167, 168, 176, 295.
- Classification, 17, 18, 38, 41, 46, 49-51, 151-152, 159, 160, 234.
- Climate, 21, 56, 66, 106, 115, 118, 156, 241, 303.
- Code, 80, 159.
- Coercion, Coercive, 205, 272, 277.
- Cohesion, 202, 236.
- Colonization, Colonize, Colony, 113, 119, 224.
- Communism, 103, 133.
- Community, 137, 140.
- Companions, 298.
- Comparative, Comparison, 43, 46, 210.
- Competition, Competitive, 39, 66, 96, 132, 192, 195, 223, 247, 251, 257, 275, 279, 293, 296, 315, 330. See also Conflict, Rivalry.
- Complexity, 34, 49, 158, 163, 216, 234.
- Compromise, 29.
- Comte, A., 4, 11-28, 29, 41, 106, 123, 140, 162, 181, 199, 222, 299-301, 313.
- Conation, 231. See also Will.
- Conduct, 37, 38, 88, 109, 136, 254, 306.
- Conflict, 105, 126, 198, 202, 226, 263, 268-281, 296, 298 n., 306, 310; of ideals, 310; of interests, 11, 172-176, 247, 261, 296, 327; inter-group, 33, 117, 132, 162-170, 260, 262. See also Competition, Rivalry, Struggle.
- Conscience, social, 326.
- Consciousness, 39, 57, 170, 204, 225, 237, 269, 274, 327; individual, 139, 141, 274, 324; of kind, 138-141, 148, 155, 163, 182 n., 198, 201, 207; of supplementary difference, 138-140, 148, 201; national, 263; religious, 198, 307; self-, 63, 79, 171, 197, 308; social or group, 48, 138-141, 146, 235, 263, 274, 308.
- Conservatism, 118, 178.
- Constraint, 140, 148, 201, 276, 306, 318.  
See also Pressure.
- Consumption, 167, 234, 241, 243, 250-255, 260, 330.
- Contagion, 136.
- Contractual, 49-50.
- Control, 9, 24, 33, 39, 40, 160, 217, 226; self-, 134, 202, 242, 255, 310, 330; social, 91, 132, 242, 243, 248, 250, 257, 263, 291-297, 324; criteria of, 297; limits of, 297; system of, 295.
- Conviction, 194, 286.



- Cooley, C. H., 191 n., 192, 201.
- Coöperation, 20, 33, 65, 87, 126, 138, 142, 194, 204, 231, 257, 261, 279, 280, 308, 311, 326, 327.
- Correlation, 96, 116, 185, 278, 316.
- Country, 118.
- Courage, 25, 65, 87, 290.
- Create, Creative, Creation, Creators, 18, 30, 147, 148, 170, 224, 243, 270, 283, 304, 320, 321. *See also* Activity, creative.
- Crime, Criminal, 45, 118, 140, 141, 241, 254.
- Criticism, 154.
- Cross-breeding, 135, 157, 169, 188, 229.
- Cross-fertilization of cultures, 164, 226, 293-294.
- Crowd, 138.
- Culture, Cultural, 20, 112, 115, 117, 118, 132, 155, 166, 242, 260, 268, 271, 273, 293; primitive, 175, 209.
- Custom, 27, 160, 178, 182-185, 293, 297.
- Cycle, 65, 124, 166, 235, 256.
- Darwin, C., Darwinism, 28, 58-79, 106, 125, 189, 222, 288. *See also* Neo-Darwinian.
- Davenport, C. B., 42, 74, 98, 310.
- Davis, M. M., 147, 191.
- Decision, 287.
- Deductive, 42, 46, 120, 233, 237.
- Defect, Defective, 93-102, 262, 310 n.
- Degeneration, 74, 86, 87, 96, 98, 99, 135, 223, 234, 241, 292.
- De Greef, G., 49-51, 151.
- Delinquent, 95 n.
- Democracy, 206, 286, 330 n.
- Denationalization, 272, 275.
- Dependence, 49, 173, 307.
- Design, 307.
- Desires, 21, 27, 165, 187, 191, 198, 204, 231, 235, 238, 241. *See also* Interests, Needs.
- Despot, Despotism, 178, 250.
- Determinism, 166, 168, 190, 211, 213, 233; economic, 103-106.
- Development, 124, 126, 162, 170-180, 191, 221, 223, 272, 329; cultural, 158; industrial, 9, 155, 262; moral, 159; innate tendency to, 21, 27, 39, 73, 77, 125, 128, 170-180, 222-227; *see separate modifying words, as above, also* Evolution, Progress.
- De Vries, H., 70-71.
- Dialectic, 106, 192, 308, 327.
- Differentiation, 20, 36, 128, 134, 165, 186, 192, 327.
- Discipline, 154, 205.
- Discussion, 177, 178, 205, 329.
- Disease, 48, 66, 119.
- Distribution, 33, 34, 330.
- Divine, 311.
- Division of labor, 33, 34, 62, 126, 128, 134, 140-145, 241, 276.
- Divorce, 118, 258.
- Dogma, Dogmatic, 86, 110, 158, 200.
- Domestication, 59, 63, 157.
- Drummond, H., 199-201.
- Durkheim, E., 123, 138-145, 185, 201.
- Duty, 33, 87, 109, 183, 261, 303.
- Dynamic, 19, 31, 85, 90, 146, 202, 208, 230-234.
- Economic, Economics, Economists, Economy, 13, 32, 36, 39, 49, 100, 113, 118, 142, 153, 155, 167, 183, 186, 222, 242, 243, 247, 256, 296.
- Education, 3, 5, 9, 23, 24, 25, 27, 38 n., 87, 96, 100, 107, 134, 136, 154, 232, 249, 257, 261, 294, 300, 330.
- Efficiency, 81, 87, 88, 94, 128, 206, 226, 242, 250, 251, 252, 257, 289, 291, 296, 316, 325.
- Egoism, Egoistic, 29, 83, 167, 174, 182, 298 n.
- Elimination, 268.
- Élite, 128, 134, 136, 137, 154, 295, 329.
- Ellwood, C. A., 79 n., 145 n., 147, 261.
- Emigration, 113, 114, 135.
- Emotions, Emotionalism, 27, 57 n., 63, 109, 206, 298.
- Endurance, 290.
- Energy, 39, 47, 87, 134, 208, 213, 239, 330; conservation of, 179; human, 241, 244, 252, 258, 286-291.
- Energies of men, 286-291.

- Enlightenment, 294.  
 Enthusiasm, 300.  
 Environment, physical or material, 8-11, 13, 21, 28, 32, 36, 38, 41, 55, 74, 78, 90, 93, 103-120, 135, 136, 155, 156, 170, 177, 186, 209, 227, 238, 287; spiritual (including social), 8-11, 13, 32, 38, 100, 138, 155, 160, 167, 175, 186, 289, 323.  
 Equality, 87, 110, 206.  
 Equilibrium, 31, 39, 226, 243, 253, 274, 279, 289, 325.  
 Equipment, 279.  
 Esteem, 252, 301, 302.  
 Ethical, Ethics, 27, 36, 37, 83, 113, 198, 255, 293, 302, 305, 306.  
 Ethnic, Ethnology, 118, 124, 164, 175, 177, 293, 307.  
*Ethos*, 154, 303.  
 Eugenics, 58, 92-102, 257, 316.  
 Evaluation, 190, 249, 327.  
 Evil, 247, 253.  
 Evolution, 7, 30; biological or organic, 28, 32, 57, 107, 125, 171, 201, 237, 238; cosmic, 31-40, 201, 215, 222-224, 229, 233 n., 235, 268, 325, 328; social, 15, 22, 31, 86, 105, 126, 136, 154, 155, 224-226, 238-240, 245, 280. *See also* Development, Progress.  
 Example, 274 n., 282, 287, 324 n., 325.  
 Excitement, 290.  
*Exemplification*, 324-330.  
 Expansion, 263, 267.  
 Experience, 17, 23, 65, 139, 149, 154, 173, 193, 212, 216, 233, 261, 286, 303, 309, 310.  
 Experiment, 42, 73.  
 Exploitation, 134, 295, 311.  
 Extermination, 66.  
 Factors, 31, 33, 39, 49, 118, 167, 210, 230, 256. *See also* modifying word.  
 Faculties, 20, 106, 157, 289.  
 Faith, 91, 207, 290, 304, 308.  
 Family, 23, 32, 36, 118, 124, 133, 138, 140, 159, 161, 167, 172, 178, 189, 216, 243, 248, 251, 257, 322, 324, 330.  
 Fashion, 182.  
 Fatalism, 213.  
 Fatigue, 247, 289.  
 Fear, 153, 206, 240, 250.  
 Fecundity, 172 n.  
 Federation, 34, 36, 268.  
 Feeling, 32, 87, 109, 131, 148, 173, 186, 213, 224, 232, 234, 238, 243, 271, 276, 299, 300, 306, 327; fellow-, 182; self-, 309.  
 Feudalism, 103.  
 Fiction, 25, 27, 301.  
 Filiation, 23, 43.  
 Fiske, John, 50 n., 182, 214-217, 259, 310.  
 Flint, R., 7, 12 n., 16 n.  
 Fluctuation, 70.  
 Folkways, 152-155.  
 Food, 56, 57, 59, 60, 106, 110, 156, 175, 249.  
 Force, Forces, 282; cosmic, 162, 170, 212, 222, 224, 225; physical, 22, 24, 31, 47, 112, 118, 127, 153, 256, 295, 328; social, 42, 112, 141, 165, 166, 173, 187, 225, 233, 239-241, 245, 272, 283.  
 Foresight, 221.  
 Fouillée, A., 144, 146.  
 Fraternity, 133, 144, 206.  
 Fraud, 295.  
 Freedom, 4, 30, 45, 47, 57, 106, 129, 132, 168, 177, 206, 211, 290.  
 Friendship, 138.  
 Function, Functional, 37, 45.  
 Galton, Sir Francis, 36, 58, 92-99, 101, 143, 157, 288 n.  
 Genesis, Genetic, 41, 42, 79, 83, 160, 192, 194, 227, 293.  
 Genius, 22, 112, 137, 153, 185, 189, 229, 231, 235, 283, 284, 288, 291, 295, 300. *See also* Innovation, Variation, social.  
 Geography, Geographical, 111-116. *See also* Environment, physical.  
 Germ plasm, 69, 75, 99, 176; social, 232.  
 Germany, 85, 167, 262, 263, 273.  
 Giddings, F. H., 17, 146, 201-207, 331.  
 Goal, 36, 127-133, 280, 311, 315, 323, 324, 331.

- God, 11, 37, 80, 200, 217, 233 n., 245, 256, 259, 307, 311, 312, 327, 329.
- Good, Goodness, 37-39, 83, 132, 154, 245, 253, 255, 325.
- Gospel, 262, 319, 329.
- Government, 20, 25, 33, 40, 110, 128, 145, 253, 257, 280, 281. *See also* Control, social; Politics.
- Gravitation, 16, 225.
- Gregarious, 193, 216.
- Group, 4, 5, 8, 31, 41, 57, 125, 153, 156, 164, 246, 253, 330; associational, 269, 327; group efficiency, 87; *see* Efficiency, social; group interests, 165, 168; *see* Interests; territorial, 262, 272; *see* Nation, State.
- Growth, 55, 192, 196, 238, 273, 308, 310.
- Gumplowicz, L., 23, 146, 156, 163-169, 175.
- Habit, 57, 79, 188, 306.
- Haeckel, E., 8, 48, 126, 209, 215.
- Happiness, 22, 109, 132, 184, 259, 277.
- Harmony, 5, 21, 64, 188, 247, 248.
- Hatred, 163, 169, 279.
- Head-form, 116, 156.
- Health, 96, 180, 244, 252.
- Heart, 21, 27.
- Hedonic, Hedonism, 182, 198, 216, 235, 272.
- Hegel, Hegelianism, 103, 128.
- Herding, 83, 175.
- Heredity, 12, 38, 56, 67, 74, 84, 93, 94, 104, 107, 154, 163, 171, 186, 193, 288; social, 27, 94, 133, 164, 193, 229.
- Hero, 167.
- Heterogeneity, Heterogeneous, 32, 37, 39.
- Hierarchy, 17, 26, 49, 146, 222; of struggles, 277-282.
- History, Historical, 39, 43, 105, 109, 114, 137, 150, 162-180, 283.
- Hobbes, T., 16, 45.
- Hobhouse, L. T., 6, 159.
- Homogeneity, Homogeneous, 32, 39, 115, 137, 204, 254, 272, 280.
- Horde, 32, 163, 205, 223.
- Humanism, 96, 103.
- Humanity, 16, 19, 22, 26, 114, 115, 127, 162, 189, 200, 215, 222, 262, 269, 276, 299, 300, 326, 327.
- Hume, D., 13, 17.
- Huxley, T. H., 67.
- Hypothesis, 18, 58, 66, 86, 91.
- Ideal, 4, 40, 85, 110, 133, 136, 143, 207, 240, 260, 311, 320, 324; formation of, 103, 304-306; personal, 4, 11, 184, 257, 294, 298, 301-305; social, 11, 125, 133, 144, 190, 224, 230, 240, 241, 309, 323; educational, 25, 329. *See also* Goal.
- Idealism, Idealistic, Idealization, 128, 235, 240, 242, 251, 296, 298-313, 328, 329.
- Ideas, 81, 83, 112, 115, 125 n., 127, 136, 202, 204, 209, 272, 276, 280, 290.
- Identity, 130.
- Illusion, 25, 168, 170, 190, 213, 294, 297, 301, 303.
- Imagination, 6, 17, 63, 91, 179, 183, 298, 299, 304.
- Imitation, reflective, 192, 261, 276, 323, 324 n., 325, 326, 328; social, 27, 136, 177, 178, 185-192, 195, 202, 274, 275, 295; spontaneous, 164, 207, 270, 305; provoke imitation, 272-282.
- Immigration, 100, 114, 135, 137, 156, 158, 281.
- Immortality, 119, 229; of achievement, 228-229, 316, 324 n.; social, 91, 167, 224, 256.
- Improvvidence, 157.
- Impulse, 27, 80, 126 n., 134, 172, 194, 195, 198, 221, 241.
- In-breeding, 157.
- Income, 153.
- Independence, 154.
- Individual, 34, 123, 131, 149, 167, 238, 289, 324, 325.
- Individualism, Individuality, 31, 33, 34, 63, 96, 118, 173, 190, 276, 281, 330.
- Individuation, 171.
- Induction, Inductive, 31, 42, 46, 111, 120, 158.
- Industrial, Industrialism, Industry, 9, 14 n., 33, 34, 48, 91, 114, 132, 136, 153,

- 155, 165, 167, 189, 221, 241, 247, 248, 252; -revolution, 103.
- Inequality, 26, 104, 143, 163, 206, 296.
- Infancy, prolongation of, 214, 309.
- Infanticide, 64, 154.
- Ingenuity, 179.
- Inheritance, 33, 57, 67, 69, 154, 178, 245.  
*See also* Use-inheritance.
- Initiative, 287.
- Injustice, 144.
- Innovation, Innovator, 136, 178, 229, 235, 257, 274, 295, 325, 328.
- Insects, 63-65.
- Instinct, Instinctive, 9, 25, 57, 63, 65, 77, 78, 81, 83, 87, 159, 163, 194, 216, 231, 238, 244, 257, 308, 321.
- Institutions, 33, 36, 83, 100, 103, 105, 116, 125, 126, 127, 135, 152, 153, 161, 174, 175, 191, 197, 206, 226, 240, 272, 274, 308, 327, 330, 331.
- Integration, 20, 32, 35, 36, 128, 186, 322, 327.
- Integrity, 87.
- Intellect, Intellectual, 15, 21, 25, 27, 39, 64, 65, 79, 105, 113, 115, 134, 177, 209, 217, 222.
- Intelligence, 23, 39, 82, 94, 100, 124, 131 n., 169, 179, 194, 200, 210, 211, 224, 270, 274, 275, 276, 282, 311, 312.
- Intemperance, 119.
- Interests, 10, 11, 21, 31, 113, 126, 132, 136, 142, 170-178, 248, 310, 311, 321, 326, 327; self-, 90, 91, 174, 182, 183, 241, 261, 277, 280. *See also* Conflict of interests.
- Interference, 297.
- Intuition, Intuitional, Intuitionalism, 105, 108, 173, 254, 303, 329 n.
- Invention, 161, 187, 197, 221-267, 311.  
*See also* Innovation.
- Isolation, 59, 61, 68, 73, 77, 112, 118, 157, 169.
- James, W., 146, 287-291.
- Judgment, 154, 183, 194, 306, 325.
- Justice, 129, 154, 163, 168, 246, 274, 279, 294.
- Keller, A. G., 316, 317 n.
- Kingdom of God, 256, 329.
- Knowing, Knowledge, 3, 20, 109, 131, 154, 164, 169, 239, 277, 330.
- Labor, Laborers, 104, 120, 156, 186, 247-249, 258. *See also* Division of labor.
- Laissez faire*, 40, 85, 152, 183, 281.
- Lamarck, J. B., 21, 30, 56-58, 70, 314.
- Language, 33, 63 n., 114, 116, 117, 137, 151, 158, 163, 228, 272.
- Lapouge, V., 99-102.
- Law, 43, 47, 91, 136, 142; definition of, 17, 110; biological or organic, 57, 76; cosmic or natural, 15, 17, 22, 23, 24, 32, 34, 44, 85, 86, 107, 108, 162-165, 185, 201, 212, 225, 274 n.; divine, 245, 259, 312; economic, 248-250; Mendelian, 72, 73; mental, 23, 27, 104-106, 192-199; moral, 24; penal, 254; social, 21-26, 106, 140, 164, 167, 170, 185-192, 277; statistical, 44; of the Three Periods, 16, 17, 20, 26.
- Leader, Leadership, 128, 177, 268.
- Leisure, 3, 112, 242, 260.
- Liberal, Liberalism, 30, 206, 278.
- Liberty, 36, 118, 206, 281, 332. *See also* Freedom.
- Life, 19, 34, 57, 118, 127, 132, 170, 213, 234, 245, 277, 287, 308, 324, 328, 332; duration of, 21, 88; life-force, 125; simple, 248; spiritual, 124.
- Like-mindedness, 203-205. *See also* Consciousness of kind.
- Lilienfeld, P. von, 47-49, 123, 126, 151.
- Literature, 110, 228, 272, 301.
- Loyalty, 235, 274, 279, 290.
- Logic, Logical, 18, 43, 50, 105, 159, 190, 260.
- Love, 12, 25, 153, 172, 181, 200, 201, 242, 270, 271, 306, 328.
- Luck, 152, 308.
- Lyell, Sir Charles, 30, 58.
- Mackenzie, J. S., 123, 128-133, 319 n.
- Mackintosh, R., 16, 39.
- Maine, Sir Henry, 178.
- Malthus, T. R., 58, 64, 248, 253.

- Man, 25, 87, 132, 146, 206, 222; average man, 45, 198, 301; origin of, 79, 208-213; *see also* Primitive; Great Man theory, 160, 219, 283-286.
- Marriage, 59, 93, 96, 110, 118, 258.
- Marx, Karl, 103-105, 181.
- Masses, 87, 132, 134, 136, 137, 153.
- Material, Materialism, Materialistic, 13, 15, 20, 103, 127, 146, 227, 331.
- Maternity, 200.
- Matter, 19, 41, 162, 208, 211, 320.
- McDougall, Wm., 146, 201, 211, 308, 321 n.
- Mechanical, Mechanism, Mechanistic, 38, 124, 138, 168, 170, 190, 208, 230.
- Meliorism, 132, 248.
- Memory, 63, 237.
- Mendel, Mendelian, 71-73, 88, 116, 314.
- Mental, 93, 124, 148, 155, 228. *See also* Capacity; Laws, mental.
- Merit, 250.
- Metaphysics, Metaphysical, 15-20, 246.
- Method, 7, 13, 15, 17, 41-51. *See also* *modifying word*.
- Methodology, 41-51.
- Might, 84, 153-155.
- Migration, 112, 113, 118, 175, 273.
- Militarism, Militancy, Military, 4, 14 n., 33, 100, 128, 135, 262 n., 292.
- Mill, J. S., 13, 17, 42, 182.
- Mind, 23, 41, 107, 111, 130, 151, 162, 186, 206, 210, 211, 234 n., 320, 331; general, 23, 26; social, 17, 133-147, 206, 318.
- Misery, 91, 250.
- Mob, 194.
- Moderation, 177.
- Modification, 23, 74, 79, 113, 221, 223, 237. *See also* Variation.
- Monism, Monistic, 22, 125, 146, 162, 208, 210, 212, 213, 214, 233, 309, 310.
- Monogamy, 36, 159.
- Monopoly, 255.
- Montesquieu, Baron de, 13, 15, 21.
- Moral, Morals, Morality, 15, 20, 22, 34, 37, 65, 80, 81-85, 95 n., 100, 106, 109-110, 152, 159, 163, 168, 174, 206, 216, 242, 247, 272, 326 n.
- Mores, 140, 231, 254, 310.
- Morgan, T. H., 63, 66 n., 69.
- Motive, 125 n., 159, 174, 202, 243, 251, 254, 260, 272.
- Motor, 239.
- Münsterberg, H., 191.
- Mutation, 63, 70, 209, 288.
- Mutual aid, 78, 125.
- Mystery, 153, 185, 212, 303, 307, 309.
- Mysticism, 275, 308, 309.
- Nation, National, Nationality, 23, 32, 44, 93-99, 117, 127, 134, 138, 144, 158, 175, 179, 189, 224, 234, 241, 246, 255, 256, 272, 280.
- Nature, Natural, Naturalism, 19, 20, 59, 110, 112, 115, 119, 126 n., 129, 132, 222, 304; "Nature v. Nurture," 92-99, 116-119, 232; niggardliness of, 247.
- Needs, 5, 57, 129 n., 131, 136, 159, 187, 213, 234, 280, 293, 310, 325. *See also* Desires, Interests.
- Negro, 94, 156 n., 158.
- Neo-Darwinian, 93, 152, 159, 237, 245, 281, 294, 315-317.
- Neo-Lamarckian, 207, 222, 237.
- Nietzsche, F., 80-85, 91, 101, 191, 253.
- Nordau, Max, 94, 288 n.
- Norm, Normal, 89, 136, 140, 143, 148, 153.
- Novicow, J., 202, 268-282, 319, 320, 324 n.
- Nurture, 116. *See also* Education, Environment, "Nature v. Nurture."
- Nutrition, 116, 199.
- Obedience, 284, 305.
- Observation, 19, 23, 42, 46, 153.
- Occupation, 114, 116, 119.
- Opinion, 22, 205; public, 261, 294, 296, 306.
- Opportunism, 21, 24.
- Opportunity, 144, 155-159, 280, 296, 316.
- Opposition, 185, 187, 198.
- Oratory, 301.
- Order, 15, 19, 20, 131 n., 132, 178, 212, 294, 299, 302, 328.

- Organic, 18, 20, 47, 56, 125, 127, 212; super-organic, 32-33; quasi-organic, 221. *See also* Evolution, organic.
- Organism, 91, 129, 173; biological, 8, 19, 23, 55-57, 78, 188; quasi-biological, 31; fictitious, 18; psychological, 23; quasi-psychological, 41; social, 16, 23-28, 30-35, 47-49, 87-89, 123-147, 185.
- Organization, 31, 32, 33, 39, 62, 84, 87, 91, 132, 144, 155, 175, 215, 255, 270, 280, 322, 324, 329.
- Origin, of man, 78, 79, 150, 162, *see* Primitive; of species, 56-78, 164-170; *see* Evolution, biological; social origins, 41, 163.
- Osborn, H. F., 7, 61.
- Pain, 79 n., 128, 130, 153, 183, 184, 216, 227, 240, 272, 274, 279.
- Pangenesi, 67.
- Palmer, G. H., 280.
- Parallelism, 211 n., 212, 239.
- Parasite, 295.
- Parties, 126, 331.
- Pascal, 16, 127.
- Passion, 302.
- Paternalism, 110.
- Pathological, Pathology, 42, 8 120, 123, 128.
- Patriotism, 235, 252.
- Patten, Simon N., 236-244.
- Peace, 267, 331.
- Pearson, Karl, 92-99, 326.
- Perfect, Perfection, 37, 126, 130, 215, 226, 238, 280, 292, 301, 319 n.
- Person, Personal, 195-199, 274, 294, 306, 307, 331.
- Personalism, 233, 321; social, 320-331.
- Personality, 15, 16, 48, 143, 145, 148, 149, 175, 189, 195, 205, 284, 307-310, 327; quasi-personality, 45, 48, 196, 198, 311, 326, 328, 331; cosmic, 225; divine, 307; social, 48, 145, 148, 149, 196-198, 320-325.
- Personification, 307-309.
- Persuasion, 277, 325.
- Phenomenal, 16, 171.
- Philosophy, Philosophical, 25, 82, 124, 211; social, 3-10, 14, 181, 192, 211-213, 228, 234, 235, 271, 299, 325, 326.
- Pigmentation, 55, 114, 118.
- Play, 195, 206.
- Pleasure, 79 n., 128, 130, 153, 183, 184, 231, 234, 238-244, 255, 256, 272, 274, 277, 315, 324 n.
- Pluralism, 146, 189, 287.
- Poets, Poetry, 276, 300.
- Political, Politics, 14 n., 21, 22, 23, 24, 33, 48-49, 113, 179, 206, 247, 296, 331; factors, 47, 49; institutions, 100; opportunism, 21; parties, 100, 113; progress, 35; power, 272, 280.
- Pomp, 295.
- Poor, Poverty, 91, 112, 296.
- Population, 20, 21, 33, 58, 64, 116, 118, 132, 163, 167, 175, 179, 248, 250, 330.
- Positive, Positivism, 12-20, 128.
- Posterity, 126.
- Power, 20, 64, 88, 154, 159, 241, 327, 328.
- Pragmatic, Pragmatism, 26, 169, 170, 233, 287, 328.
- Prayer, 290, 312.
- Pressure, social, 38, 167, 177, 306.
- Prevision, 269.
- Primitive, 6, 17, 32, 84, 87, 90, 107, 114, 134, 151, 152, 155, 162, 178, 209, 255, 307, 311, 315.
- Principle, 20, 179, 181.
- Process, the cosmic, 208, 215, 245; the social, 32, 126, 127; *see also* Evolution, Progress; society as a, 145.
- Production, Productivity, 33, 113, 138, 153, 167, 176, 213, 221-263, 269-271, 278, 280, 329, 330.
- Profit, 295.
- Progress, 3-11, 13, 19-25, 32, 34, 65, 82, 86, 106, 109, 118, 128, 132, 136, 153, 155-159, 165, 183, 190, 229, 240, 243, 291-295, 298, 299; tests of, 20-25, 34, 36, 214, 234, 245-255, 275, 297, 323-331. *See also* Development, Evolution.
- Promiscuity, 36. *See also* Family.
- Propaganda, 270, 278.
- Property, 176, 250-251.

- Prophecy, Prophet, 27, 324, 330.  
 Proportionality, law of, 248, 307.  
 Prosperity, 167, 176, 183.  
 Providence, 188.  
 Psychic, Psychological, Psychological, Psychology, 9, 20, 22, 33, 38, 41, 74, 105, 108, 114, 123, 125, 127, 133, 167, 192, 210, 215, 234, 236, 256, 261, 269, 327.  
 Punishment, 141, 142.  
 Purpose, Purposeful, 9, 37, 79, 101, 124, 125, 128, 144, 145, 171, 194, 204, 221, 260, 269, 319, 327.  
 Quêtelet, L. A. J., 43-46, 106.  
 Race, 21, 22, 106, 115-120, 133-137, 164, 175, 178, 180, 194, 209, 223, 224, 240, 244, 260, 281, 315, 318; definition of, 99, 116, 133; degeneration or extinction of, 95, 96, 98, 99, 135, 166, 224, 259; improvement of, 81, 93, 101, 103, 118, 224-226, 261, 330; survival of, 36; variability of, 94; race-crossing, 119, 158. *See also* Cross-breeding.  
 Rational, 28, 29, 129, 154, 159, 202, 206. *See also* Reflective.  
 Ratzel, F., 111-115.  
 Ratzenhofer, Gustav, 21, 146, 170-178, 187, 234.  
 Real, Reality, Realism, 27, 38, 50, 138, 146, 149, 299, 301; social realism, 22, 23, 47, 138, 144, 327.  
 Reason, 24, 48, 59, 63, 90, 91, 131, 132, 174. *See also* Intellect.  
 Recapitulation, 23, 48, 126, 197.  
 Recognition, 204.  
 Reconstruction, 5, 16, 23, 207.  
 Reflection, Reflective, 153, 193, 204, 207, 302, 320, 323, 326, 329.  
 Reflex, 78, 134.  
 Reformer, 9, 257.  
 Regeneration, social, 6, 92-102, 224.  
 Regress, 292.  
 Relativism, Relativity, 3, 12, 20, 21, 27, 37, 38, 85, 104, 110, 288, 301.  
 Religion, Religious, 20, 25, 34, 37, 63, 81, 90-93, 96, 100, 110, 125, 136, 137, 141, 163, 169, 180, 198, 200, 209, 215, 217, 235, 242, 245, 252, 272, 286, 299-313, 325; social, 294, 303, 308.  
 Rent, 249.  
 Reorganization, 14, 189. *See also* Reconstruction.  
 Repentance, 260.  
 Reproduction, 171, 199.  
 Resignation, 169.  
 Responsibility, 213, 250, 326.  
 Responsiveness, 203.  
 Restraint, 144. *See also* Constraint.  
 Retrogression, 36. *See also* Degeneration.  
 Reverence, 308, 309.  
 Revolution, industrial, 103, 104.  
 Rhythm, 39, 242, 270, 279. *See also* Cycle.  
 Ricardo, D., 249.  
 Rich, Riches, 254, 259, 272, 274, 280. *See also* Wealth.  
 Right, Rights, 84, 126 n., 138, 140-143, 152, 153, 163, 168, 198, 257, 271, 273.  
 Ripley, W. Z., 115-120.  
 Rite, 152.  
 Rivalry, 87, 241, 255, 263, 268, 278, 280, 282. *See also* Conflict, Competition, Struggle.  
 Ross, E. A., 4, 27, 155, 291-297, 301-304.  
 Rousseau, J. J., 13, 15.  
 Royce, J., 30, 213 n.  
 Sacrifice, 85, 88, 90, 91, 92, 302, 311, 322, 331.  
 Saint-Simon, 13, 14 n., 16.  
 Sanctions, 85, 92; biblical, 262; personal, 198; religious, 256; social, 198; super-rational, 27, 90, 92.  
 Satisfaction, 131, 329.  
 Savage, Savagery, 151, 216, 223. *See also* Primitive.  
 Scarcity, economic, 245-260.  
 Schäffle, A., 47, 123-128, 133, 138, 146.  
 School, 140, 154, 189, 217.  
 Schopenhauer, A., 82, 229.  
 Science, Scientific, 16, 17, 18, 85, 125, 158, 200, 211, 228, 234, 268, 272, 276, 304; Christian, 290; hierarchy of, 17, 49; historical, 28, 105; natural, 162; social, 4, 8, 49, 128, 186, 248.

- Security, 278.  
 Segregation, 117, 296.  
 Selection, 242, 258, 297; artificial, 71, 101, 117, 120, 258; conscious, 157; germinal, 69; natural, 33, 39, 50, 59-68, 73-79, 82, 87, 118, 125, 169, 185, 193, 211, 225, 237; organic, 75, 193; sexual, 59, 66, 118; social, 92-101, 115, 118, 153, 154, 164, 241, 255, 316-318; urban, 118.  
 Self, Selves, 111, 130, 146, 280, 304, 305, 324, 327.  
 Self-consciousness, *see* Consciousness.  
 Self-denial, 85.  
 Self-development, 170, 324-326.  
 Self-esteem, 301.  
 Selfish, Selfishness, 200, 214, 321.  
 Self-preservation, 126 n., 324.  
 Self-realization, 133, 170, 319 n.  
 Self-satisfaction, 311, 325.  
 Semple, Ellen C., 111-115.  
 Sensation, Sensory, 187, 237, 239.  
 Sentiment, 21, 82, 134, 136, 140, 175, 183, 191, 222, 236, 273, 306; self-regarding, 91, 147, 149, 221, 261, 326; of safety, 232.  
 Service, 242, 259, 274, 301, 324.  
 Sex, Sexual, 142, 154, 178, 200, 223, 244.  
*See also* Selection, sexual.  
 Skill, 330.  
 Slavery, Slaves, 110, 113, 154, 176, 178, 250, 271, 295.  
 Small, A. W., 21, 50 n., 124.  
 Smith, A., 13, 182-184.  
 Social (*see in Index the particular word modified by this adjective*).  
 Socialism, Socialistic, 90, 96, 133, 244, 251, 308.  
 Sociality, 216, 294.  
 Socialization, 187.  
 Society, Societies, 16, 19, 31, 45, 47, 48, 82, 120, 123, 127, 139, 145, 168, 196-198, 201, 274, 296, 323, 326, 331.  
 Sociological, Sociology, 3-11, 17, 31, 42, 87, 120, 139, 163, 167, 186, 222, 227, 233, 245. *See also* Philosophy, social, Science, social.  
 Socius, 150, 206, 327.  
 Solidarity, 138-143, 193, 276, 279, 303.  
 Solitude, 298.  
 Soul, 133, 136, 185, 215, 216, 222.  
 Specialization, 223, 322. *See also* Individuality.  
 Species, 9, 19, 31, 44, 56, 62, 69, 89, 215; modification of, 78, 86; origin of, 56-78, 164, 170, 189, 215; unit in selection, 63, 69, 77, 90.  
 Speech, 209.  
 Spencer, H., 6, 17, 23, 29-40, 41, 49, 50, 63, 106, 123, 124, 128, 152, 157, 162, 217, 253, 275 n., 287, 313.  
 Spirit, Spiritual, Spiritualistic, 15, 24, 124, 127, 148, 212, 227; *see under* Adaptation, Environment, Life.  
 Spontaneous, 193.  
 Sport, 230, 235, 288.  
 Standard, 5, 38, 62, 109, 144, 152, 153, 260, 302; of living, 241, 250, 263. *See also* Test.  
 State, 134, 140, 144, 178, 236, 278, 281, 295, 322. *See also* Nation.  
 Static, 3, 19, 31, 89, 146-147.  
 Statistics, 43-46, 105, 143, 186.  
 Stature, 114, 116.  
 Status, 178.  
 Stratification, 117, 134.  
 Structure, 26, 32, 62, 123, 127, 142, 145, 157, 170, 194, 223, 226.  
 Struggle, 168, 171, 174-176, 226, 243, 246-261, 268-282; class, 103-105, 164-165; economic, 255-256, 270; for achievement, 199; for development, 171; for excellence, 267-279, 320; for existence, 3, 33, 59-70, 76 n., 78, 79, 82, 86, 132, 171, 238, 243, 246, 279; for the life of others, 199; hierarchy of, 267-279; inter-group, 36, 87, 96, 163, 263. *See also* Competition, Conflict, Mal-adaptation, Rivalry.  
 Subsistence, 64, 89, 175, 177, 248.  
 Success, 87, 213, 235, 250, 275, 308, 316, 325, 328.  
 Suggestion, 186, 198, 230, 294, 305, 306. *See also* Imitation.  
 Sumner, W. G., 49, 153-155, 288 n.



- Super-group, 85, 245-263.  
 Super-man, 80-85, 101.  
 Supernatural, Supernaturalism, 239, 304.  
 Super-organic, 33, 38, 123.  
 Super-rational, 85-91.  
 Superstition, 226, 295.  
 Surplus, 47, 104, 231, 237-244, 250-254, 330.  
 Survival, 36, 152, 188, 239, 281, 292-294.  
*See also* Struggle, Selection.  
 Symbols, 39, 302.  
 Sympathy, 3, 65, 182, 200-217, 271, 291, 294, 302, 327.  
 Synergy, 225, 226, 229.  
 Synthesis, 19, 30, 137, 148, 201; creative, 224.  
 Tarde, G., 137, 185-192.  
 Taste, 154.  
 Teacher, 9, 186, 249.  
 Telic, Teleological, Teleology, Telesis, 9, 27, 38, 50, 125, 143, 160, 167, 188, 192, 222, 227, 231, 234, 295. *See also* Purpose, Purposeful.  
 Temperament, 114, 144, 303.  
 Temperance, 65.  
 Tests, of good and true, 255, 287, 329; of religion, 26, 329; of social philosophy, 214, 329; of social progress, *see* Progress.  
 Theism, 309.  
 Theological, Theology, 15, 17, 20, 25, 129.  
 Thomas, W. I., 152 n., 160.  
 Thomson, Sir A., 39, 70.  
 Thorndike, E. L., 151, 201.  
 Thought, 136, 206, 233, 243, 269, 287, 299, 305, 327.  
 Time, 113, 155, 271, 279, 282.  
 Tolerance, 179.  
 Tools, 33, 63, 228, 270.  
 Trade, free, 280.  
 Tradition, 21, 27, 133, 205.  
 Training, 23, 96, 144, 194, 255, 289, 316, 330.  
 Traits, 94, 155-158.  
 Transcendental, 173-174, 309.  
 Tropism, 78.  
 Truth, 5, 25, 189, 214, 279, 287, 327, 329.  
 Type, 19, 44, 45, 46, 89, 94, 99, 115, 124, 135, 139, 156, 180, 205, 206, 209, 276, 301.  
 Union, Unity, 5, 6, 8, 15, 16, 30, 114, 127, 131, 248, 287, 309; kinds of, 129-131; social, 23, 123, 126, 128, 133, 136, 137, 142, 144, 147, 180, 198, 235, 323-330. *See also* Alliance, Coöperation, Federation.  
 Unit, sociological, 23, 32, 123, 125, 153, 189, 206, 236, 246, 249, 260, 272.  
 Unlikeness, 205.  
 Unselfish, 200.  
 Urbanization, 100.  
 Use-inheritance, 39, 56, 59, 64, 67, 75, 95, 178, 222, 237.  
 Utilitarian, Utilitarianism, 5, 159, 254.  
 Utility, Utilization, 36, 63, 84, 88, 141, 142, 152, 183, 202, 207, 222, 236, 241, 257, 291, 295, 301, 325, 329.  
 Utopias, 5, 101, 299, 300.  
 Value, Valuation, 85, 104, 109, 125, 153, 159, 212, 249, 303, 327.  
 Vanity, 184.  
 Variation, Variability, 84, 107, 292, 325; biological, 45, 55, 60, 61, 70, 89, 94, 107, 116, 164, 209, 288; psychical, 215; social, 45, 113, 136, 157, 178, 185, 187, 189, 229, 231, 235, 288, 325. *See also* Innovation, Invention, Genius.  
 Variety, 63.  
 Vice, 50, 66, 107, 118, 254.  
 Vigor, 87, 93, 96.  
 Volition, 145, 187, 204, 298.  
 Wages, 104, 242, 248, 258.  
 Wallace, A. R., 59, 64, 67.  
 War, Warfare, 113, 134, 176, 247, 250, 262, 263, 277, 302. *See also* Conflict, Struggle.  
 Ward, Lester F., 4, 17, 21, 27, 31, 50, 151, 213-215, 221-236, 311.  
 Waste, 176, 241, 253, 258, 263, 329.  
 Wealth, 3, 26, 104, 112, 138, 176, 213, 228, 243, 251, 256, 274, 330.

- Weismann, A., 56, 64 n., 67, 68-70, 86, 88, 93, 96.
- Well-being, Welfare, 25, 34, 110, 128, 130, 131, 132, 143, 153, 184, 213, 229, 240, 241, 256, 258, 260, 263, 297, 302, 325, 326, 329-331.
- Wesley, J., 298.
- Westemarck, E., 159.
- Will, 82, 168, 175, 186, 207; free, 45, 58, 106, 211, 213, 227, 233, 235, 286; *see* Choice; of God, 37, 215, 245, 259, 311; to live, 82-88, 106; to power, 80-85, 175; social, 48, 175, 207.
- Willing, 108, 131.
- Wisdom, 304.
- Woman, 275, 300, 301 n.; suffrage, 257.
- Work, 231, 278.
- World, 34, 36, 129, 131, 133, 200.
- Worship, 301.
- Worth, 126, 285, 295, 325, 331.
- Wundt, W., 138.



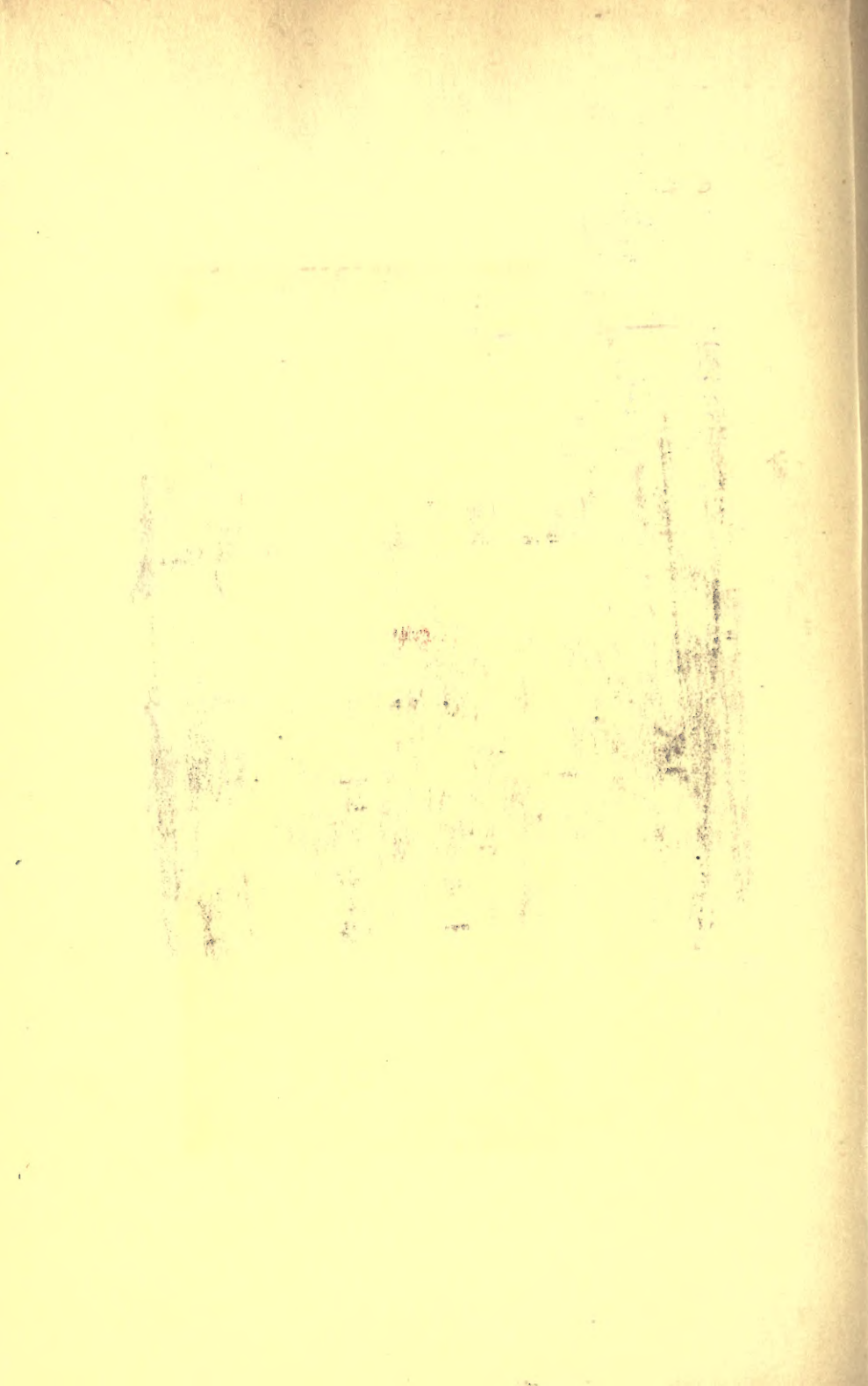

HM  
106  
B75  
1921

Bristol, Lucius Moody  
Social adaptation

PLEASE DO NOT REMOVE  
CARDS OR SLIPS FROM THIS POCKET

---

UNIVERSITY OF TORONTO LIBRARY

---

